



VeHuro
SALES & PRODUCTION

GENERAL INSTRUMENTS



Wir behalten uns vor, Änderungen und Verbesserungen durchzuführen und die Instrumente und Geräte ohne besonderen Hinweis in der modifizierten Ausführung auszuliefern.

Die Verwendung dieses Kataloges zu anderen Zwecken als ausschließlich der zum Vertrieb von VeHu Produkten ist untersagt. Zuwiderhandlungen werden rechtlich geahndet. Der Nachdruck, auch auszugsweise, ist verboten.

We reserve the right of technical modifications and improvements and to supply the instruments and apparatus without specific indication in the modified finish.

The use of this catalogue is restricted to actions necessary for selling original **VeHu** products. The use for any purpose other than selling original **VeHu** products is prohibited and will be prosecuted. Reprinting, even partially, is not allowed.



Willkommen bei VeHu

Sie kennen uns (noch) nicht? Wir sind ihr kompetenter Partner für die Veterinär- und Humanmedizin.

Denn wir bieten das komplette Programm an chirurgischen Instrumenten direkt aus Tuttlingen - dem weltzentrum der Medizintechnik. Neben dem Vertrieb konzentrieren wir uns auf unsere Produktionsstätte –MRitter&Sohn GmbH in der wir hochpräzise chirurgische Instrumente entwickeln und fertigen – selbstverständlich auch kundenspezifische Aufträge. Sowohl die Produkte aus unserer eigenen Herstellung und die Komponenten von ausgewählten Lieferanten, obliegen konsequent unserer strengen Kontrolle, Prüfverfahren und langjähriger Erfahrung. So wird die gleichbleibende hohe Qualität aus unserem Hause gesichert und bereitgestellt. Für die hohe Anforderung in der Medizin.



Welcome to VeHu.

You don't know us yet. We are your competent partner for veterinary and human medicine. We offer the entire range of surgical Instruments. Our headquarter is located in Tuttlingen, the world center of medical technology. In addition to sales, we concentrate on our production site- MRitter&Sohn GmbH-in which we develop and manufacture high-precision surgical instruments- Of course, also custom orders.

Both the products of our own production and the components of selected suppliers are consistently subject to our strict control, testing procedures and many years of experience. This way the constant high quality from our company is secured and made available.

For the high requirement in the medicine.



VeHu-Medical ist seit 2000 erfolgreich im medizinischen Bereich tätig. Wir bieten das komplette Sortiment chirurgischer Instrumente an. **VeHu-Medical** wurde ursprünglich im Jahr 2000 von Frau Claudia und Herrn Peter Kraut gegründet und wechselte 2015 zu MRitter & Sohn, zu einem etablierten Hersteller von chirurgischen Instrumenten. Der mittlerweile über zwei Generationen von Michael Ritter und Kevin Ritter geführt wird.

Michael Ritter, der seine über drei Jahrzehnte lange Erfahrung in der Herstellung von chirurgischen Instrumenten einbringt und nach höchsten Qualitätsstandards herstellt. Die allen nationalen und internationalen Normen und Vorschriften entsprechen.

Auch im Vertrieb, steht unsere Philosophie und Marke für herausragende Qualität. Einen Kundenservice mit persönlicher Beratung und zuverlässigen Service gewährleistet. Das Produkt und die Erwartungen unserer Kunden stehen im Mittelpunkt und Fokus aller unserer Aktivitäten, um die Erwartungen, Wünsche und Anforderungen unserer Kunden auf höchstem Qualitätsniveau zu erfüllen.

Unsere Datenbank umfasst 15.000 Standardartikel. Obwohl unser Lagerbestand in den letzten zwei Jahren verdoppelt wurde, fügen wir unserer Standardbestandsmenge kontinuierlich weitere Artikel hinzu, um die kürzeste Lieferzeit für unsere Kunden sicherzustellen.

Unser Logistiksystem wurde an den neusten Stand der Technik angepasst und verfügt über eine geschulte Mitarbeiterzahl von mehr als 10 Mitarbeitern im Vertrieb und in der eigenen Produktion, um die tägliche Einhaltung der Produktionsqualität und Lieferzeiten sicherzustellen. All dies spiegelt sich in unserer Flexibilität und Verfügbarkeit für jeden Kundenwunsch in Verbindung mit einem hervorragenden Preis-Leistungs-Verhältnis wider.

Um die Einhaltung aller verbindlichen internationalen Standards zu gewährleisten, sind wir selbstverständlich ein nach DIN ISO 13485: 2016 und US-amerikanischen FDA zertifiziertes Unternehmen.



Since 2000, **VeHu-Medical** has been successfully active in the medical sector. We offer a complete range of surgical instruments.

VeHu-Medical was originally founded by Mrs. Claudia and Mr. Peter Kraut in the year 2000 and changed ownership in 2015 to MRitter & Sohn, a well established manufacturer of surgical instruments with the professional expertise of Michael Ritter and Kevin Ritter meanwhile over 2 generations of manufacturing surgical instruments of the highest quality standards complying with all national and international standards and regulations. After almost 2 decades of professional experience in manufacturing of surgical instruments, as well as the sales and distribution, our philosophy and brands stands for outstanding quality, a customer service with personal approach and advise and of course reliable on-time delivery are our strengths and ensure customer comprehensive and reliable service.

The product along with our customers expectations are the center and focus of all activities in order to meet our clients expectations, wishes, demands and requirements on the highest quality levels. Our database includes 15.000 standard articles and despite our stock value has been doubled over the last two years, we continuously adding more articles to our standard stock quantity to ensure the shortest possible delivery time for our clients. Our store and logistic system has been adapted to the last state-of-the-art requirements, along with a professional trained staff size of more then 10 employees in sales and own production to ensure production quality and delivery time compliance on daily bases. All of the above is reflected by our flexibility and availability for any customer demand in combination with an excellent price-performance ratio.

In order to ensure the compliance with all mandatory international standards we are, of course, a certified DIN ISO 13485:2016 and US FDA registered company.

Skalpellklingen, Skalpellgriffe, Messer
Scalpel Blades, Scalpel Handles, Knives
Hojas de bisturíes, Mangos de bisturíes, Cuchillos
Lame per bisturi, Manici per bisturi, Coltelli

Sterile Skalpelling, Skalpellinggriffe
Sterile Scalpel Blades, Scalpel Handles
Hojas de bisturíes estériles, Mangos de bisturíes
Lame per bisturi sterili, Manici per bisturi



No. 3
12,5 cm, 5"
106.103.00



No. 3
12,5 cm, 5"
106.103.01



No. 3L
21,0 cm, 8¼"
106.103.02



No. 7
16,5 cm, 6½"
106.107.00



No. 7K
13,0 cm, 5"
106.107.01



No. 4
13,5 cm, 5³/₈"
106.104.00



No. 4L
21,0 cm, 8³/₈"
106.104.02



No. 8
13,5 cm, 5³/₈"
106.108.00



No. 9
14,5 cm, 5³/₄"
106.108.09



Fig. 1 **106.402.01**
Fig. 2 **106.402.02**
Fig. 3 **106.402.03**
Fig. 4 **106.402.04**
Fig. 5 **106.402.05**



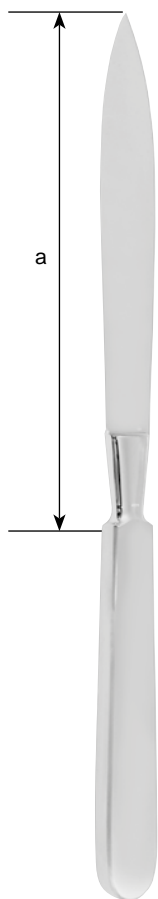
Fig. 15 **146.384.15**



OPERATION
17,0 cm, 6¾"

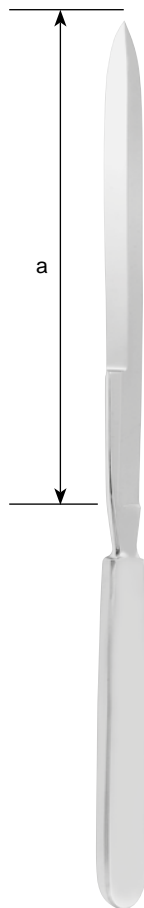


Fig. 6 **106.402.06**
Fig. 7 **106.402.07**
Fig. 8 **106.402.08**
Fig. 9 **106.402.09**
Fig. 10 **106.402.10**



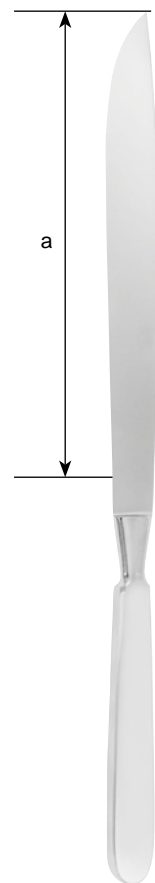
COLLIN

a	
13,0 cm, 5"	106.420.13
16,0 cm, 6 ¹ / ₄ "	106.420.16
19,0 cm, 7 ¹ / ₂ "	106.420.19
22,0 cm, 8 ⁵ / ₈ "	106.420.22
28,0 cm, 11"	106.420.28



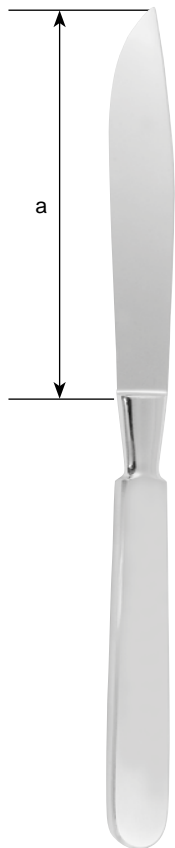
CATLIN

A	
16,0 cm, 6 ¹ / ₄ "	106.432.16
19,0 cm, 7 ¹ / ₂ "	106.432.19
22,0 cm, 8 ⁵ / ₈ "	106.432.22



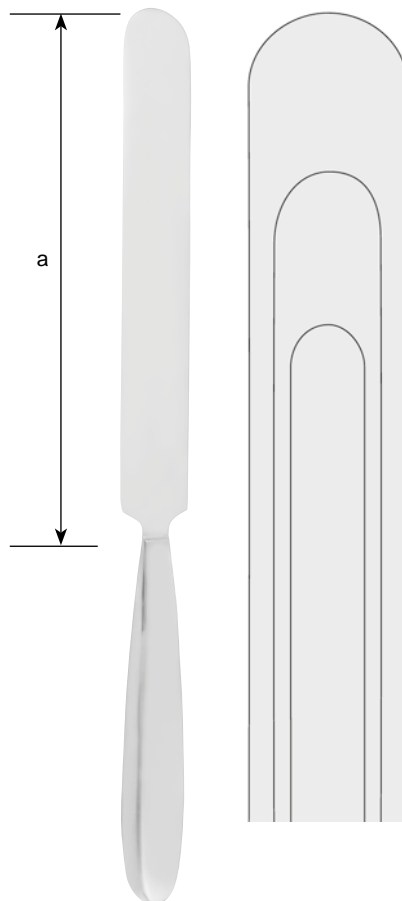
LISTON

A	
17,0 cm, 6 ³ / ₄ "	106.430.17
20,0 cm, 8"	106.430.20
22,0 cm, 8 ⁵ / ₈ "	106.430.22



LANGENBECK

A	
5,5 cm	106.410.15



VIRCHOW

A	
16,0 cm, 6 ¹ / ₄ "	106.980.16
20,0 cm, 8"	106.980.20
24,0 cm, 9 ¹ / ₂ "	106.980.24

Amputationsmesser, Dermatomye
Amputation Knives, Dermatomyes
Cuchillos para amputación, Dermátomos
Coltelli per amputazione, Dermatomyi



LANGENBECK
18,0 cm, 7"
106.410.05



CARTILAGE
18,0 cm, 6⁵/₈"
106.414.05

mit Schaber
with raspatory
con periostótomo
con raschiatoio

Haut-Spannplatten
Skin straightening plate
Placa para extender la piel
Placca per stendere la pelle



106.490.02

106.495.99
Ersatzklinge
Spare blade
Hoja de repuesto
Lama di ricambio



SILVER
19 cm, 7 1/2"
106.495.00

106.491.99
Ersatzklinge
Spare blade
Hoja de repuesto
Lama di ricambio



HUMBY
32,0 cm, 14"
106.491.00

106.490.01
Ersatzklinge
Spare blade
Hoja de repuesto
Lama di ricambio



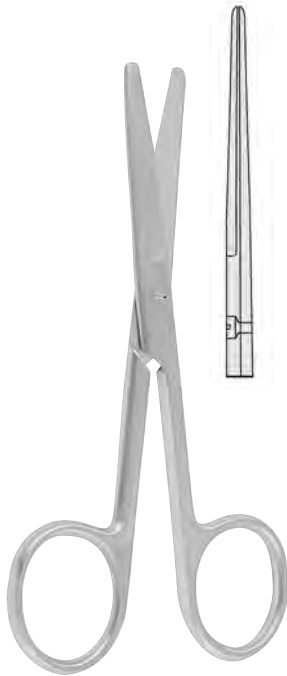
SCHINK
30,0 cm, 12"
106.490.00

Scheren

Scissors

Tijeras

Forbici



STANDARD

10,5 cm, 4 ¹ / ₄ "	108.102.10
11,5 cm, 4 ¹ / ₂ "	108.102.11
13,0 cm, 5"	108.102.13
14,5 cm, 5 ³ / ₄ "	108.102.14
15,5 cm, 6"	108.102.15
16,5 cm, 6 ¹ / ₂ "	108.102.16
18,5 cm, 7 ¹ / ₄ "	108.102.18
20,0 cm, 8"	108.102.20



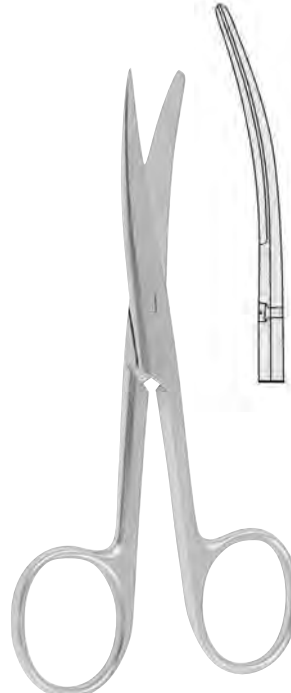
STANDARD

10,5 cm, 4 ¹ / ₄ "	108.103.10
11,5 cm, 4 ¹ / ₂ "	108.103.11
13,0 cm, 5"	108.103.13
14,5 cm, 5 ³ / ₄ "	108.103.14
15,5 cm, 6"	108.103.15
16,5 cm, 6 ¹ / ₂ "	108.103.16
18,5 cm, 7 ¹ / ₄ "	108.103.18
20,0 cm, 8"	108.103.20



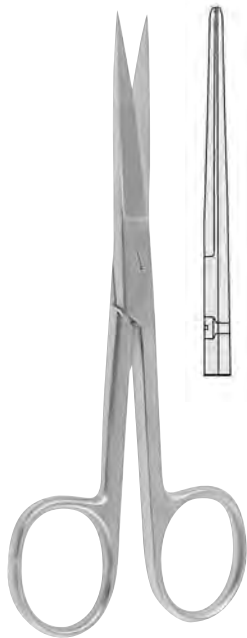
STANDARD

10,5 cm, 4 ¹ / ₄ "	108.110.10
11,5 cm, 4 ¹ / ₂ "	108.110.11
13,0 cm, 5"	108.110.13
14,5 cm, 5 ³ / ₄ "	108.110.14
15,5 cm, 6"	108.110.15
16,5 cm, 6 ¹ / ₂ "	108.110.16
18,5 cm, 7 ¹ / ₄ "	108.110.18
20,0 cm, 8"	108.110.20



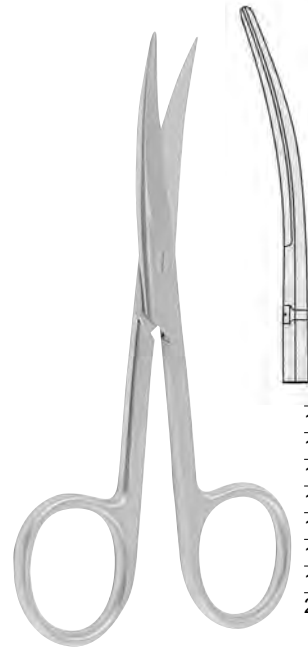
STANDARD

10,5 cm, 4 ¹ / ₄ "	108.111.10
11,5 cm, 4 ¹ / ₂ "	108.111.11
13,0 cm, 5"	108.111.13
14,5 cm, 5 ³ / ₄ "	108.111.14
15,5 cm, 6"	108.111.15
16,5 cm, 6 ¹ / ₂ "	108.111.16
17,5 cm, 6 ⁵ / ₈ "	108.111.17
18,5 cm, 7 ¹ / ₄ "	108.111.18
20,0 cm, 8"	108.111.20



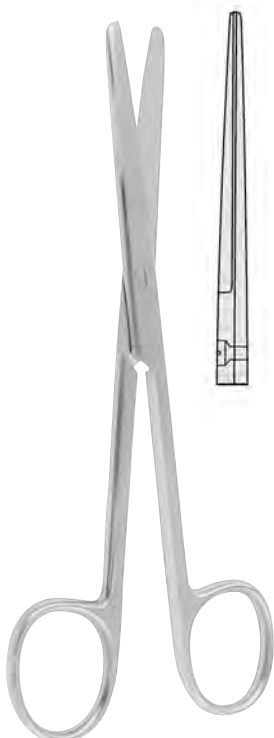
STANDARD

10,5 cm, 4 ¹ / ₄ "	108.120.10
11,5 cm, 4 ¹ / ₂ "	108.120.11
13,0 cm, 5"	108.120.13
14,5 cm, 5 ³ / ₄ "	108.120.14
15,5 cm, 6"	108.120.15
16,5 cm, 6 ¹ / ₂ "	108.120.16
18,5 cm, 7 ¹ / ₄ "	108.120.18
20,0 cm, 8"	108.120.20



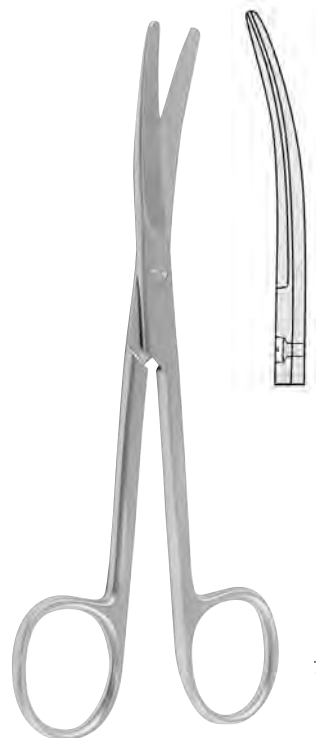
STANDARD

10,5 cm, 4 ¹ / ₄ "	108.121.10
11,5 cm, 4 ¹ / ₂ "	108.121.11
13,0 cm, 5"	108.121.13
14,5 cm, 5 ³ / ₄ "	108.121.14
15,5 cm, 6"	108.121.15
16,5 cm, 6 ¹ / ₂ "	108.121.16
18,5 cm, 7 ¹ / ₄ "	108.121.18
20,0 cm, 8"	108.121.20



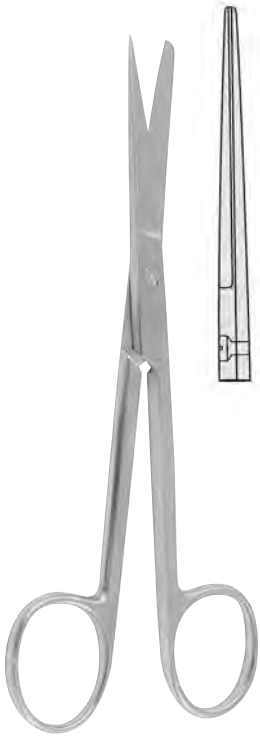
DEAVER

14,0 cm, 5 ³ / ₄ "	108.130.14
--	-------------------

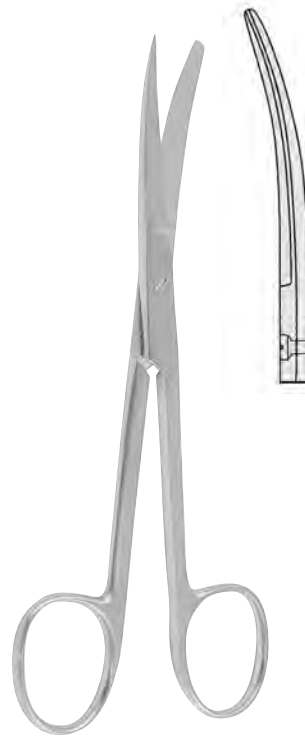


DEAVER

14,0 cm, 5 ³ / ₄ "	108.131.14
--	-------------------



DEAVER
14,0 cm, 5³/₄" **108.140.14**



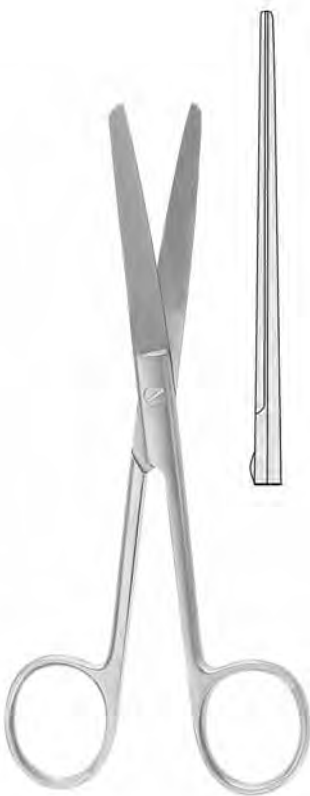
DEAVER
14,0 cm, 5³/₄" **108.141.14**



DEAVER
14,0 cm, 5³/₄" **108.150.14**



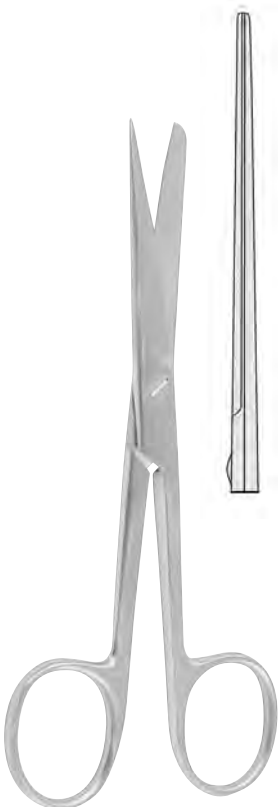
DEAVER
14,0 cm, 5³/₄" **108.151.14**



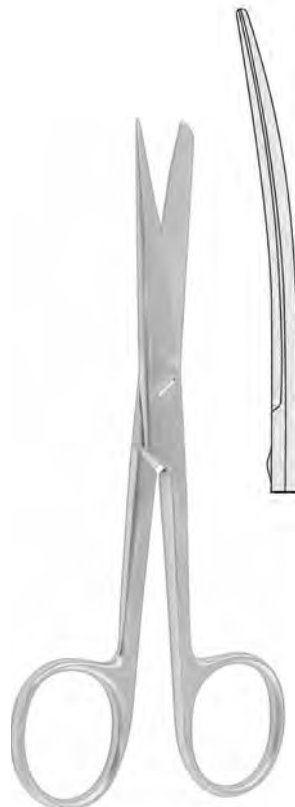
GRAZIL
14,0 cm, 5³/₄" **108.122.01**



GRAZIL
14,0 cm, 5³/₄" **108.123.01**



GRAZIL
12,0 cm, 5" **108.124.12**
14,5 cm, 5³/₄" **108.122.02**



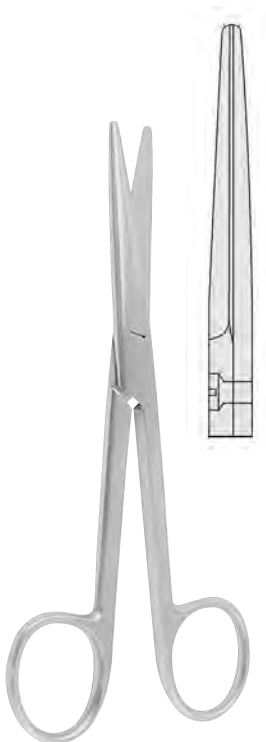
GRAZIL
12,0 cm, 5" **108.125.12**
14,5 cm, 5³/₄" **108.123.02**



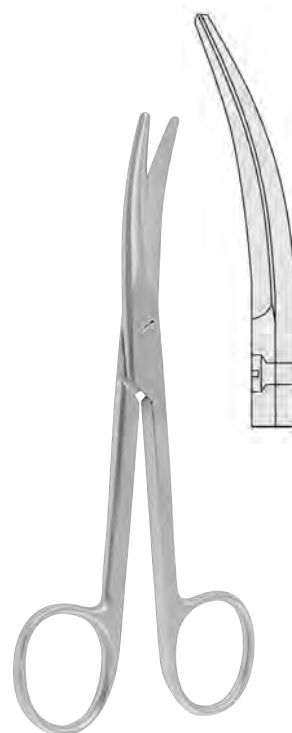
GRAZIL
 13,0 cm, 5" **108.126.13**
 14,5 cm, 5³/₄" **108.122.03**



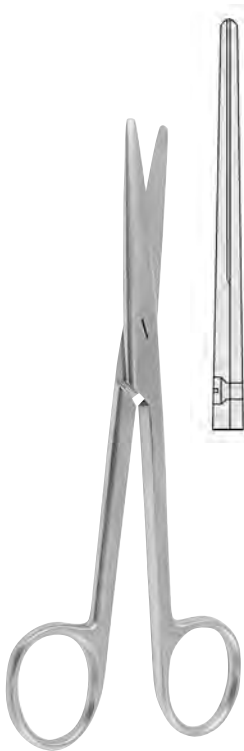
GRAZIL
 13,0 cm, 5" **108.127.13**
 14,5 cm, 5³/₄" **108.123.03**



MAYO
 14,5 cm, 5³/₄" **108.160.14**
 17,0 cm, 6³/₄" **108.160.17**
 23,0 cm, 9" **108.160.23**
 28,0 cm, 11" **108.160.28**



MAYO
 14,5 cm, 5³/₄" **108.161.14**
 17,0 cm, 6³/₄" **108.161.17**
 23,0 cm, 9" **108.161.23**
 28,0 cm, 11" **108.161.28**



MAYO-STILE

15,0 cm, 6"	108.170.15
17,0 cm, 6 ³ / ₄ "	108.170.17
19,5 cm, 7 ³ / ₄ "	108.170.19



MAYO-STILE

15,0 cm, 6"	108.171.15
17,0 cm, 6 ³ / ₄ "	108.171.17
19,5 cm, 7 ³ / ₄ "	108.171.19



108.180.17



108.181.17

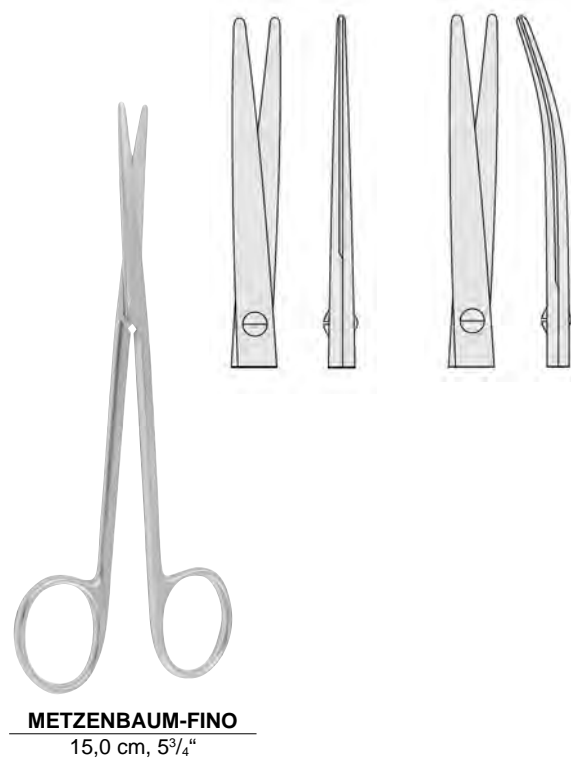
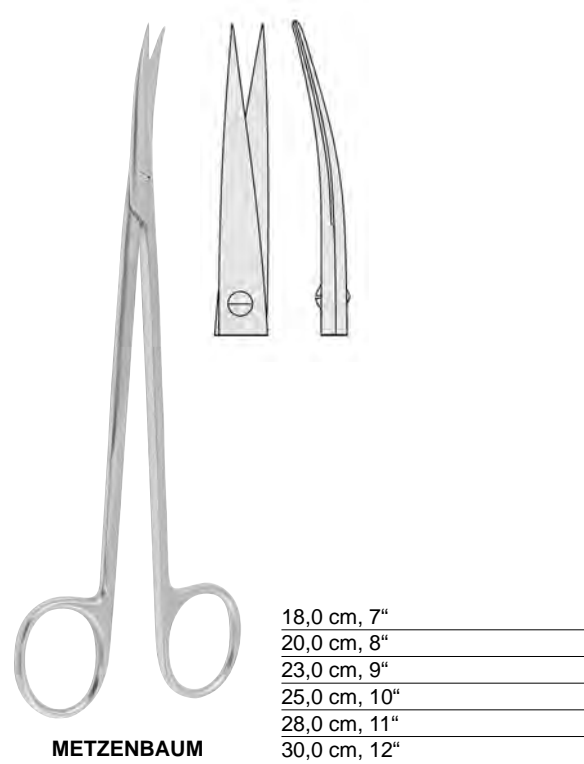
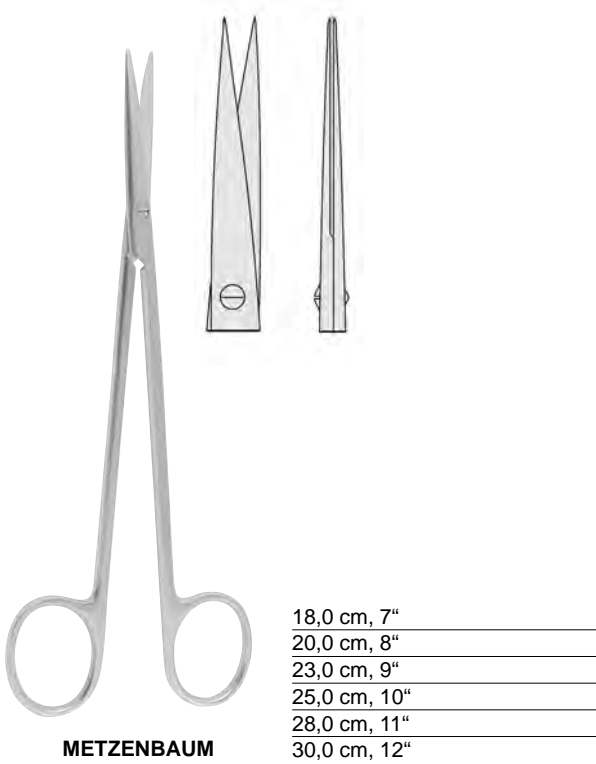
MAYO-NOBLE

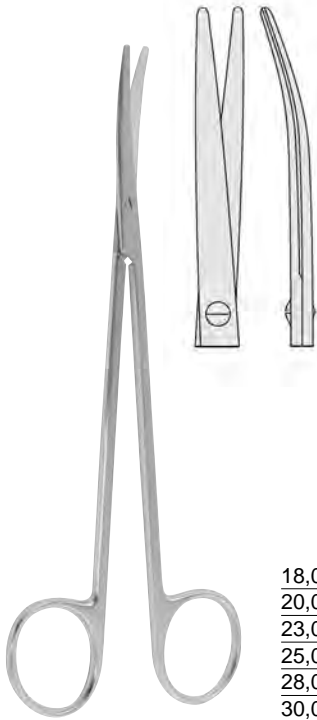
17,0 cm, 6³/₄"



Enukleations Schere

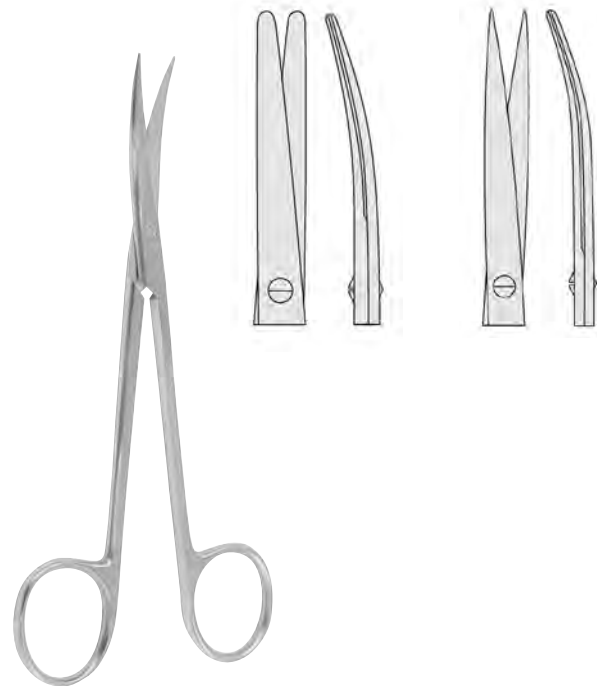
13,0 cm, 5¹/₈" **108.383.13**



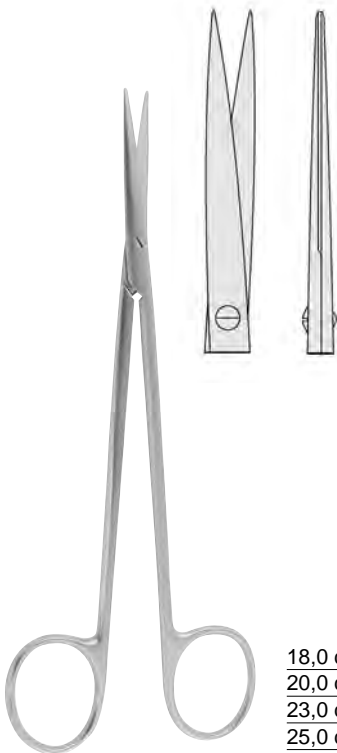


18,0 cm, 7"	108.283.18
20,0 cm, 8"	108.283.20
23,0 cm, 9"	108.283.23
25,0 cm, 10"	108.283.25
28,0 cm, 11"	108.283.28
30,0 cm, 12"	108.283.30

METZENBAUM-FINO

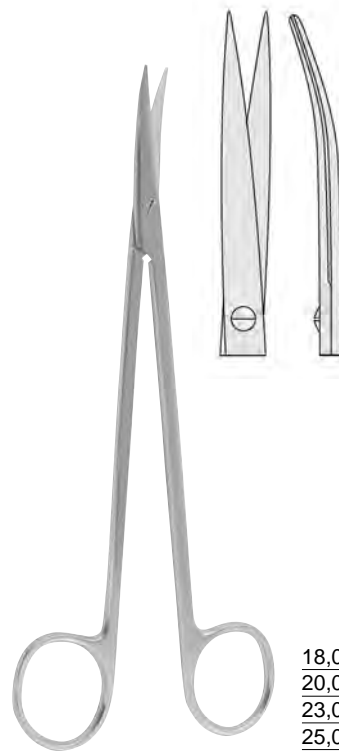


METZENBAUM-FINO
14,5 cm, 5³/₄"



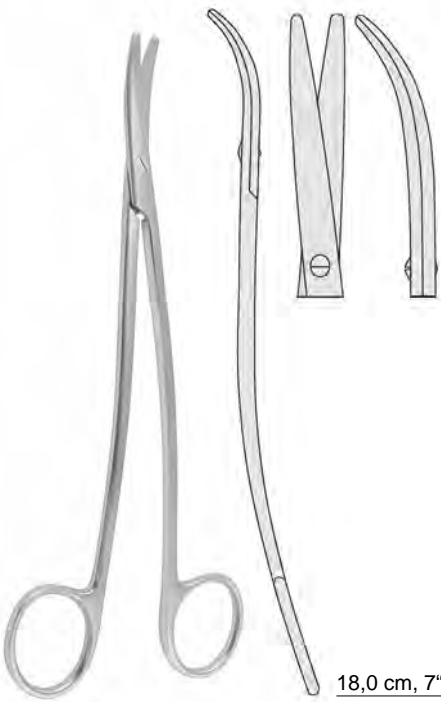
18,0 cm, 7"	_____
20,0 cm, 8"	_____
23,0 cm, 9"	_____
25,0 cm, 10"	_____
28,0 cm, 11"	_____
30,0 cm, 12"	_____

METZENBAUM-FINO



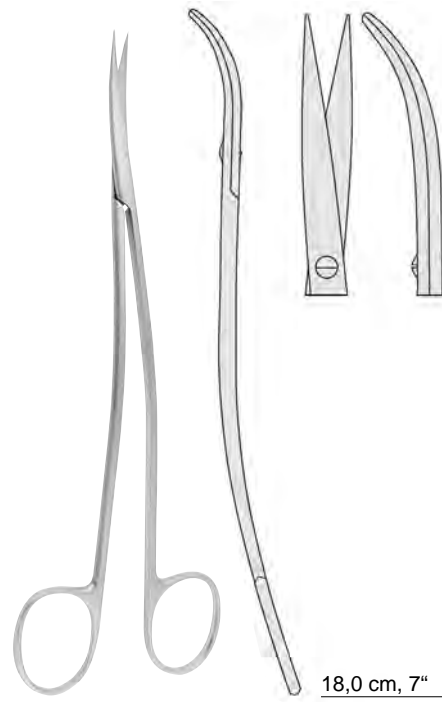
18,0 cm, 7"	_____
20,0 cm, 8"	_____
23,0 cm, 9"	_____
25,0 cm, 10"	_____
28,0 cm, 11"	_____
30,0 cm, 12"	_____

METZENBAUM-FINO



18,0 cm, 7"

108.291.18



18,0 cm, 7"

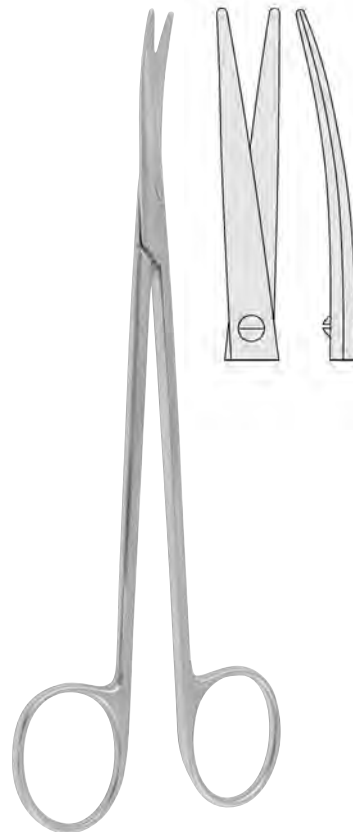
108.293.18

METZENBAUM-FINO S



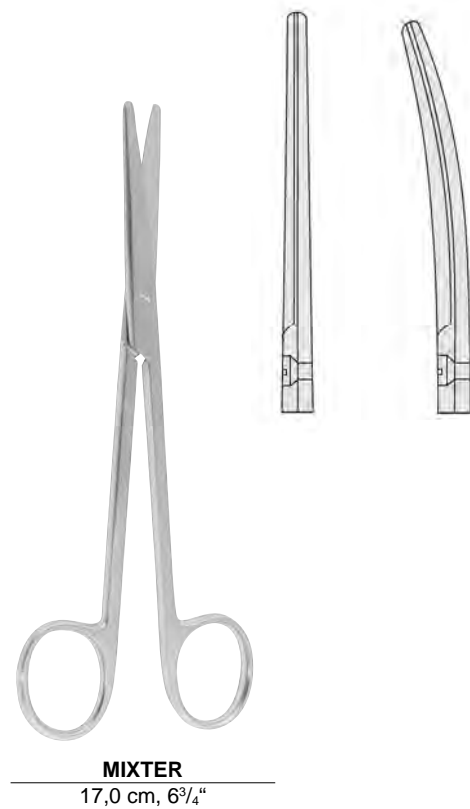
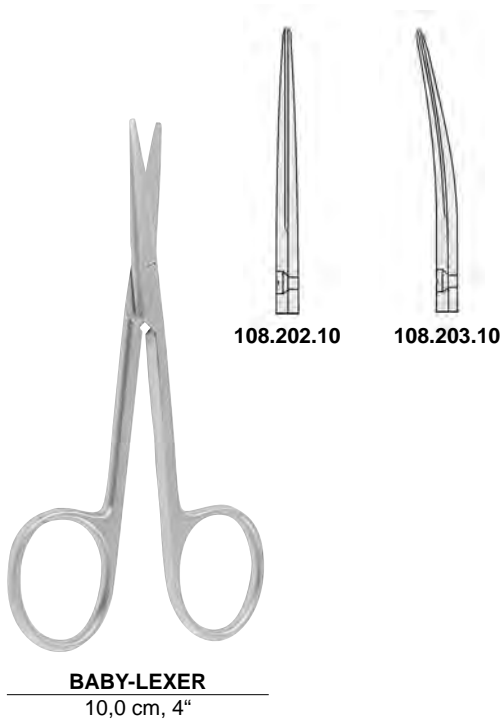
METZENBAUM-LAHEY

14,0 cm, 5½"



TOENNIS-ADSON

17,0 cm, 6¾"

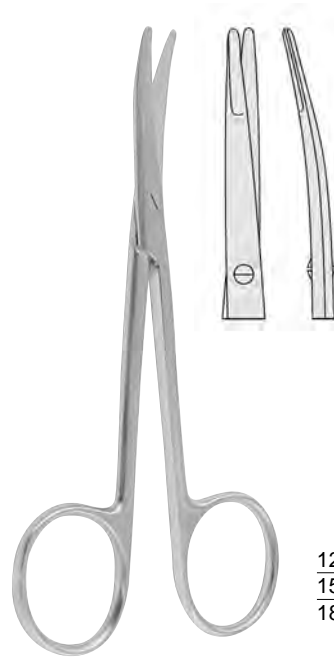


Präparierscheren, feine chirurgische Scheren
 Dissecting Scissors, fine surgical scissors
 Tijeras de disección, tijeras finas para cirugía
 Forbici per dissezione, forbici fine per chirurgia



12,0 cm, 4³/₄" **108.308.12**

KILNER (RAGNELL)



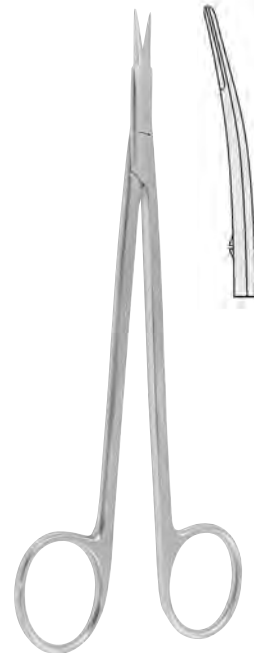
12,0 cm, 4³/₄" **108.310.12**
 15,0 cm, 6" **108.310.15**
 18,0 cm, 7" **108.310.18**

KILNER (RAGNELL)



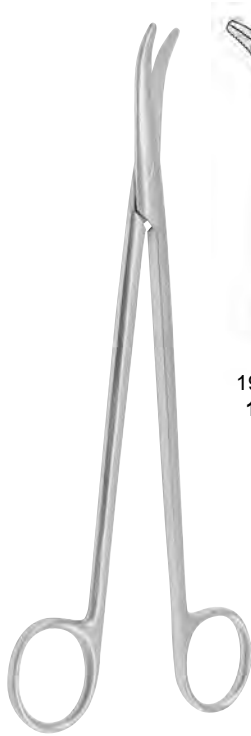
15,0 cm, 6" **108.320.15**
 18,0 cm, 7" **108.320.18**

REYNOLDS



15,0 cm, 6" **108.321.15**
 18,0 cm, 7" **108.321.18**
 20,0 cm, 8" **108.321.20**

REYNOLDS



19,0 cm, 7½"
108.643.18



25,0 cm, 10"
108.643.25

THOREK



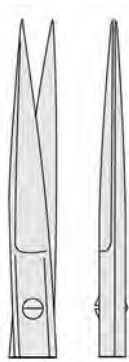
108.582.15



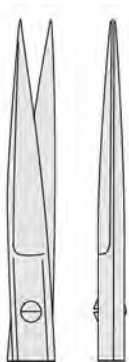
108.583.15

Nerv-Präparierscheren
Nerve dissecting scissors
Tijeras para nervios
Forbici per dissezione di nervi

15,0 cm, 6"

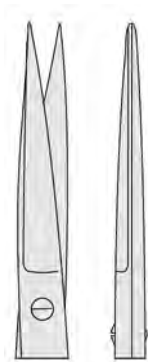


108.302.14

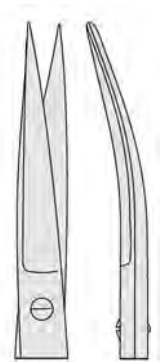


108.303.14

SANVENERO
14,0 cm, 5½"



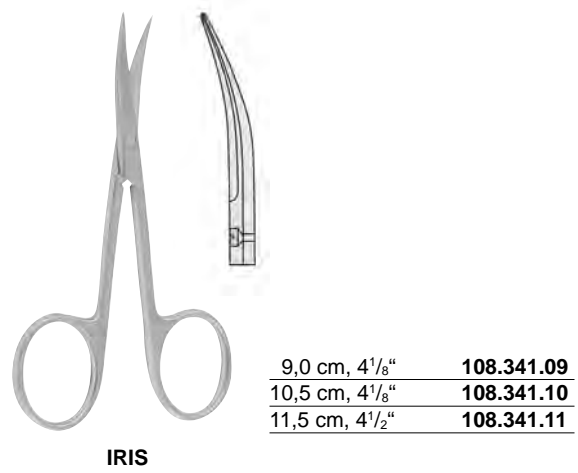
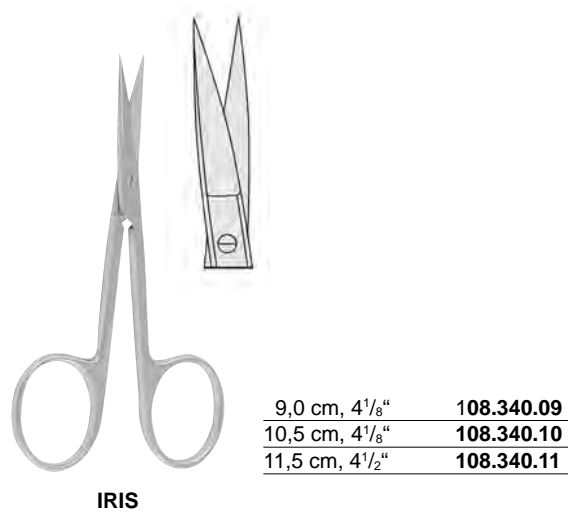
108.304.14



108.305.14

JOSEPH
14,0 cm, 5½"

Feine chirurgische Scheren
 Fine surgical scissors
 Tijeras finas para cirugía
 Forbici fine per chirurgia





11,5 cm, 4 1/2"
108.353.11

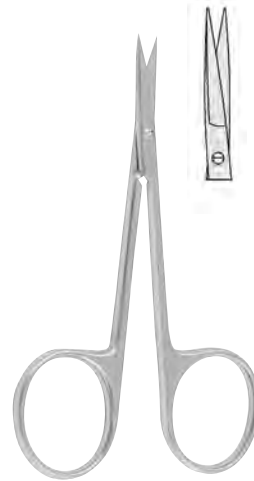


11,5 cm, 4 1/2"
108.351.11

Feine chirurgische Scheren
Fine surgical scissors
Tijeras finas para cirugía
Forbici fine per chirurgia



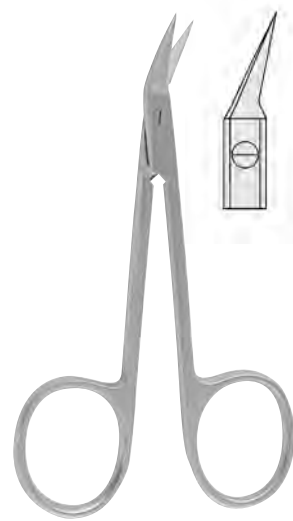
12,0 cm, 4³/₄"



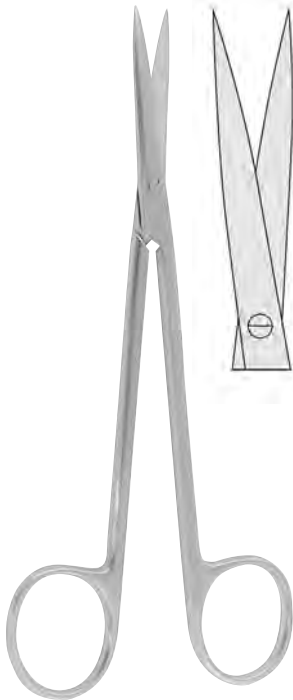
MOD. BONN
8,0 cm, 3¹/₄"
108.352.08



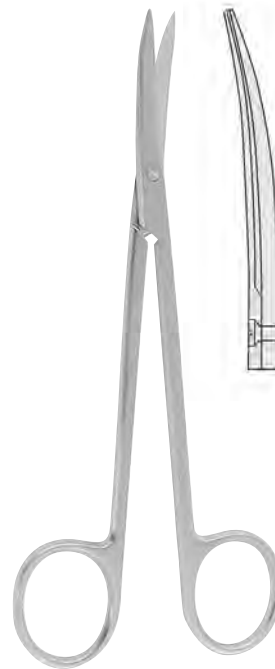
MOD. BONN
8,0 cm, 3¹/₄"
108.353.08



MOD. BONN
8,0 cm, 3¹/₄"



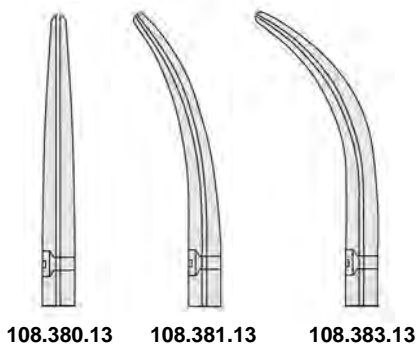
BROPHY (SULLIVAN)
14,0 cm, 5½"



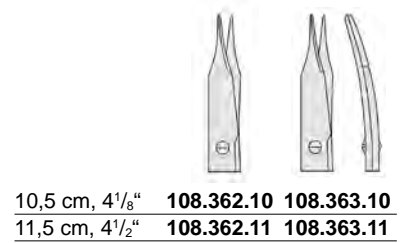
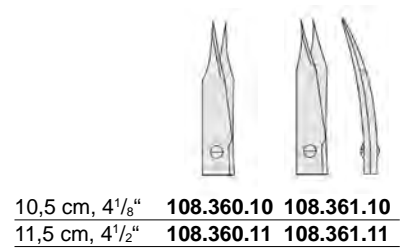
BROPHY (SULLIVAN)
14,5 cm, 5½"
108.815.14



LANDOLT
13,0 cm, 5"



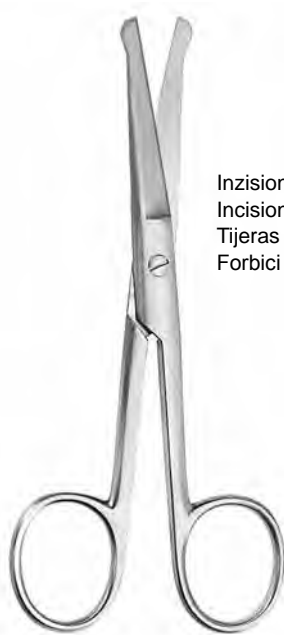
STEVENS





Inzisionsscheren
 Incision scissors
 Tijeras para incisión
 Forbici vascolare e per fistole

13,0 cm, 5" **108.128.13**
 14,0 cm, 5³/₄" **108.128.14**



Inzisionsscheren
 Incision scissors
 Tijeras para incisión
 Forbici vascolare e per fistole

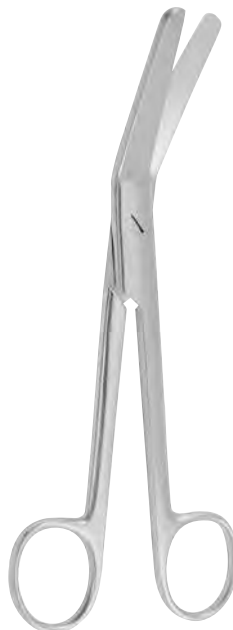
16,5 cm, 36¹/₂"



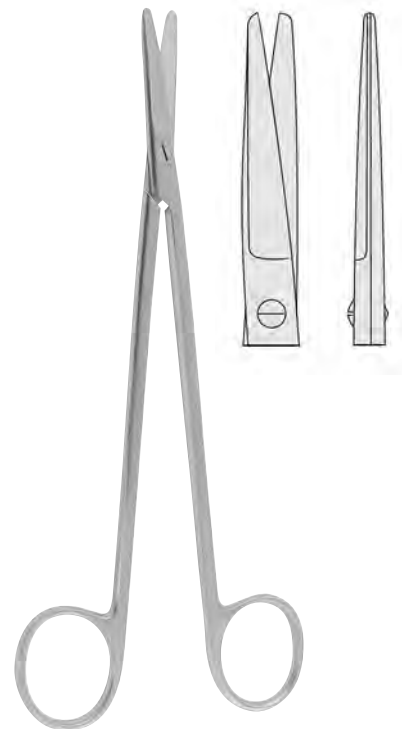
RICHTER
 14,5 cm, 5³/₄"
108.007.14



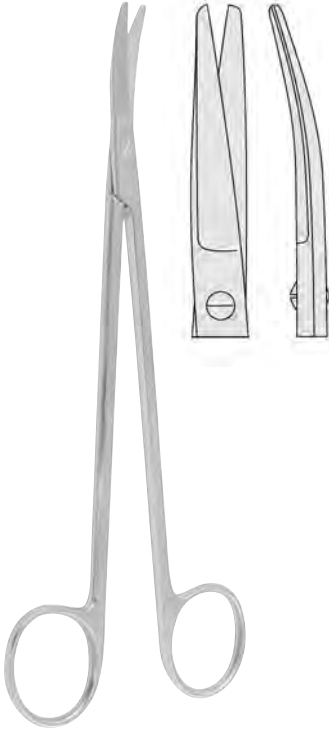
LAWSON TAIT
 12,5 cm, 5"



FERGUSSON
 16,5 cm, 6¹/₄" **108.942.16**
 18,0 cm, 7" **108.942.18**



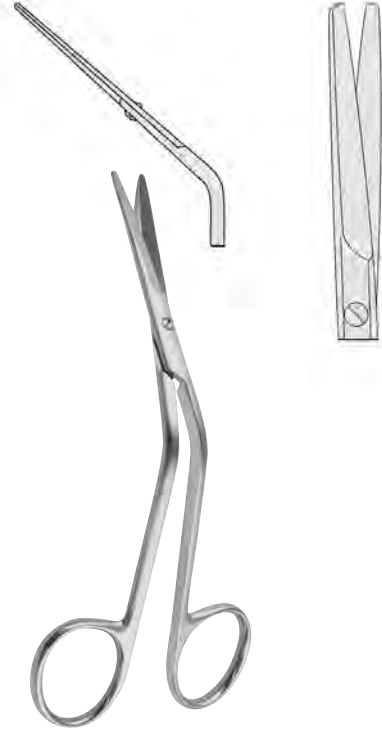
TOENNIS
 18,0 cm, 7"
108.610.18



TOENNIS
18,0 cm, 7"
108.611.18



HALLE
19,0 cm, 7½"



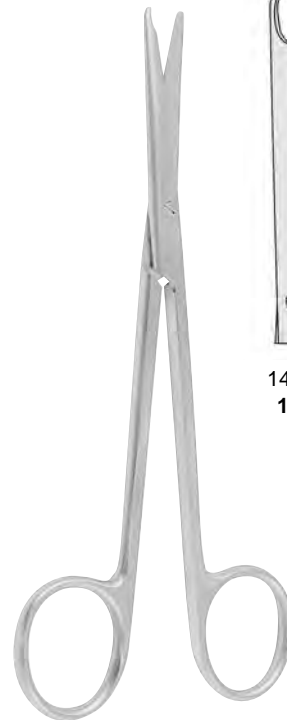
FOMON
15,0 cm, 6"
108.403.15



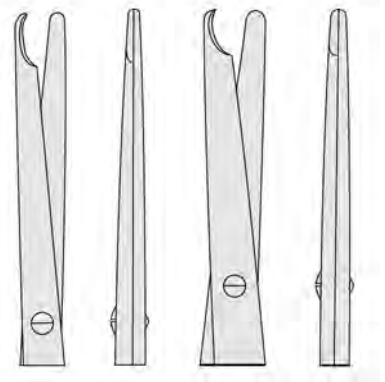
SPENCER
9,0 cm, 4⅛" **108.802.09**
10,5 cm, 4⅛" **108.802.11**
13,0 cm, 5" **108.802.12**



LITTAUER
14,0 cm, 5½" **108.804.14**

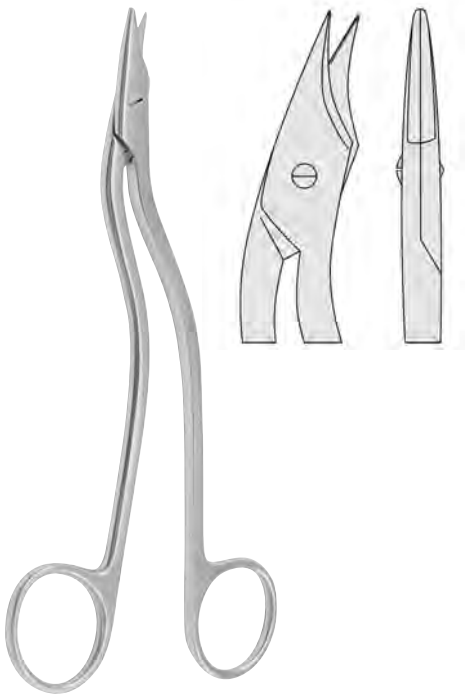


BUCK



14,5 cm, 5¾" **108.806.14**

18,0 cm, 7" **108.806.18**



HEATH
 15,0 cm, 6¹/₄"
 108.809.15



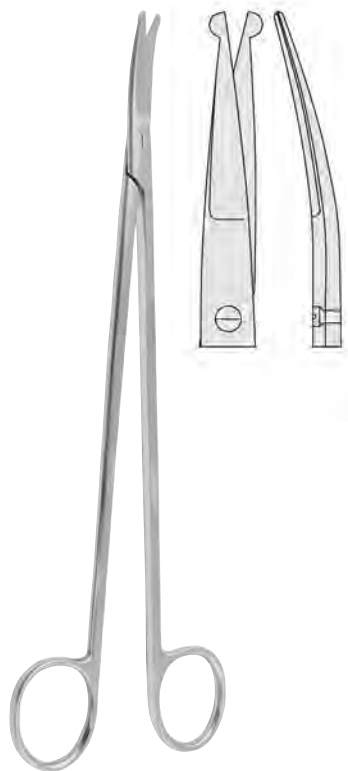
SHORTBENT
 9,0 cm, 3¹/₂"
 108.803.09



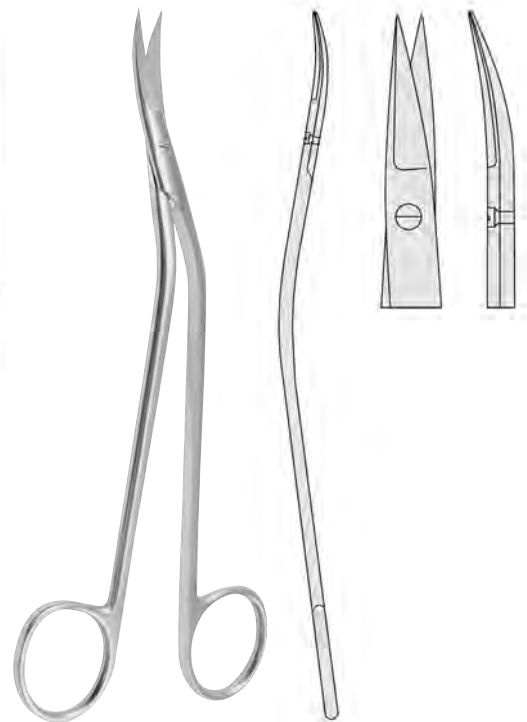
NORTHBENT
 13,0 cm, 5"
 108.803.13



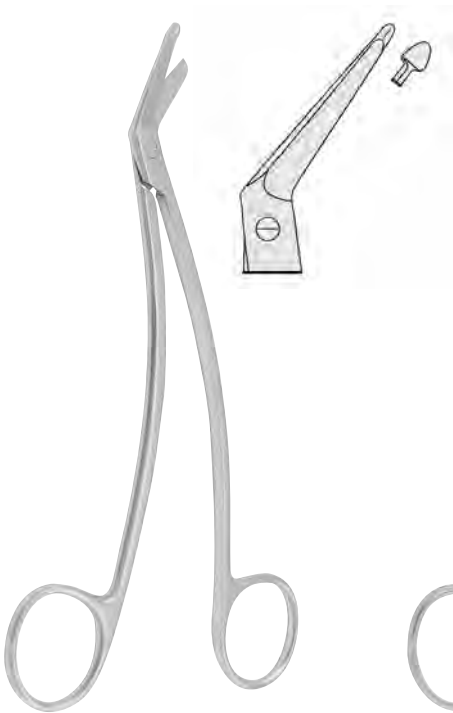
EISELSBERG
 12,0 cm, 4³/₄"
 108.810.12



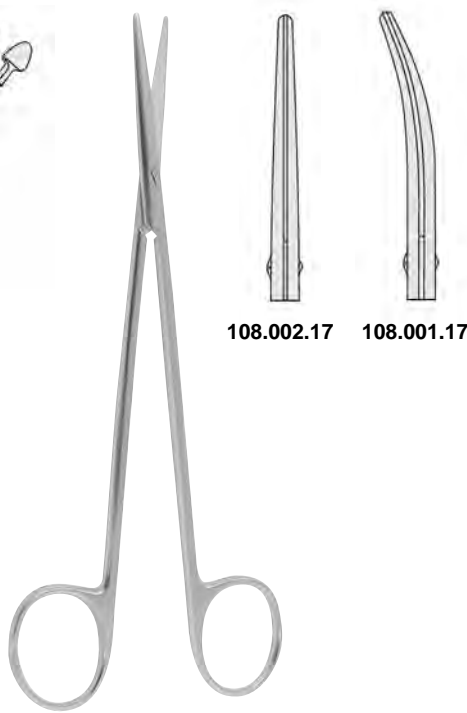
STRULLY
 22,0 cm, 8⁵/₈"
 108.601.22



DANDY
 17,0 cm, 6³/₄"
 108.617.17



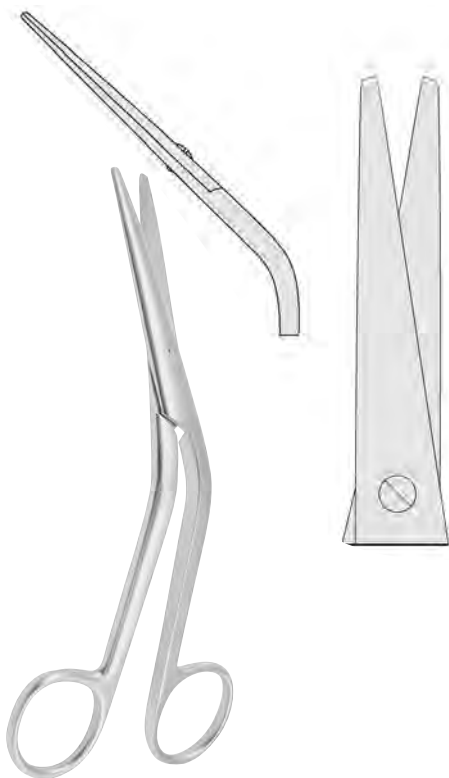
SCHMIEDEN-TAYLOR
17,0 cm, 6³/₄"
108.619.17



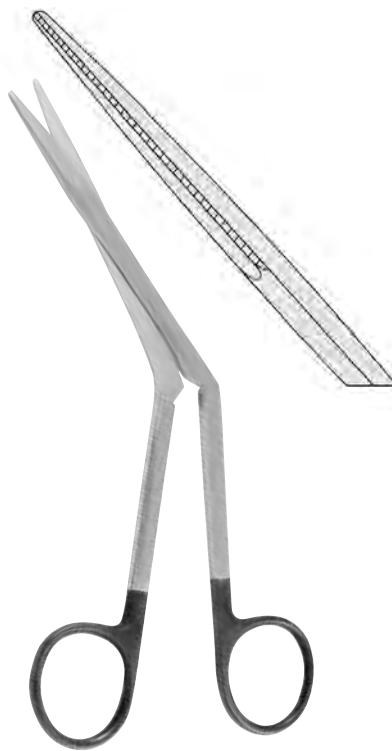
LINCOLN
17,0 cm, 6³/₄"



HEYMANN
18,0 cm, 7"
108.401.18



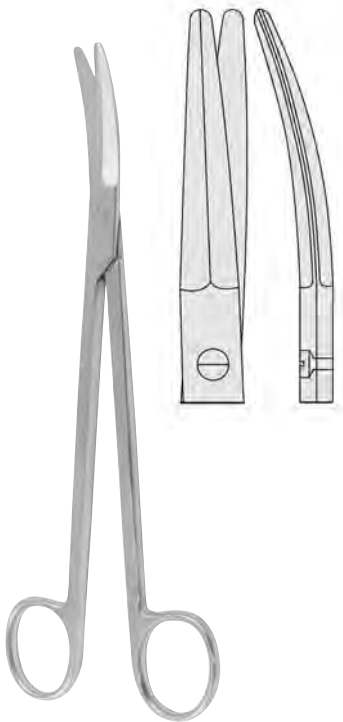
COTTLE
16,0 cm, 6¹/₄"
108.405.16



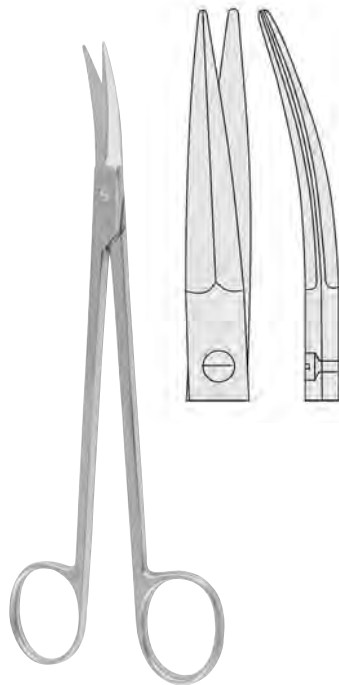
KIRSTEN
18,0 cm, 7"



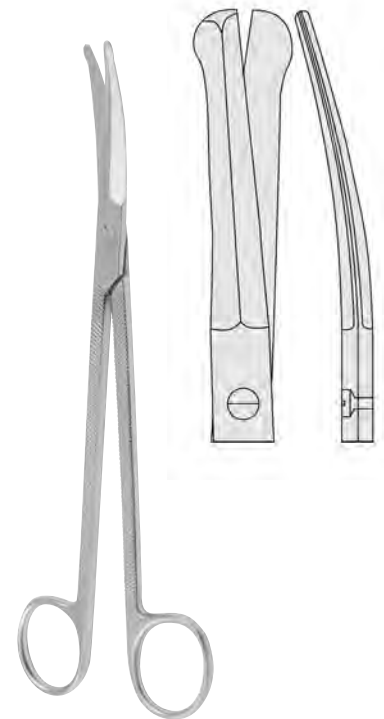
CAPLAN
20,0 cm, 8⁵/₈"
146.247.20



BOETTCHER
 18,0 cm, 7"
 108.435.18



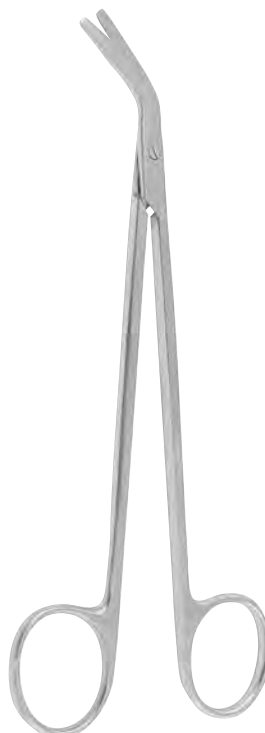
PRINCE
 17,5 cm, 6⁵/₈"
 108.439.17



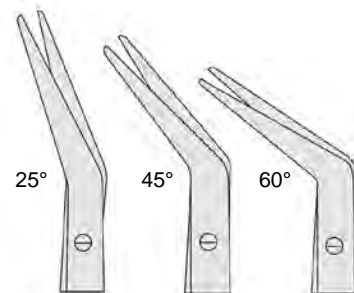
GOOD
 19,0 cm, 7¹/₂"
 108.437.19



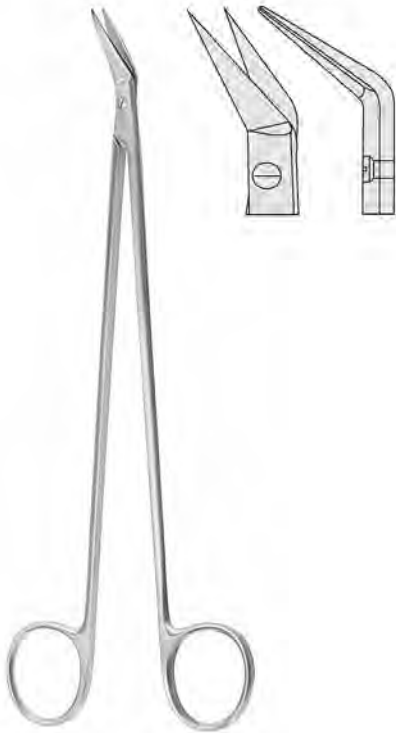
CARTILAGE
 20,0 cm, 8"
 108.840.20



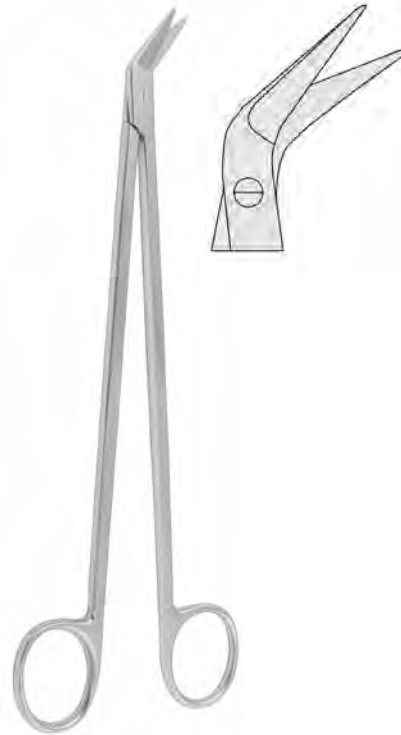
DE BAKEY



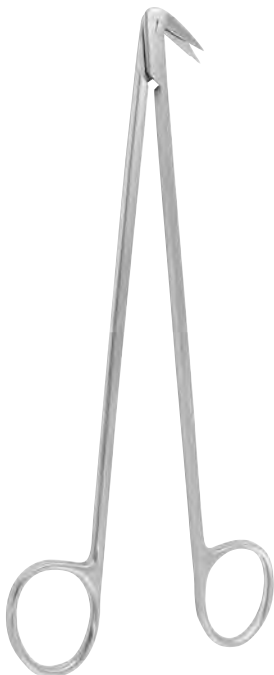
16,0 cm, 6 ⁵ / ₈ "	108.490.16	108.491.16	108.492.16
19,5 cm, 7 ³ / ₄ "	108.490.19	108.491.19	108.492.19
23,0 cm, 9"	108.490.23	108.491.23	108.492.23
28,0 cm, 11"	108.490.28	108.491.28	108.492.28



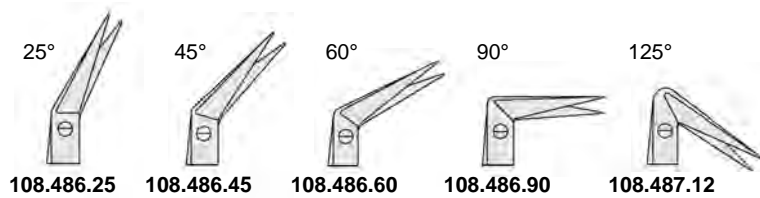
POTTS-SMITH
18,0 cm, 7"

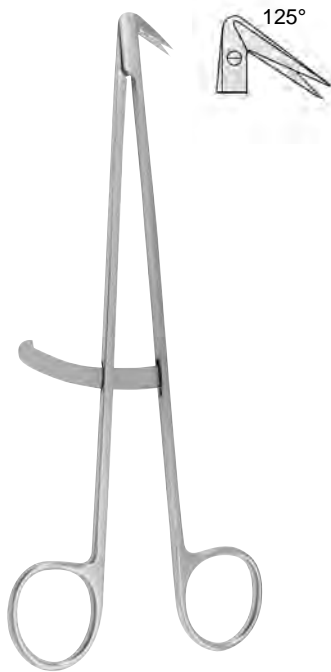


POTTS DE MARTEL
21,0 cm, 8 1/4" **108.473.21**
24,0 cm, 9 1/2" **108.473.24**

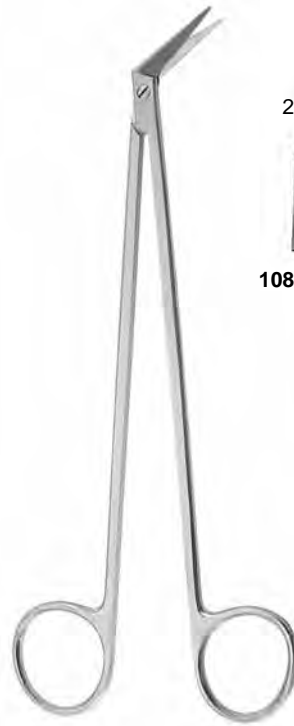


DIETRICH-HEGEMANN
18,0 cm, 7 1/2"

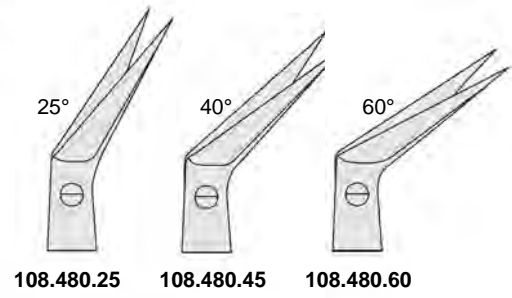




DIETRICH
 18,0 cm, 7 1/2"
 108.488.25



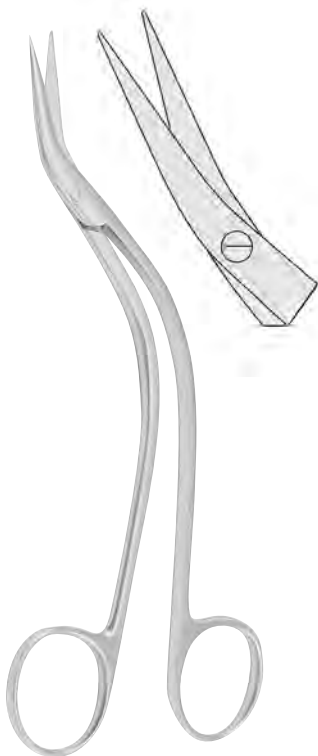
POTTS-SMITH
 19,0 cm, 7 1/2"



108.480.25

108.480.45

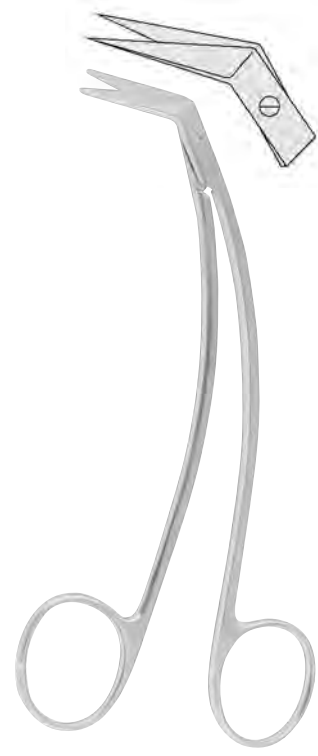
108.480.60



DE BAKEY
 15,5 cm, 6"
 108.495.15



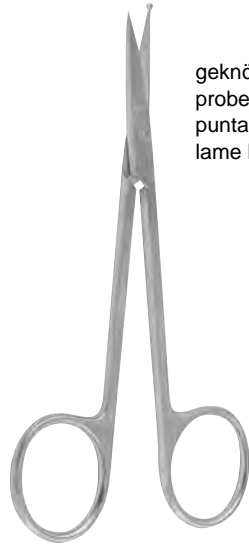
DE BAKEY
 15,5 cm, 6"
 108.497.15



FAVOLORO
 15,5 cm, 6"
 108.498.15



MC INDOE
19,0 cm, 7½"
108.614.19



geknöpftes Blatt
probe-pointed blade
punta botonda
lame bottonuta

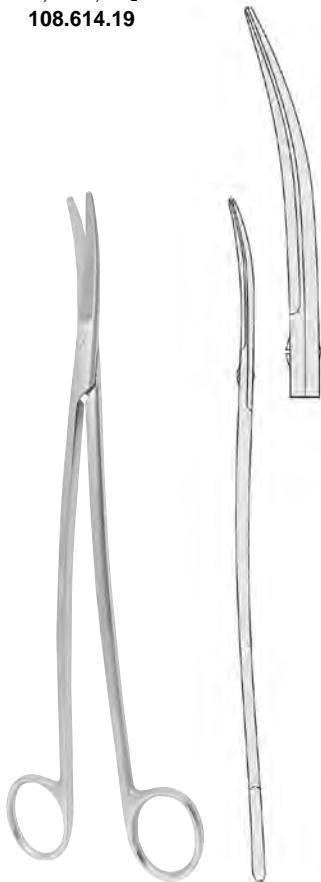
11,5 cm, 4½"
108.470.11



CRAFOORD
30,0 cm, 12"
108.641.30



SATINSKY
15,5 cm, 9⅝"
108.651.24



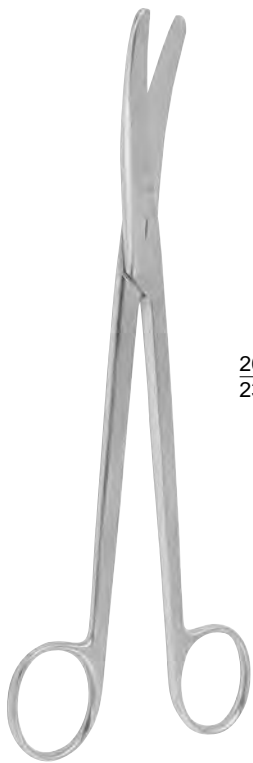
KLINGENBERG-LOTH
23,0 cm, 9"
108.661.23



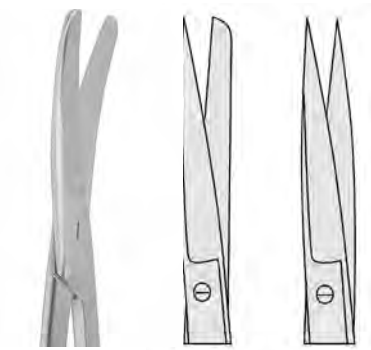
SIMS



20,0 cm, 8"	108.510.20	108.512.20	108.518.20
23,0 cm, 9"	108.510.23	108.512.23	108.518.23



SIMS



20,0 cm, 8"	108.511.20	108.513.20	108.517.20
23,0 cm, 9"	108.513.23	108.513.23	108.517.23



SIEBOLD
 24,0 cm, 9½"
108.523.24



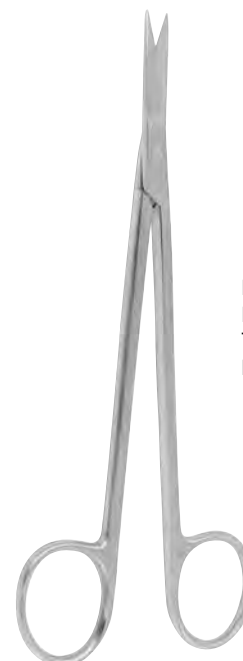
BOZEMANN
 22,0 cm, 8¾"



DOYEN

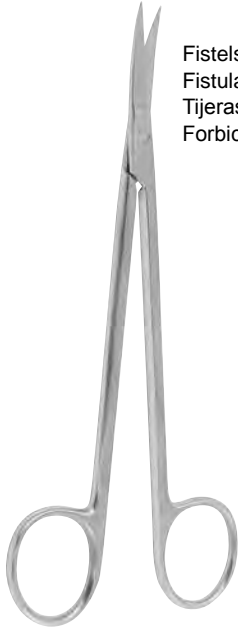


16,0 cm, 6¼"		108.532.16
17,5 cm, 6⅝"	108.530.17	108.531.17



KELLY
 16,0 cm, 6¼" **108.540.16**
 18,0 cm, 7" **108.540.18**

Fistelscheren
 Fistula scissors
 Tijeras para fistulas
 Forbici per fistole



Fistelscheren
Fistula scissors
Tijeras para fistulas
Forbici per fistole

KELLY

16,0 cm, 6¹/₄" **108.541.16**
18,0 cm, 7" **108.541.18**



WERTHEIM

19,5 cm, 7³/₄" **108.525.19**
22,5 cm, 8³/₄" **108.525.22**



108.537.27

DUBOIS

27,0 cm, 10⁵/₈" **108.536.27**



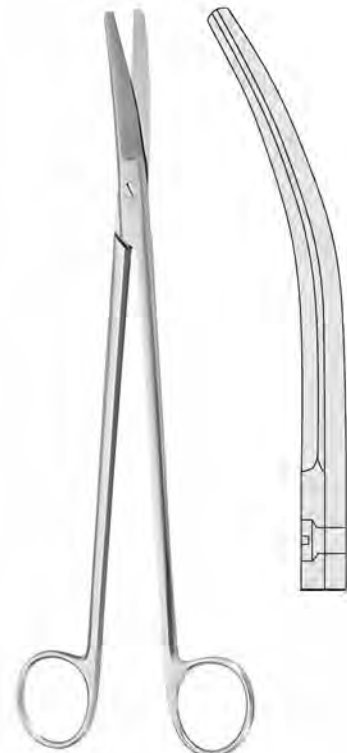
21,0 cm, 8¹/₄" **108.770.21**



21,0 cm, 8¹/₄" **108.772.21**

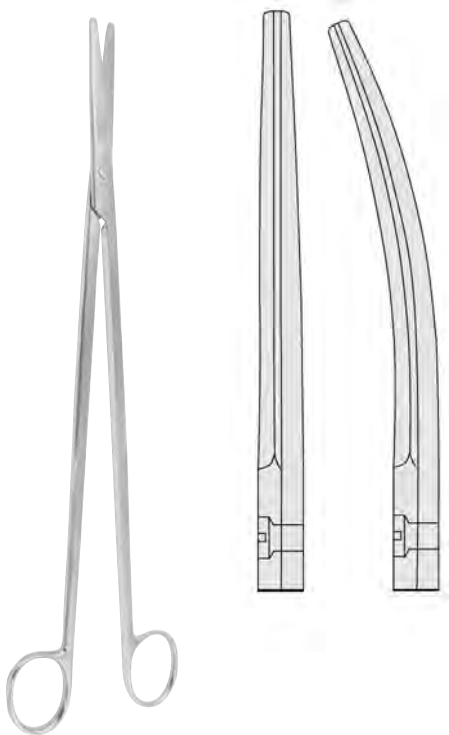


21,0 cm, 8¹/₄" **108.774.21**

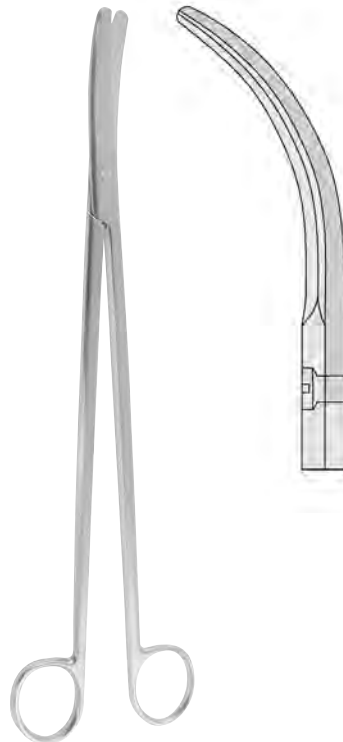


LLOYD-DAVIES
27,0 cm, 10⁵/₈"

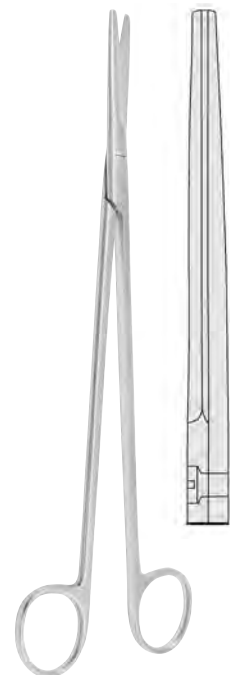
Lungenlappen- und Rektumscheren, Lungenscheren, Dammscheren
 Lobectomy and Rectal Scissors, Lobectomy Scissors, Episiotomy Scissors
 Tijeras para lobectomía y recto, Tijera para lobectomía, Tijeras para episiotomía
 Forbici per lobo polmonare e per il retto, Forbici per lobo, Forbici per episiotomia



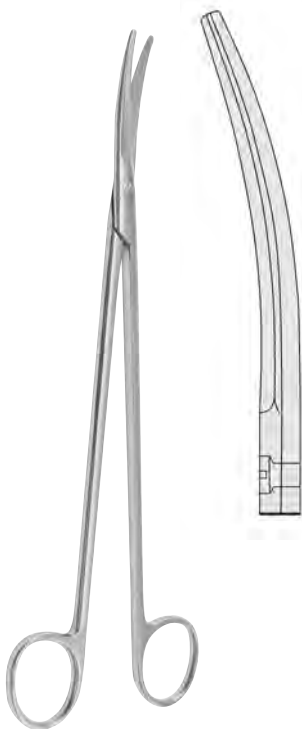
STELZNER
 31,0 cm, 12¹/₄"



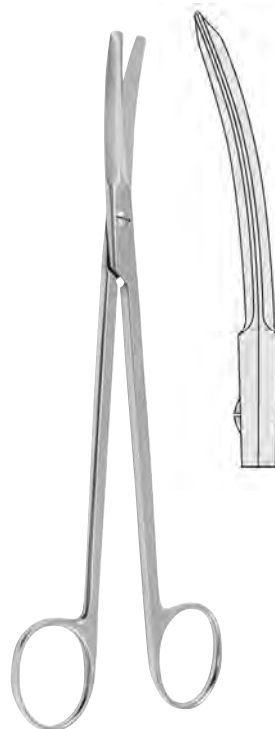
RECTAL
 32,5 cm, 12³/₄"



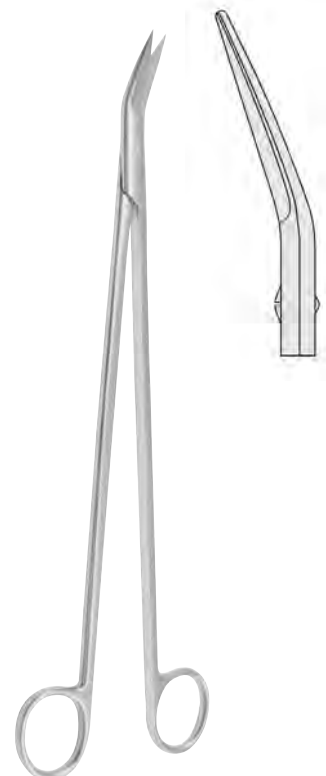
WILLAUER
 25,0 cm, 9³/₄"
 28,0 cm, 11"



WILLAUER
 25,0 cm, 9³/₄"
 28,0 cm, 11"



POTTS-SMITH
 19,0 cm, 7¹/₂"
 108.467.19



FINOCHIETTO
 32,5 cm, 10⁵/₈"
 108.663.27



WALDMANN
18,0 cm, 7"
108.555.18



BRAUN-STADLER
14,5 cm, 5³/₄" **108.560.14**
20,0 cm, 8" **108.560.20**
22,0 cm **108.560.22**



24,0 cm, 8"
108.561.24



MOD. USA
10,5 cm, 4¹/₈"
108.550.10



BUSCH
16,0 cm, 6¹/₄" **108.551.16**



SCHUMACHER
16,0 cm, 16¹/₄"
108.553.16



gezahnt
 serrated
 dentada
 dentata

UNIVERSAL
 12,0 cm, 4³/₄"
 108.831.12



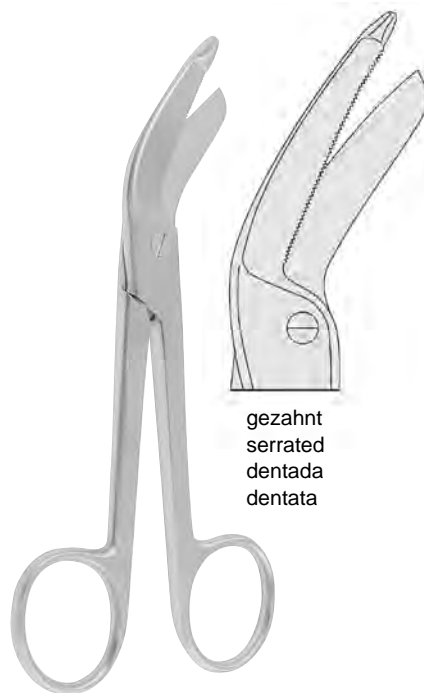
LISTER

9,0 cm, 3 ¹ / ₂ "	108.901.09
11,0 cm, 4 ³ / ₈ "	108.901.11
14,0 cm, 5 ¹ / ₂ "	108.901.14
18,0 cm, 7"	108.901.18
20,0 cm, 8"	108.901.20



LISTER

21,0 cm, 8¹/₄" **108.901.21**



gezahnt
 serrated
 dentada
 dentata

LISTER-EXCENTRIC

16,0 cm, 6¹/₄" **108.921.16**
 19,0 cm, 7¹/₂" **108.921.19**



BERGMANN

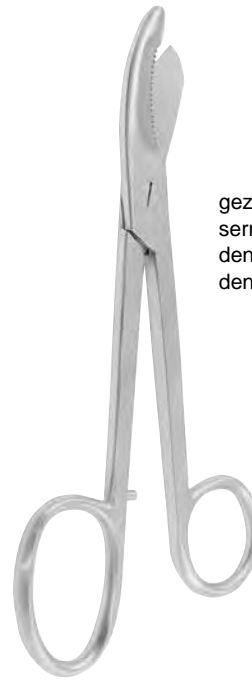
23,0 cm, 9"
108.911.23



ESMARCH
20,0 cm, 8" **108.913.20**
22,0 cm, 8⁵/₈" **108.913.22**

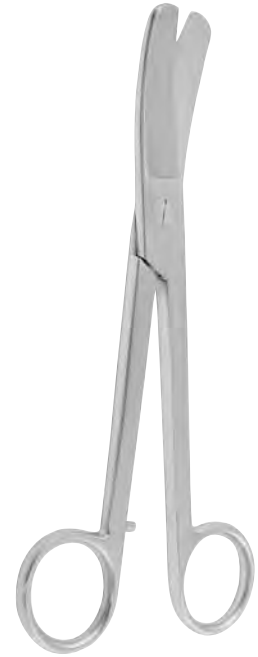


KNOWLES
14,0 cm, 5¹/₂"
108.930.14



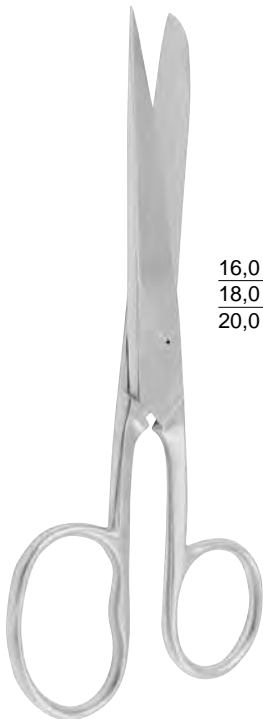
BRUNS
24,0 cm, 9¹/₂"
glatt **108.935.23**
gezahnt **108.937.23**

gezahnt
serrated
dentada
dentata



LORENZ
23,0 cm, 9"
108.933.23

bis 134°C autoklavierbar
autoclavable up to 134°C
esterilizable en autoclave hasta 134°C
Sterilizzabile in autoclave fino 134°C



SMITH
(MOD. USA)

16,0 cm, 6¹/₄" **108.898.16**
18,0 cm, 7" **108.898.18**
20,0 cm, 8" **108.898.20**



gezahnt
serrated
dentada
dentata

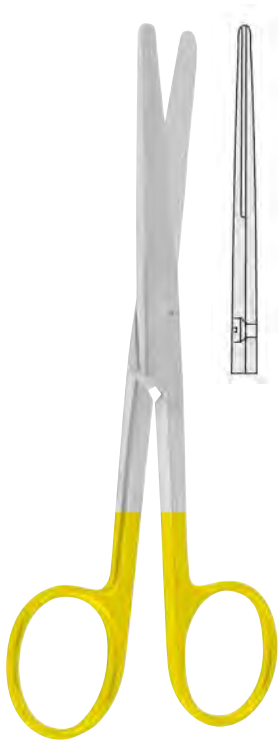
20,0 cm, 8"
108.941.20



gezahnt
serrated
dentada
dentata

UNIVERSAL
15,0 cm, 5¹/₂" **108.950.15**
18,0 cm, 7" **108.950.18**

Chirurgische Scheren mit Hartmetallschneiden
 Surgical Scissors with tungsten carbide edges
 Tijeras para cirugía con filos de carburo tungsteno
 Forbici per chirurgia con lame in carburo di tungsteno



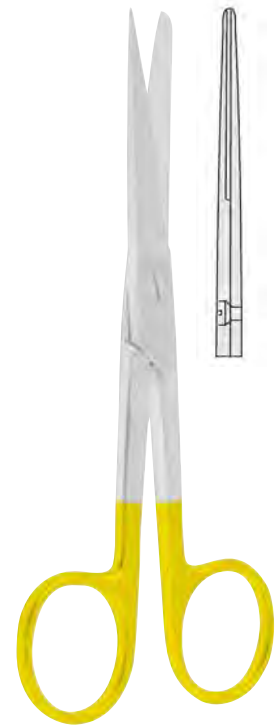
STANDARD

14,5 cm, 5 ³ / ₄ "	108.104.14
16,5 cm, 6 ¹ / ₂ "	108.104.16
18,5 cm, 7 ¹ / ₄ "	108.104.18



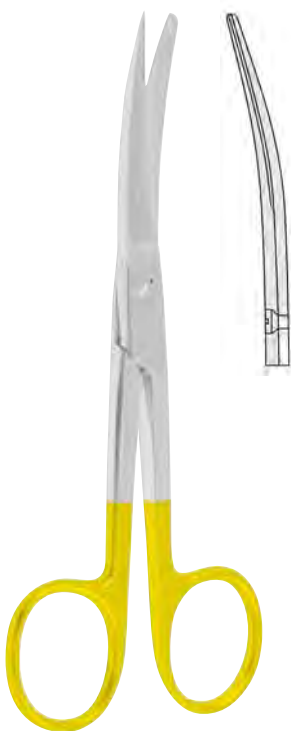
STANDARD

14,5 cm, 5 ³ / ₄ "	108.105.14
16,5 cm, 6 ¹ / ₂ "	108.105.16
18,5 cm, 7 ¹ / ₄ "	108.105.18



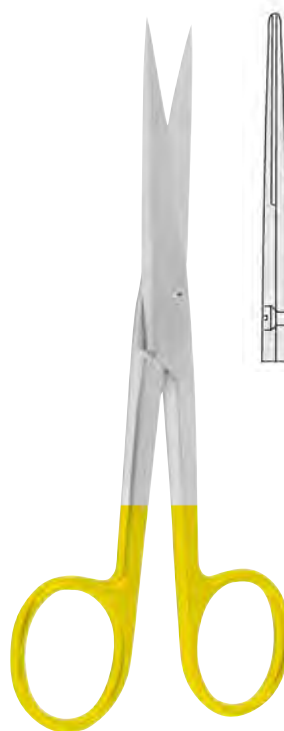
STANDARD

14,5 cm, 5 ³ / ₄ "	108.114.14
16,5 cm, 6 ¹ / ₂ "	108.114.16
18,5 cm, 7 ¹ / ₄ "	108.114.18



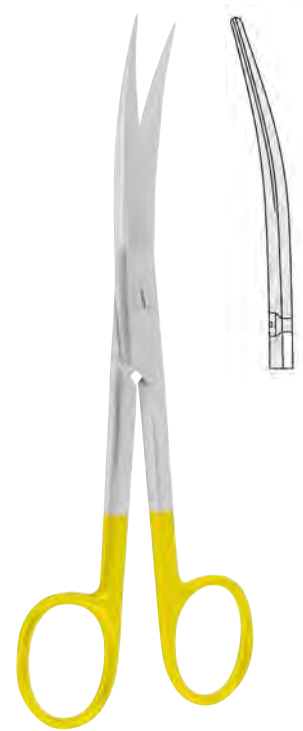
STANDARD

14,5 cm, 5 ³ / ₄ "	108.115.14
16,5 cm, 6 ¹ / ₂ "	108.115.16
18,5 cm, 7 ¹ / ₄ "	108.115.18



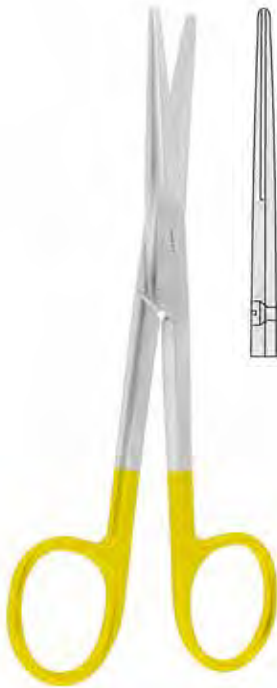
STANDARD

14,5 cm, 5 ³ / ₄ "	108.124.14
16,5 cm, 6 ¹ / ₂ "	108.124.16
18,5 cm, 7 ¹ / ₄ "	108.124.18



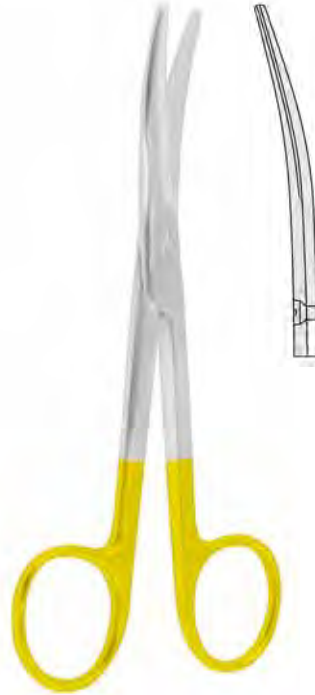
STANDARD

14,5 cm, 5 ³ / ₄ "	108.124.14
16,5 cm, 6 ¹ / ₂ "	108.125.16
18,5 cm, 7 ¹ / ₄ "	108.125.18



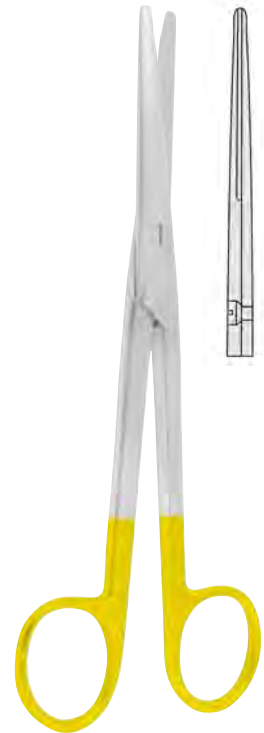
MAYO

14,5 cm, 5 ³ / ₄ "	108.164.14
17,0 cm, 6 ³ / ₄ "	108.164.17
23,0 cm, 9"	108.164.23



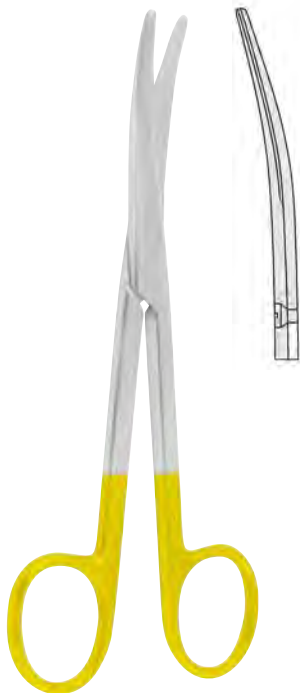
MAYO

14,5 cm, 5 ³ / ₄ "	108.165.14
17,0 cm, 6 ³ / ₄ "	108.165.17
23,0 cm, 9"	108.165.23



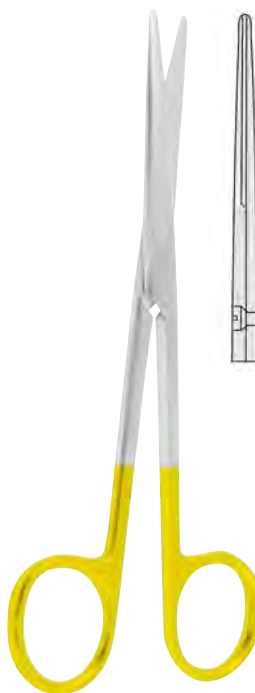
MAYO-STILLE

15,0 cm, 6"	108.174.15
17,0 cm, 6 ³ / ₄ "	108.174.17



MAYO-STILLE

15,0 cm, 6"	108.175.15
17,0 cm, 6 ³ / ₄ "	108.175.17



LEXER

16,0 cm, 6 ¹ / ₄ "	108.194.16
21,0 cm, 8 ¹ / ₄ "	108.194.21



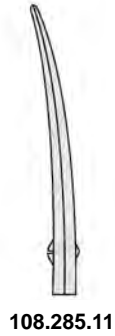
LEXER

16,0 cm, 6 ¹ / ₄ "	108.195.16
21,0 cm, 8 ¹ / ₄ "	108.195.21

Präparierscheren mit Hartmetallschneiden
 Dissecting Scissors with tungsten carbide edges
 Tijeras para disección con filos de carburo tungsteno
 Forbici per dissezione con lame in carburo di tungsteno

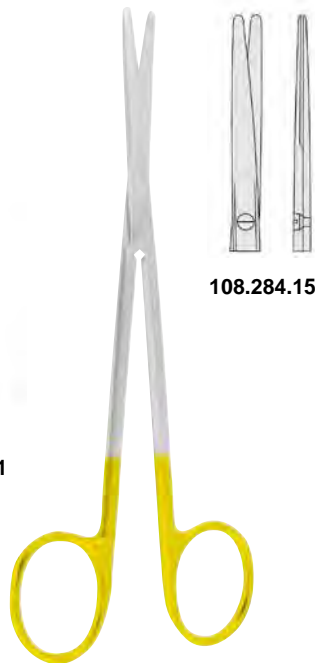


108.284.11



108.285.11

BABY-METZENBAUM
 11,5 cm, 4½"



108.284.15

METZENBAUM
 15,0 cm, 5¾"

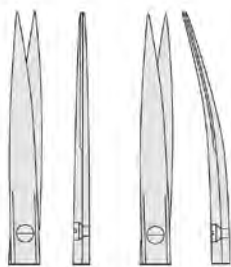


108.285.15

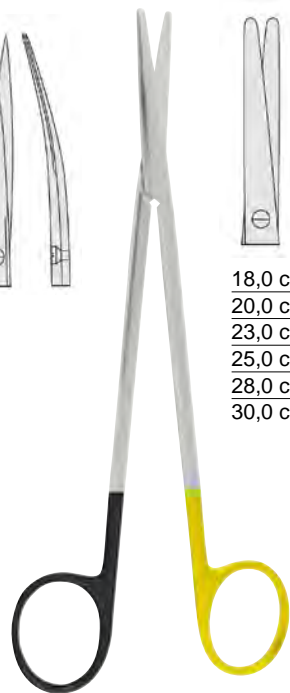
METZENBAUM
 15,0 cm, 5¾"



METZENBAUM
 14,5 cm, 5¾"



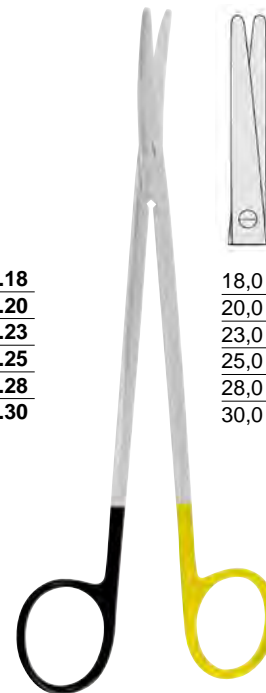
18,0 cm, 7" **107.284.18**
 20,0 cm, 8" **107.284.20**
 23,0 cm, 9" **107.284.23**
 25,0 cm, 10" **107.284.25**
 28,0 cm, 11" **107.284.28**
 30,0 cm, 12" **107.284.30**



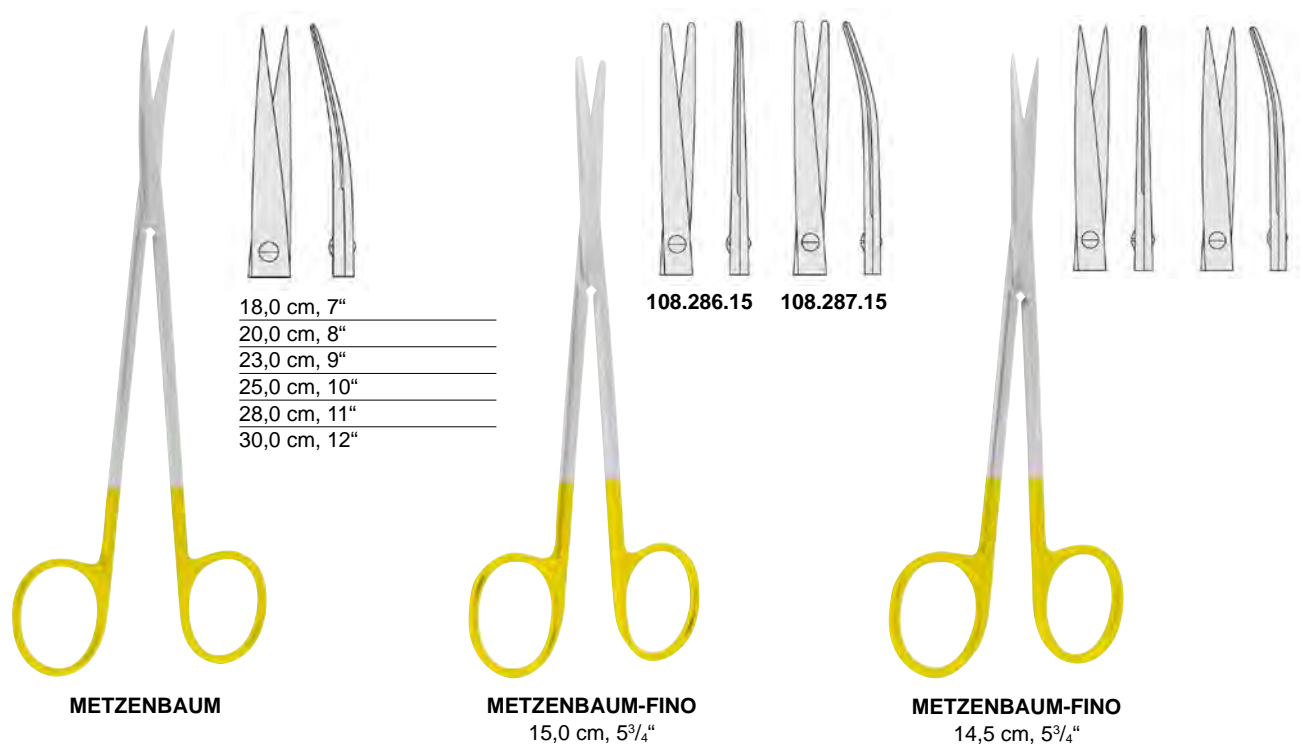
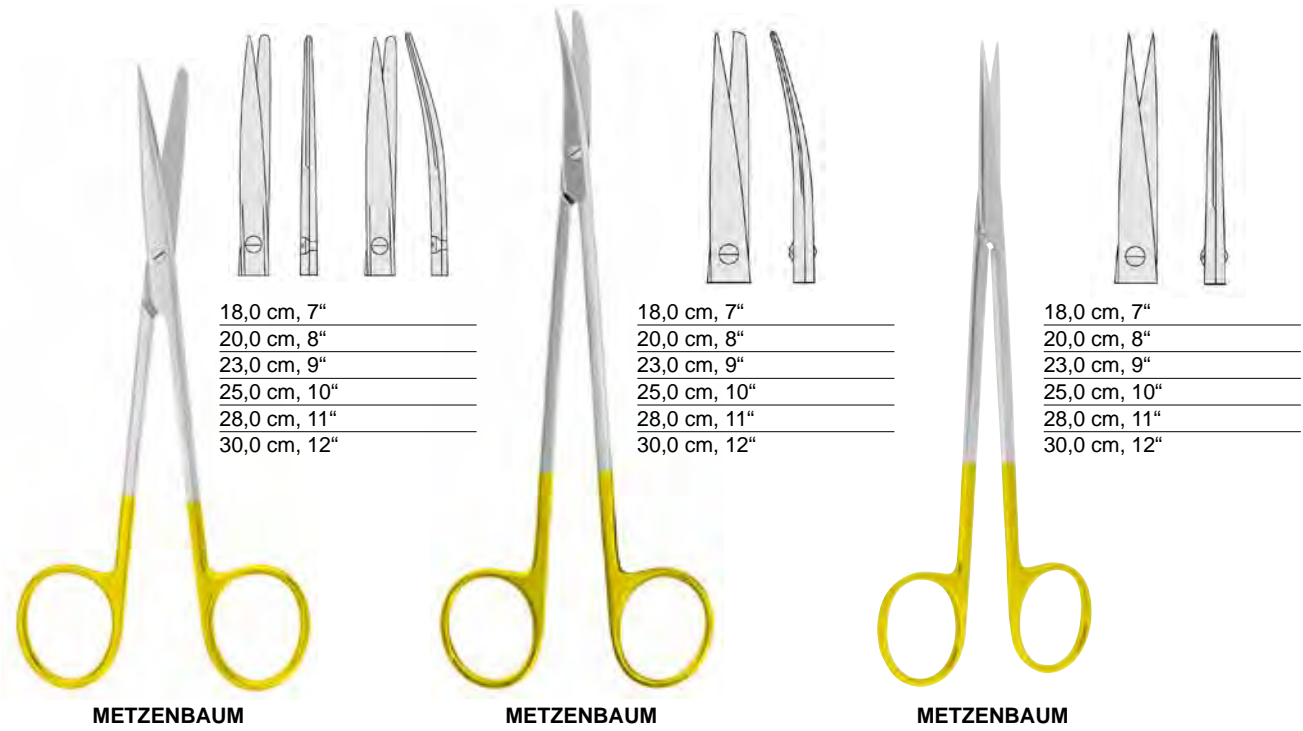
METZENBAUM



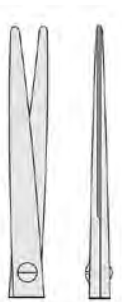
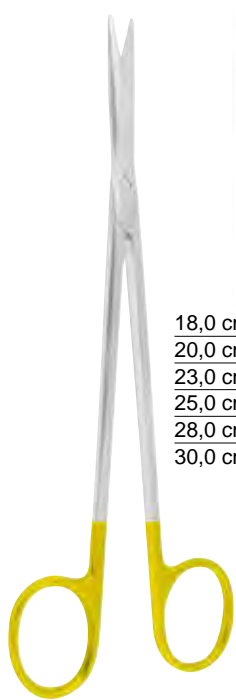
18,0 cm, 7" **107.285.18**
 20,0 cm, 8" **107.285.20**
 23,0 cm, 9" **107.285.23**
 25,0 cm, 10" **107.285.25**
 28,0 cm, 11" **107.285.28**
 30,0 cm, 12" **107.285.30**



METZENBAUM

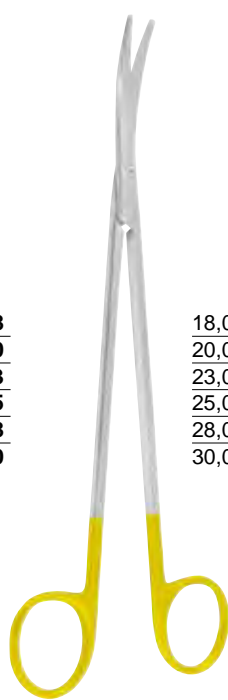


Präparierscheren mit Hartmetallschneiden
 Dissecting Scissors with tungsten carbide edges
 Tijeras para disección con filos de carburo tungsteno
 Forbici per dissezione con lame in carburo di tungsteno



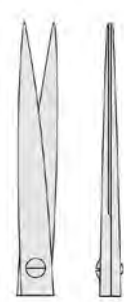
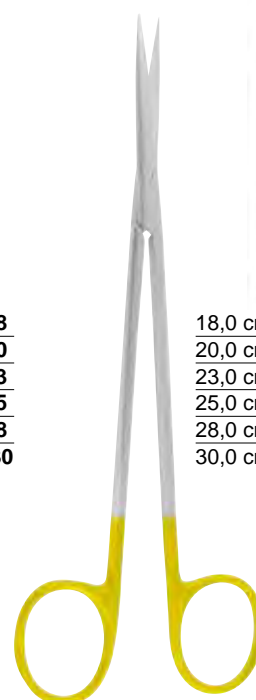
18,0 cm, 7"	108.286.18
20,0 cm, 8"	108.286.20
23,0 cm, 9"	108.286.23
25,0 cm, 10"	108.286.25
28,0 cm, 11"	108.286.28
30,0 cm, 12"	108.286.30

METZENBAUM-FINO



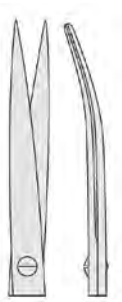
18,0 cm, 7"	108.287.18
20,0 cm, 8"	108.287.20
23,0 cm, 9"	108.287.23
25,0 cm, 10"	108.287.25
28,0 cm, 11"	108.287.28
30,0 cm, 12"	108.287.30

METZENBAUM-FINO



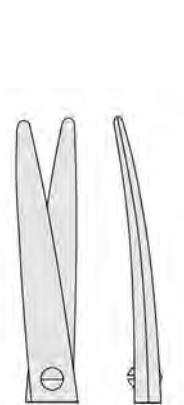
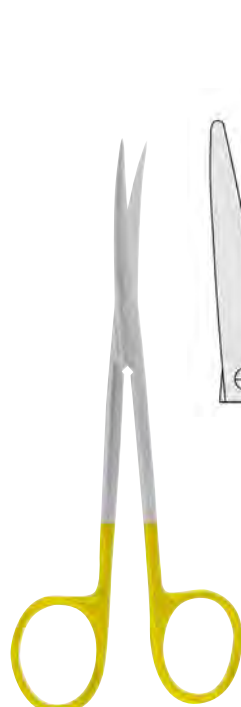
18,0 cm, 7"	108.296.18
20,0 cm, 8"	108.296.20
23,0 cm, 9"	108.296.23
25,0 cm, 10"	108.296.25
28,0 cm, 11"	108.296.28
30,0 cm, 12"	108.296.30

METZENBAUM-FINO

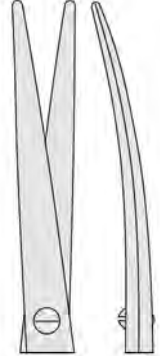
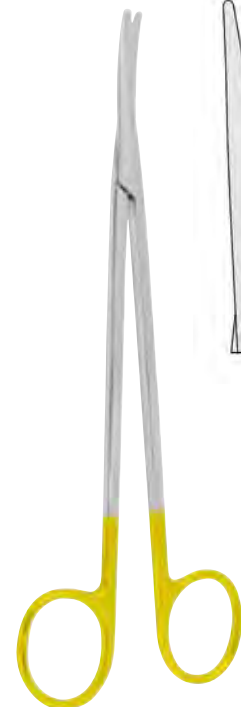


18,0 cm, 7"	108.297.18
20,0 cm, 8"	108.297.20
23,0 cm, 9"	108.297.23
25,0 cm, 10"	108.297.25
28,0 cm, 11"	108.297.28
30,0 cm, 12"	108.297.30

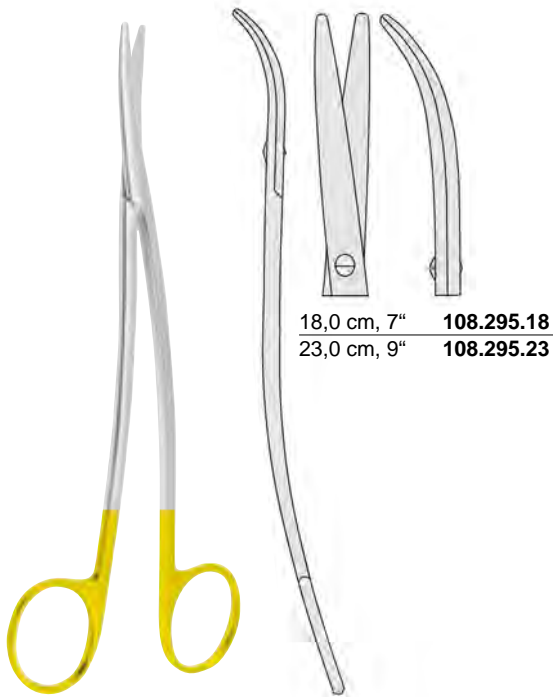
METZENBAUM-FINO



METZENBAUM-LAHEY
 14,0 cm, 5½"

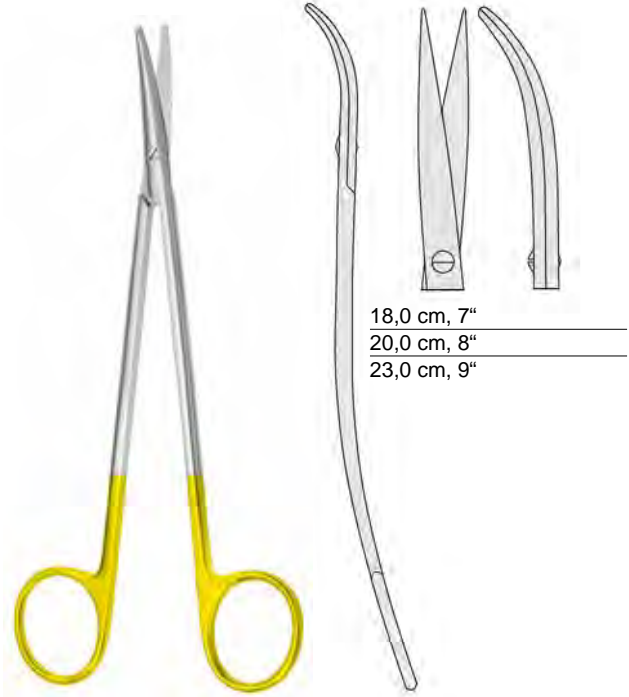


TOENNIS-ADSON
 17,0 cm, 6¾"
108.609.17



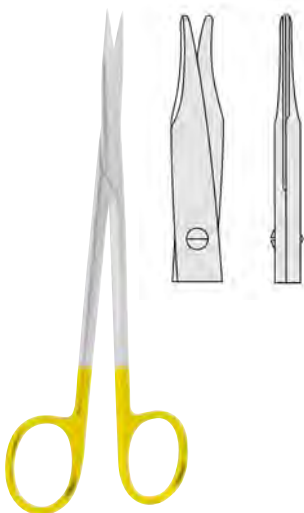
18,0 cm, 7" **108.295.18**
23,0 cm, 9" **108.295.23**

METZENBAUM-FINO S

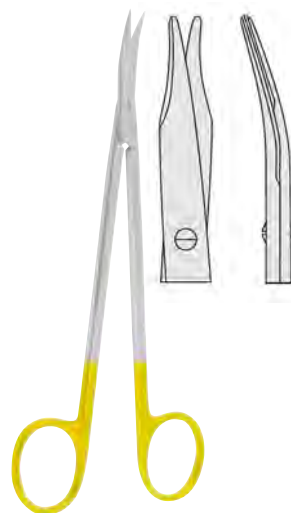


18,0 cm, 7"
20,0 cm, 8"
23,0 cm, 9"

METZENBAUM-FINO S



REYNOLDS
15,0 cm, 6"
108.324.15



REYNOLDS
15,0 cm, 6"
108.325.15



HYSTEREKTOMY
25,0 cm, 10"
108.505.25



HYSTEREKTOMY
25,0 cm, 9³/₄"
108.506.25

Gynäkologische Scheren mit Hartmetallschneiden
Gynecology Scissors with tungsten carbide edges
Tijeras para ginecología con filos de carburo tungsteno
Forbici per ginecologia con lame in carburo di tungsteno



23,0 cm, 9" **108.514.23**



SIMS



23,0 cm, 9" **108.515.20**



SIMS



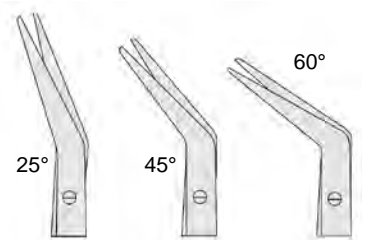
DIETRICH
17,5 cm, 6⁵/₈"



POTTS DE MARTEL
24,0 cm, 9¹/₂"



DE BAKEY



23,0 cm, 9"

108.493.23

108.495.23

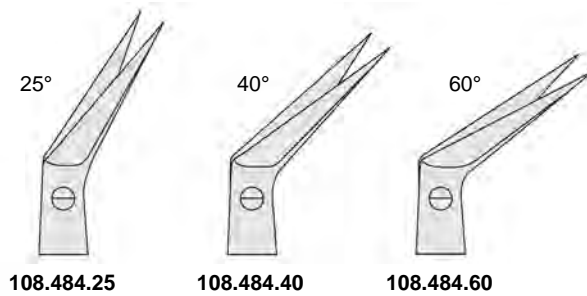
Gefäßscheren mit Hartmetallschneiden
Vascular Scissors with tungsten carbide edges
Tijeras vasculares con filos de carburo tungsteno
Forbici vascolari con lame in carburo di tungsteno

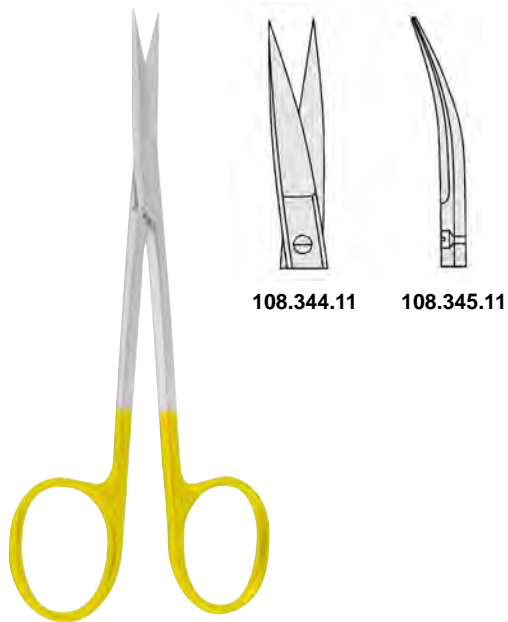


DIETRICH-HEGEMANN
18,0 cm, 7"



POTTS-SMITH
19,0 cm, 7½"

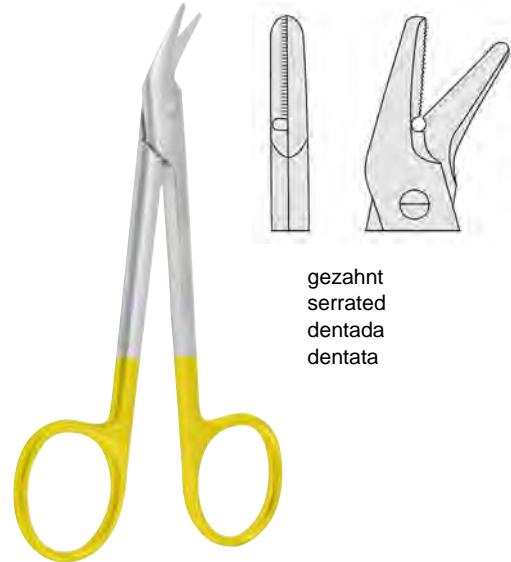




108.344.11

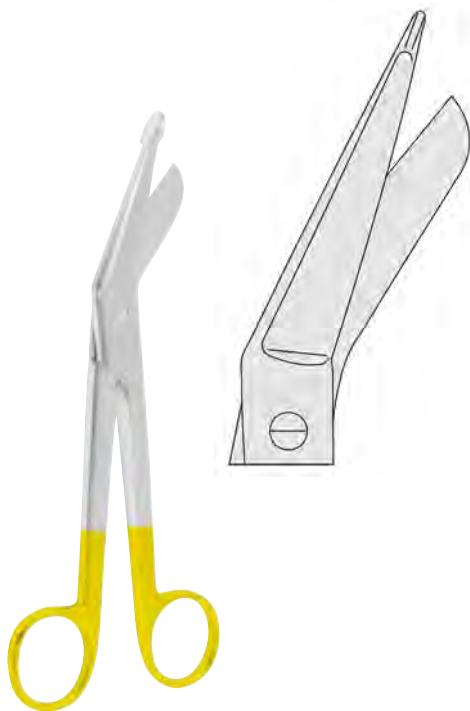
108.345.11

IRIS
11,5 cm, 4 1/2"

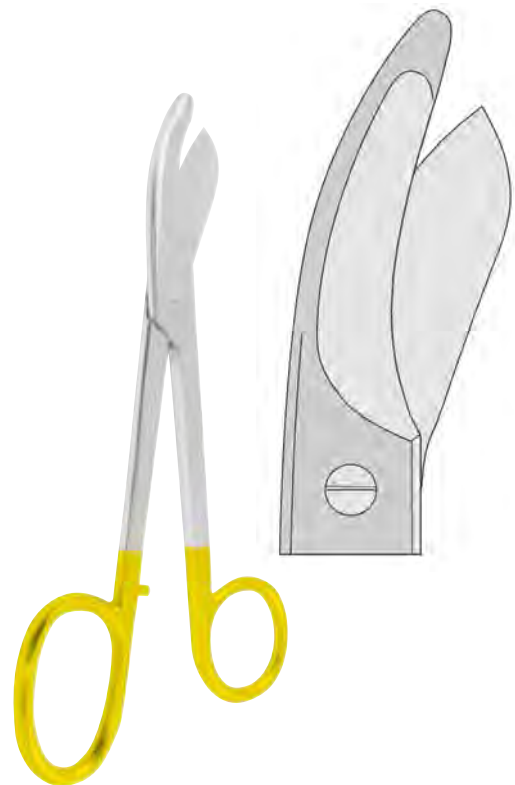


gezahnt
serrated
dentada
dentata

UNIVERSAL
12,0 cm, 4 3/4"
108.835.12

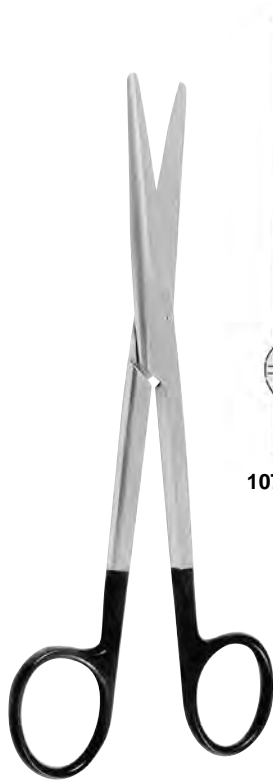


LISTER
18,0 cm **108.905.18**
20,0 cm **108.905.20**

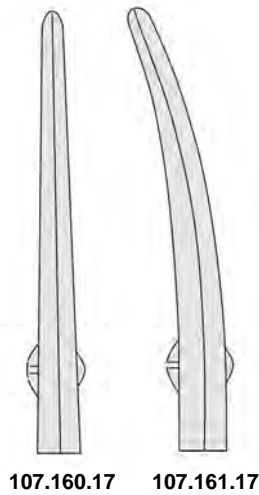


BRUNS
24,0 cm, 9 1/2"
108.939.23

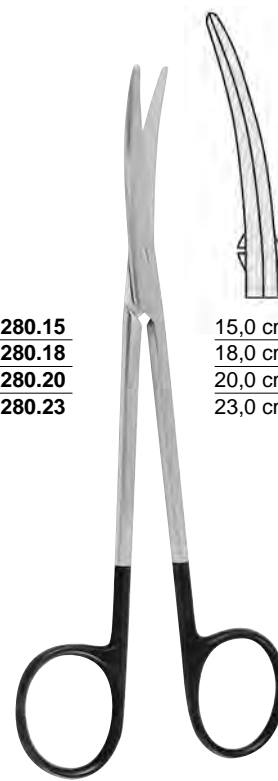
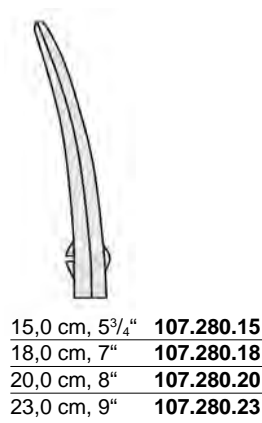
Super-Cut Scheren
 Super-Cut Scissors
 Tijeras Super-Cut
 Forbici Super-Cut



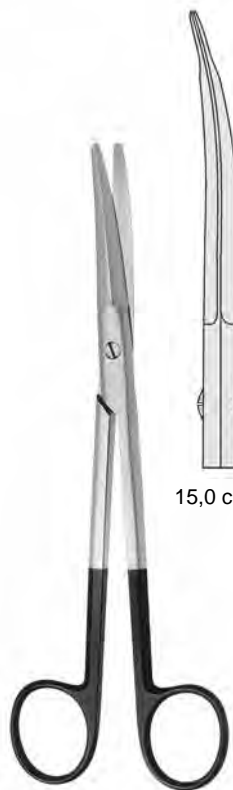
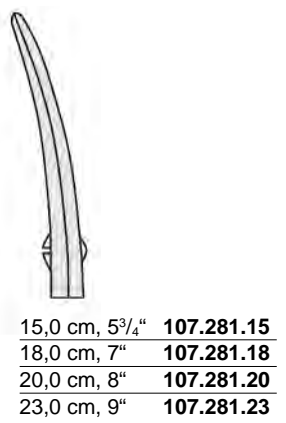
MAYO
 17,0 cm, 6³/₄"



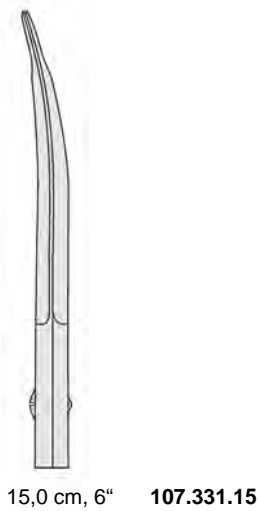
METZENBAUM



METZENBAUM



KAYE FACE LIFT



JABALEY
 13,0 cm, 5"



ENDARTERECTOMY
 18,0 cm, 7"



TOENNIS-ADSON
 17,0 cm, 6³/₄"



107.370.11

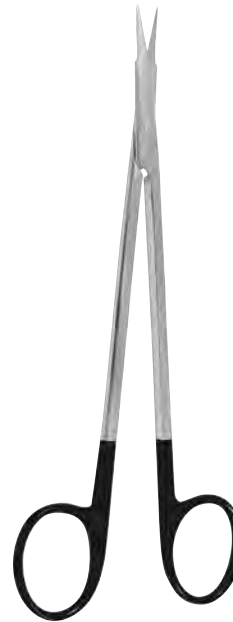
107.371.11

STRABISMUS
11,5 cm, 4½"



JAMISON

15,0 cm, 6"	107.323.15
18,0 cm, 7"	107.323.18



REYNOLDS
15,0 cm, 5"
107.320.15



BABY-METZENBAUM
11,5 cm, 4¾"
107.280.11
15,0 cm, 5¾"
107.280.15



IRIS
11,5 cm, 4¾"
107.340.11



IRIS
11,5 cm, 4¾"
107.341.11



STEVENS TENOTOMY
11,5 cm, 4¾"
107.362.11



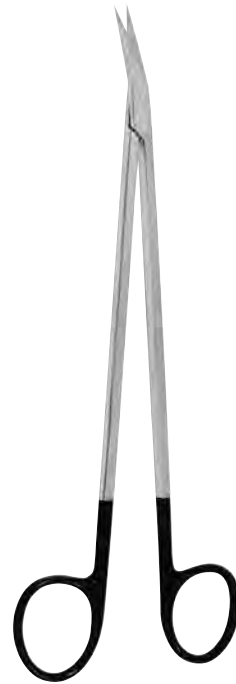
STEVENS T ENOTOMY
11,5 cm, 4¾"
107.363.11



KILNER
 12,0 cm, 4³/₄"
 107.310.12



PAR TYPE
 12,0 cm, 4³/₄"



POTTS
 19,0 cm, 7¹/₂"



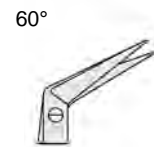
25°

107.480.25



45°

107.480.45



60°

107.480.60

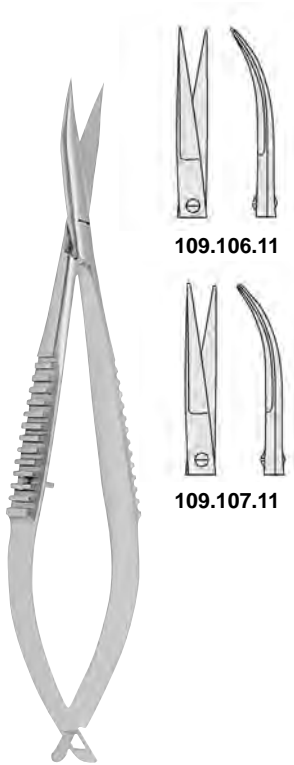


FOMON
 14,5 cm, 5³/₄"
 107.403.15



COTTLE
 16,0 cm, 6¹/₂"
 107.405.16





109.106.11

109.107.11

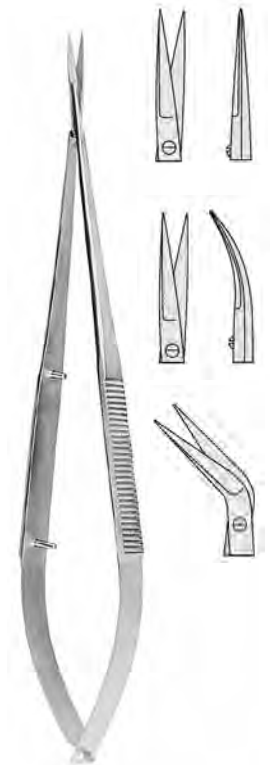
WESTCOTT
11,0 cm, 4³/₈"

14,0 cm, 5¹/₂"
18,0 cm, 6¹/₄"



109.202.14
109.202.18


109.203.14
109.203.18



18,5 cm, 7¹/₄"



YASARGIL



16,5 cm, 7¹/₄" **109.250.16** **109.251.16**
22,5 cm, 8³/₄" **109.250.22** **109.251.22**

Mikro-Scheren, Mikro-Disektionsscheren
Micro Scissors, Micro Dissecting Scissors
Micro-Tijeras, Micro-Tijeras de disección
Micro-Forbici, Micro-Forbici per dissezione



Pinzetten

Forceps

Pinzas

Pinze



schmal
 narrow
 estrechos
 stretti



schmal
 narrow
 estrechos
 stretti

STANDARD

10,5 cm, 4 ¹ / ₈ "	110.102.10
11,5 cm, 4 ¹ / ₂ "	110.102.11
13,0 cm, 5"	110.102.13
14,5 cm, 5 ³ / ₄ "	110.102.14
16,0 cm, 6 ¹ / ₄ "	110.102.16
18,0 cm, 7"	110.102.18
20,0 cm, 8"	110.102.20
25,0 cm, 10"	110.102.25
30,0 cm, 12"	110.102.30

STANDARD

10,5 cm, 4 ¹ / ₈ "	110.103.10
11,5 cm, 4 ¹ / ₂ "	110.103.11
13,0 cm, 5"	110.103.13
14,5 cm, 5 ³ / ₄ "	110.103.14
16,0 cm, 6 ¹ / ₄ "	110.103.16
18,0 cm, 7"	110.103.18
20,0 cm, 8"	110.103.20

STANDARD

10,5 cm, 4 ¹ / ₈ "	110.110.10
11,5 cm, 4 ¹ / ₂ "	110.110.11
13,0 cm, 5"	110.110.13
14,5 cm, 5 ³ / ₄ "	110.110.14
16,0 cm, 6 ¹ / ₄ "	110.110.16
18,0 cm, 7"	110.110.18
20,0 cm, 8"	110.110.20
25,0 cm, 10"	110.110.25
30,0 cm, 12"	110.110.30



MOD. USA

12,0 cm, 4 ³ / ₄ "	110.104.12
13,0 cm, 5"	110.104.13
14,5 cm, 5 ³ / ₄ "	110.104.14
15,0 cm, 6"	110.104.15
18,0 cm, 7"	110.104.18
21,0 cm, 8"	110.104.20
25,5 cm, 10"	110.104.25
30,0 cm, 12"	110.104.30



ADSON

12,0 cm, 4 ³ / ₄ "	110.170.12
15,0 cm, 6"	110.170.15



MICRO-ADSON

12,0 cm, 4 ³ / ₄ "	110.176.12
15,0 cm, 6"	110.179.15



STILLE

15,0 cm, 6"	110.106.15
-------------	-------------------



MC INDOE

15,0 cm, 6"	110.258.15
-------------	-------------------



TAYLOR

17,5 cm, 6 ⁵ / ₈ "	110.274.17
--	-------------------



TAYLOR

17,5 cm, 6 ⁵ / ₈ "	
--	--



TAYLOR

18,5 cm, 7 ¹ / ₄ "	
--	--



GERALD

18,0 cm, 7"	110.302.18
-------------	-------------------



GERALD
18,0 cm, 7"
110.303.18



POTTS-SMITH
18,0 cm, 7" **110.112.18**
21,0 cm, 8¹/₄" **110.112.21**
25,0 cm, 10" **110.112.25**



POTTS-SMITH
18,0 cm, 7"
21,0 cm, 8¹/₄"
25,0 cm, 10"



englische Modelle
english patterns
modelos ingleses
modelli inglese

13,0 cm, 5"
14,5 cm, 5³/₄"
15,0 cm, 6"



SEMKEN
12,5 cm, 5" **110.260.12**
15,0 cm, 6" **110.260.15**



CUSHING
17,5 cm, 6⁵/₈"
110.220.17



CUSHING
17,5 cm, 6⁵/₈"
110.221.17



BROPHY
20,0 cm, 8"

Anatomische Pinzetten
 Dissecting Forceps
 Pinzas de disección
 Pinze anatomiche per dissezione
 Пинцеты анатомические



BROPHY
 20,0 cm, 8"



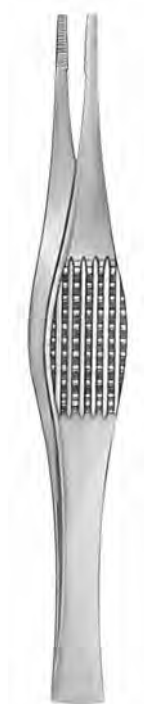
BONNEY
 18,0 cm, 7"
 110.255.18



SINGLEY
 23,0 cm, 9"
 110.320.23



WAUGH
 15,0 cm, 6" **110.262.15**
 20,0 cm, 8" **110.262.18**



RAMSEY
 18,0 cm, 7"
 110.346.18

 1 x 2



STANDARD

10,5 cm, 4 ¹ / ₈ "	110.120.10
11,5 cm, 4 ¹ / ₂ "	110.120.11
13,0 cm, 5"	110.120.13
14,5 cm, 5 ³ / ₄ "	110.120.14
16,0 cm, 6 ¹ / ₄ "	110.120.16
18,0 cm, 7"	110.120.18
20,0 cm, 8"	110.120.20
25,0 cm, 10"	110.120.25
30,0 cm, 12"	110.120.30

 2 x 3



11,5 cm, 4 ¹ / ₂ "	110.140.11
13,0 cm, 5"	110.140.13
14,5 cm, 5 ³ / ₄ "	110.140.14
16,0 cm, 6 ¹ / ₄ "	110.140.16
18,0 cm, 7"	110.140.18
20,0 cm, 8"	110.140.20
25,0 cm, 10"	110.140.25
30,0 cm, 12"	110.140.30

 3 x 4



13,0 cm, 5"	110.150.13
14,5 cm, 5 ³ / ₄ "	110.150.14
16,0 cm, 6 ¹ / ₄ "	110.150.16
18,0 cm, 7"	110.150.18
20,0 cm, 8"	110.150.20

 4 x 5



13,0 cm, 5"	110.160.13
14,5 cm, 5 ³ / ₄ "	110.160.14
16,0 cm, 6 ¹ / ₄ "	110.160.16
18,0 cm, 7"	110.160.18
20,0 cm, 8"	110.160.20

Chirurgische Pinzetten
Tissue Forceps
Pinzas quirúrgicas
Pinze per chirurgia
Пинцеты хирургические

fein
fine
finas
fini

↔ 1 x 2



11,5 cm, 5"	110.130.13
13,0 cm, 5"	110.130.13
14,5 cm, 5 ³ / ₄ "	110.130.14
16,0 cm, 6 ¹ / ₄ "	110.130.16
18,0 cm, 7"	110.130.18
20,0 cm, 8"	110.130.20
25,0 cm, 10"	110.130.25
30,0 cm, 12"	110.130.30

↔ 1 x 2



MOD. USA

12,0 cm, 4 ³ / ₄ "	110.122.12
13,0 cm, 5"	110.122.13
14,5 cm, 5 ³ / ₄ "	110.122.14
15,5 cm, 6"	110.122.15
18,0 cm, 7"	110.122.18
21,0 cm, 8 ¹ / ₄ "	110.122.20
25,0 cm, 10"	110.122.25
30,0 cm, 12"	110.122.30

↔ 2 x 3



MOD. USA

12,0 cm, 4 ³ / ₄ "	110.124.12
13,0 cm, 5"	110.124.13
14,5 cm, 5 ³ / ₄ "	110.124.14
15,5 cm, 6"	110.124.15
18,0 cm, 7"	110.124.18
20,0 cm, 8"	110.124.20
25,0 cm, 10"	110.124.25
30,0 cm, 12"	110.124.30

↔ 1 x 2



ADSON

12,0 cm, 4 ³ / ₄ "	110.180.12
15,0 cm, 6"	110.180.15

↔ 1 x 2



MICRO-ADSON

12,0 cm, 4 ³ / ₄ "	110.186.12
15,0 cm, 6"	110.186.15

2 x 3



ADSON

12,0 cm, 4³/₄"
 15,0 cm, 6"

7 x 7



ADSON-BROWN

12,0 cm, 4³/₄" **110.188.12**
 15,0 cm, 6" **110.188.15**

1 x 2



ADSON mit Fadenplatte

12,0 cm, 4³/₄"
110.179.12

1 x 2



GILLIES

15,0 cm, 6"
110.272.15

4 x 5



ADLERKREUTZ

15,0 cm, 6" **110.236.15**
 20,0 cm, 8" **110.236.20**

1 x 2



SEMKEN

12,5 cm, 5" **110.270.12**
15,5 cm, 6" **110.270.15**

2 x 3



SEMKEN

12,5 cm, 5" **110.270.13**

1 x 2



MC INDOE

15,0 cm, 6" **110.259.15**

1 x 2



TAYLOR

17,5 cm, 6⁵/₈" **110.280.17**

1 x 2



TAYLOR

17,5 cm, 6⁵/₈"

1 x 2



TAYLOR

17,5 cm, 6⁵/₈"

1 x 2



GERALD

18,0 cm, 7" **110.310.18**

1 x 2



GERALD

18,0 cm, 7" **110.311.18**

Chirurgische Pinzetten
Tissue Forceps
Pinzas quirúrgicas
Pinze per chirurgia

↻ 1 x 2



CUSHING
17,5 cm, 6⁵/₈"
110.230.17

↻ 1 x 2



CUSHING
17,5 cm, 6⁵/₈"
110.231.17

↻ 1 x 2



POTTS-SMITH
18,0 cm, 7" 110.126.18
21,0 cm, 8¹/₄" 110.126.21
25,0 cm, 10" 110.126.25

↻ 1 x 2



POTTS-SMITH
18,0 cm, 7"
21,0 cm, 8¹/₄"
25,0 cm, 10"

↻ 1 x 2



WAUGH
15,0 cm, 6" 110.282.15
20,0 cm, 8" 110.282.20

↻ 1 x 2



BROPHY
20,0 cm, 8"
110.290.20

↻ 1 x 2



BROPHY
20,0 cm, 8"
110.291.20



RUSS. MODELL
15,0 cm, 6" 110.256.15
20,0 cm, 8" 110.256.20
25,0 cm, 10" 110.256.25



DURANTE

14,5 cm, 5 ³ / ₄ "	110.316.14
16,0 cm, 6 ¹ / ₄ "	110.316.16
20,0 cm, 8"	110.316.20



NELSON

15,0 cm, 6"	110.322.15
23,0 cm, 9"	110.322.23



Fig. 1

DUVAL
14,5 cm, 5¹/₂"




COLLIN-DUVAL
20,0 cm, 8"



Fig. 1
110.252.14



Fig. 3
110.252.25

 1 x 2



LANE

14,5 cm, 5 ³ / ₄ "	110.246.14
20,0 cm, 8"	110.246.20

 2 x 3



LANE

14,5 cm, 5 ³ / ₄ "	110.242.14
20,0 cm, 8"	110.242.20

7 x 7



BROWN

16,0 cm, 6"	110.189.16
20,0 cm, 8"	110.189.20
25,0 cm, 10"	110.189.25

 1 x 2



TREVES

13,0 cm, 5"	110.132.13
15,0 cm, 6"	110.132.15
18,0 cm, 7"	110.132.18

 1 x 2



RAMSEY
 18,0 cm, 7"
110.342.18



8,0 cm, 3 ¹ / ₄ "	110.802.08
9,0 cm, 3 ¹ / ₂ "	110.802.09
10,5 cm, 4 ¹ / ₈ "	110.802.10
11,5 cm, 4 ¹ / ₂ "	110.802.11
12,5 cm, 5"	110.802.13

8,0 cm, 3 ¹ / ₄ "	110.803.08
9,0 cm, 3 ¹ / ₂ "	110.803.09
10,5 cm, 4 ¹ / ₈ "	110.803.10
11,5 cm, 4 ¹ / ₂ "	110.803.11
12,5 cm, 5"	110.803.13

Splitterpinzetten, Mikro-Pinzetten
Splinter Forceps, Micro Forceps
Pinzas para espinas, Pinzas para microscopia
Pinze per schegge, Pinze per microscopia



HUNTER
 10,5 cm, 4¹/₄"
110.812.10



HUNTER
 10,5 cm, 4¹/₄"
110.813.10



WALTER-CARMALT
 10,5 cm, 4¹/₄"
110.816.10



WALTER-CARMALT
 10,5 cm, 4¹/₄"
110.817.10



FEILCHENFELD
 7,5 cm, 3¹/₈" **110.810.07**
 9,0 cm, 3¹/₂" **110.810.09**
 11,5 cm, 4¹/₂" **110.810.11**



10,0 cm, 4"
110.804.10

glatt



GRAEFE
10,0 cm, 4"
142.810.10



GRAEFE
10,0 cm, 4"
142.811.10



GRAEFE
10,0 cm, 4"
142.813.10



GRAEFE
10,0 cm, 4"
142.820.10



GRAEFE
10,0 cm, 4"
142.821.10



GRAEFE
10,0 cm, 4"
142.823.10



Fig. 3
11,5 cm, 4 1/2"
110.330.12



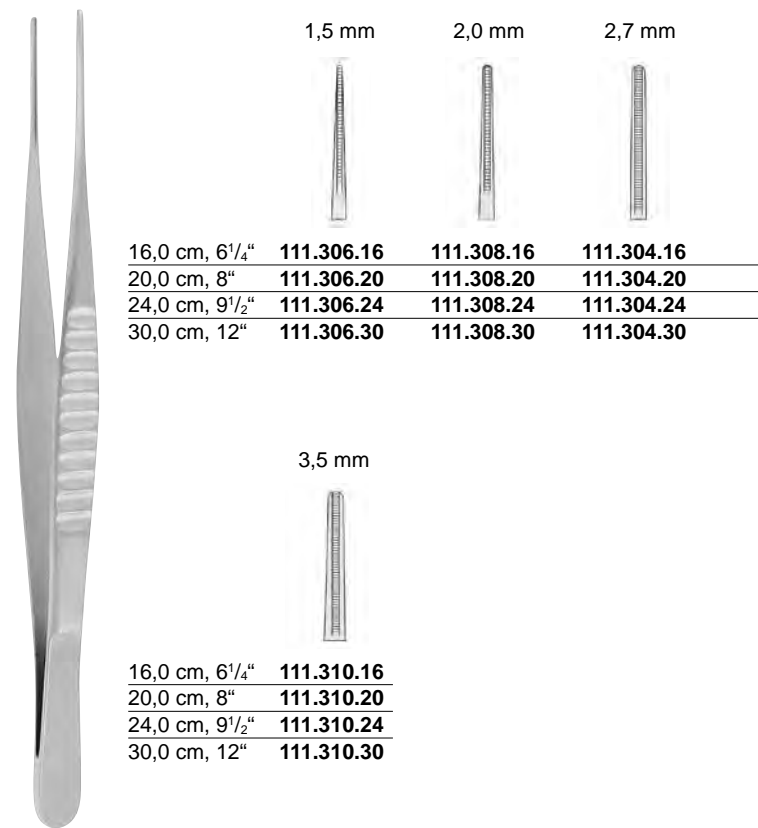
Fig. 4
11,5 cm, 4 1/2"
110.332.04



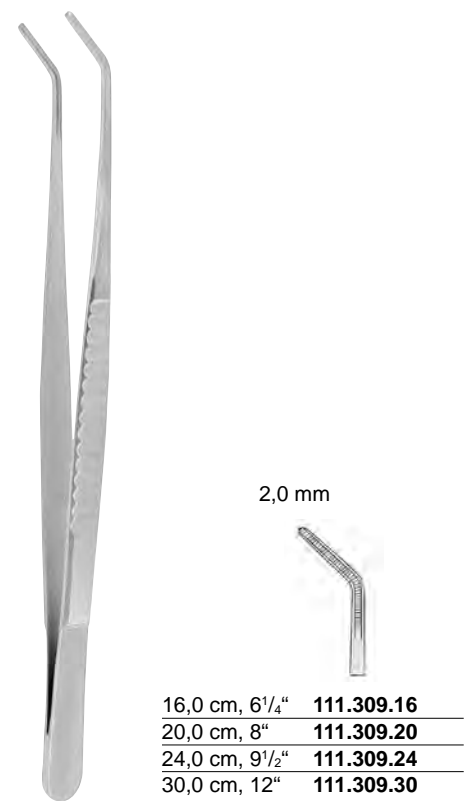
Fig. 5
11,5 cm, 4 1/2"
110.332.05



Fig. 7
11,5 cm, 4 1/2"
110.331.12



DE BAKEY



DE BAKEY

Pinzetten mit Hartmetalleinlagen
 Forceps with tungsten carbide inserts
 Pinzas con bocas de carburo tungsteno
 Pinze con morsi in carburo di tungsteno



STANDARD

14,5 cm, 5 ³ / ₄ "	110.113.14
16,0 cm, 6 ¹ / ₄ "	110.113.16
18,0 cm, 7"	110.113.18
20,0 cm, 8"	110.113.20
25,0 cm, 10"	110.113.25



STANDARD

14,0 cm, 5 ¹ / ₂ "	110.121.14
16,0 cm, 6 ¹ / ₄ "	110.121.16
18,0 cm, 7"	110.121.18
20,0 cm, 8"	110.121.20



STANDARD

12,5 cm, 5"	110.274.12
-------------	-------------------



STANDARD

15,0 cm, 6"	110.326.15
23,0 cm, 9"	110.326.23



GILLIES
15,0 cm, 6"
110.272.16



MC INDOE
15,0 cm, 6"
110.257.15



POTTS-SMITH
15,0 cm, 6" **110.116.15**
18,0 cm, 7" **110.116.18**
21,0 cm, 8" **110.116.21**



110.224.17

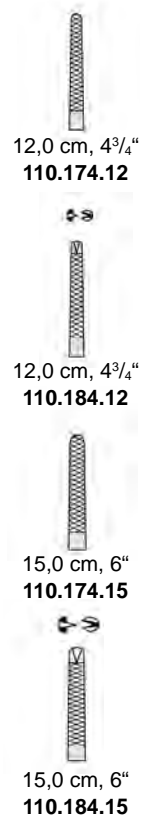
CUSHING
17,5 cm, 6⁵/₈"



CUSHING-TAYLOR
18,0 cm, 7"



ADSON
17,5 cm, 6⁵/₈"



Klemmen

Forceps

Pinas

Pinze



3,5 cm, 1 1/2"	112.102.04	112.103.03
5,0 cm, 2"	112.102.05	112.103.05



DIEFFENBACH



DE BAKEY
112.057.20



DE BAKEY
112.057.30



3,8 cm, 1 1/2"	112.110.40	112.111.04
5,0 cm, 2"	112.110.05	112.111.05
6,3 cm, 2 1/2"	112.110.06	112.111.06
7,6 cm, 3"	112.110.07	112.111.07
9,0 cm, 3 1/2"	112.110.09	112.111.09



JOHNS-HOPKINS



JOHNS-HOPKINS
 23,0 cm, 9"
112.091.23



mit atraumatischer Riefung
with non-traumatic serration
con bocas atraumáticas
con presa atraumatica
с атравматичной зазубреностью

		L
7,5 cm, 3"	112.092.07	2,5 cm, 1"
8,5 cm, 3 ¹ / ₄ "	112.092.08	3,5 cm, 1 ³ / ₈ "
10,5 cm, 4 ¹ / ₈ "	112.092.10	5,0 cm, 2"
12,0 cm, 4 ³ / ₄ "	112.092.12	6,8 cm, 2 ³ / ₄ "

DE BAKEY



mit atraumatischer Riefung
with non-traumatic serration
con bocas atraumáticas
con presa atraumatica
с атравматичной зазубреностью

		L
7,0 cm, 2 ³ / ₄ "	112.093.07	2,5 cm, 1"
8,0 cm, 3 ¹ / ₈ "	112.093.08	3,5 cm, 1 ³ / ₈ "
10,0 cm, 3 ³ / ₄ "	112.093.10	5,0 cm, 2"
11,5 cm, 4 ¹ / ₂ "	112.093.12	6,8 cm, 2 ³ / ₄ "

DE BAKEY



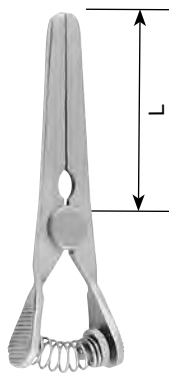
TITANIUM
3,5 cm, 1³/₈"
vena **112.054.01**
arteria **112.054.02**



TITANIUM
3,5 cm, 1³/₈"
vena **112.051.01**
arteria **112.051.02**

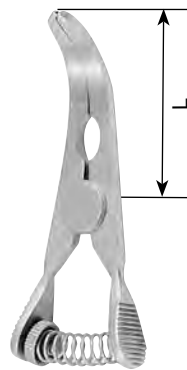


TITANIUM
4,0 cm, 1⁵/₈"
vena **112.052.01**
arteria **112.052.02**



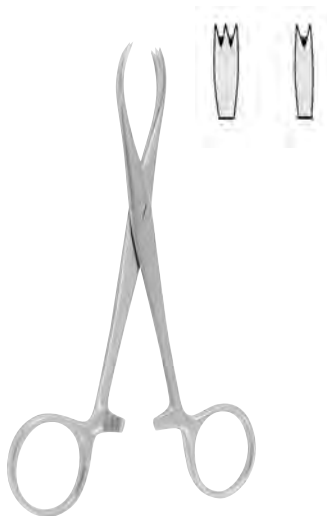
		L	
6,8 cm, 2 ³ / ₄ "	112.096.06	3,3 cm, 1 ³ / ₈ "	
9,6 cm, 3 ³ / ₄ "	112.096.09	5,0 cm, 2"	
11,7 cm, 4 ³ / ₄ "	112.096.11	6,9 cm, 2 ³ / ₄ "	

GLOVER



		L	
6,5 cm, 2 ¹ / ₂ "	112.097.06	3,3 cm, 1 ³ / ₈ "	
9,1 cm, 3 ¹ / ₂ "	112.097.09	5,0 cm, 2"	
11,0 cm, 4 ³ / ₈ "	112.097.11	6,9 cm, 2 ³ / ₄ "	

GLOVER



CHAPUT
 13,0 cm, 5"
112.370.13



TUFFIER
 13,0 cm, 5"
112.372.13



COLLIN
 16,0 cm, 6¹/₄"
112.376.16



PENNINGTON
15,5 cm, 6" **112.358.15**
20,0 cm, 8" **112.358.20**



ATRAUMA



25,0 cm, 9³/₄"
113.270.25



26,0 cm, 10¹/₂"
113.270.26



MARTEL
14,0 cm, 5¹/₂"
112.364.14



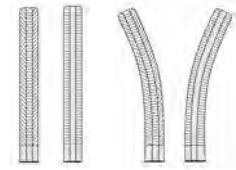
WILLET-MARTEL
19,0 cm, 7¹/₂"
112.366.19



PRATT
 15,0 cm, 6"
 112.360.15



FERGUSSON



16,0 cm, 6 ¹ / ₄ "	112.350.16	112.351.16
20,0 cm, 8"	112.350.20	112.351.20



CARREL
 8,5 cm
 112.208.08



TERRIER
 8,5 cm
 112.206.08



PEAN

14,0 cm, 5 1/2" **112.368.14**
16,0 cm, 6 1/4" **112.368.16**



112.475.14

BABY-MIXTER

14,0 cm, 5 1/2"



SPENCER-WELLS

13,0 cm, 5"	112.330.13	112.331.13
15,0 cm, 6"	112.330.15	112.331.15
18,0 cm, 7"	112.330.18	112.331.18
20,0 cm, 8"	112.330.20	112.331.20



HARTMANN

10,0 cm, 4"

112.210.10

112.211.10

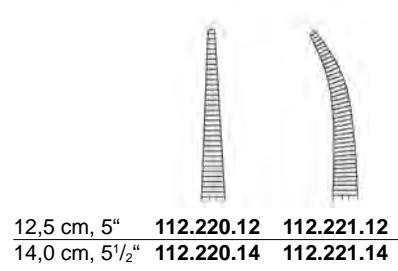


112.271.14

PROVICENCE-HOSPITAL
 14,0 cm, 5½"



HALSTED-MOSQUITO



12,5 cm, 5" **112.220.12** **112.221.12**
 14,0 cm, 5½" **112.220.14** **112.221.14**

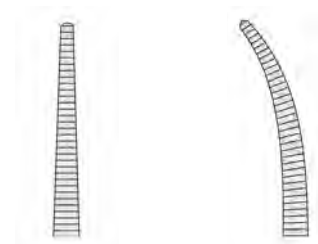
1 x 2 1 x 2



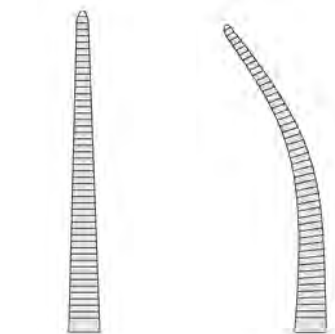
12,5 cm, 5" **112.230.12** **112.231.12**
 14,0 cm, 5½" **112.230.14** **112.231.14**



HALSTED-MOSQUITO



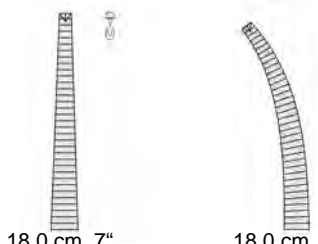
18,0 cm, 7" **112.220.18** 18,0 cm, 7" **112.221.18**



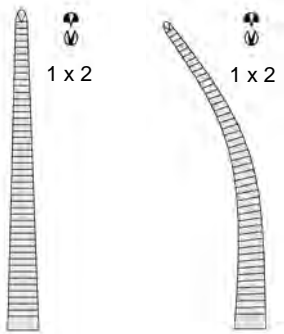
21,0 cm, 8¼" **112.220.21** 21,0 cm, 8¼" **112.221.21**

1 x 2

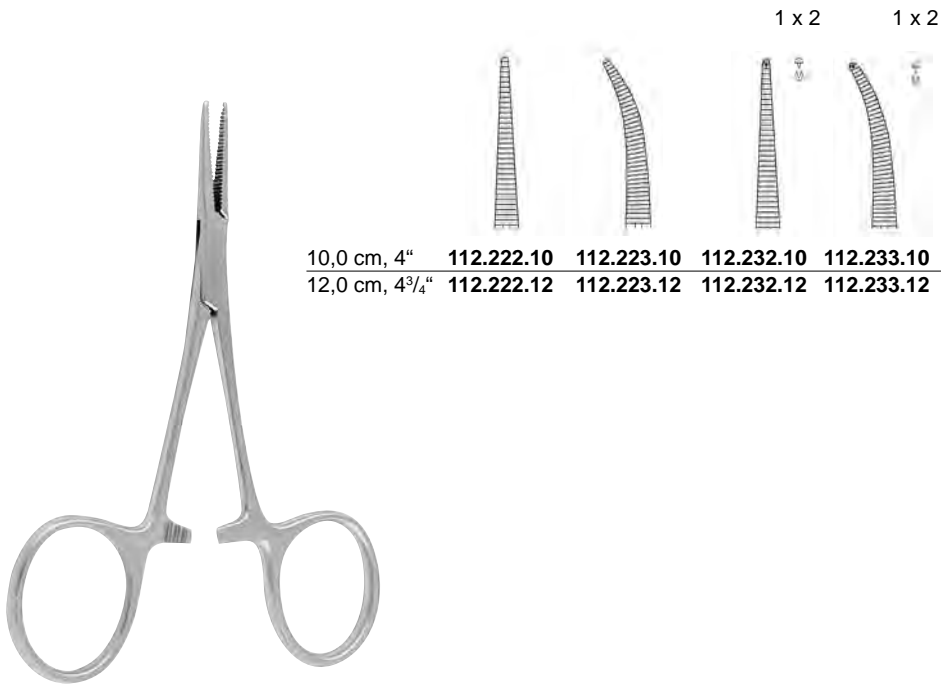
1 x 2



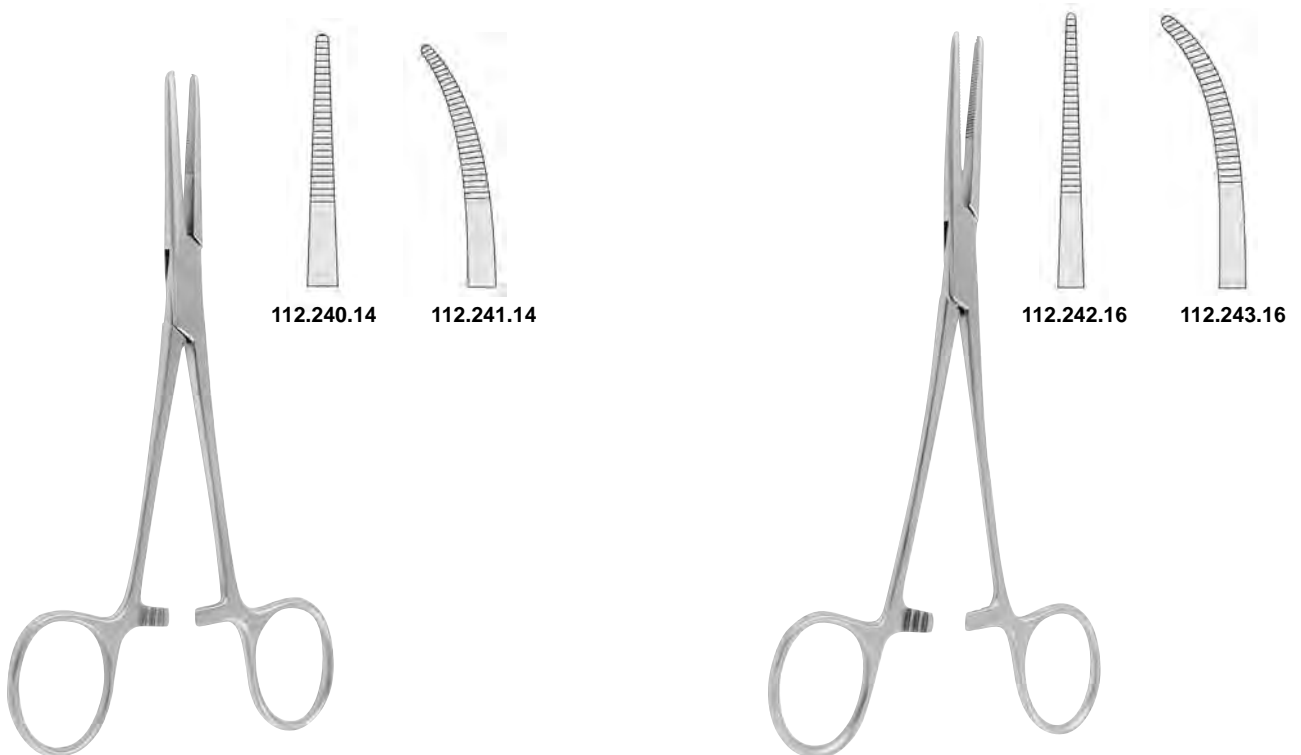
18,0 cm, 7" **112.230.18** 18,0 cm, 7" **112.231.18**



21,0 cm, 8¼" **112.230.21** 21,0 cm, 8¼" **112.231.21**



MICRO-MOSQUITO



112.240.14

112.241.14

112.242.16

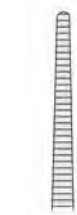
112.243.16

KELLY
14,0 cm, 5¹/₂"

KELLY-RANKIN
16,0 cm, 6¹/₄"



LERICHE
 15,0 cm, 6"



112.380.15



112.381.15



112.382.15



112.383.15



BABY-OVERHOLT
 13,5 cm, 5 1/4"
 112.421.13



DANDY
 14,0 cm, 5 1/2"



112.245.14



CRILE
 14,0 cm, 5 1/2"



112.250.14



112.251.14



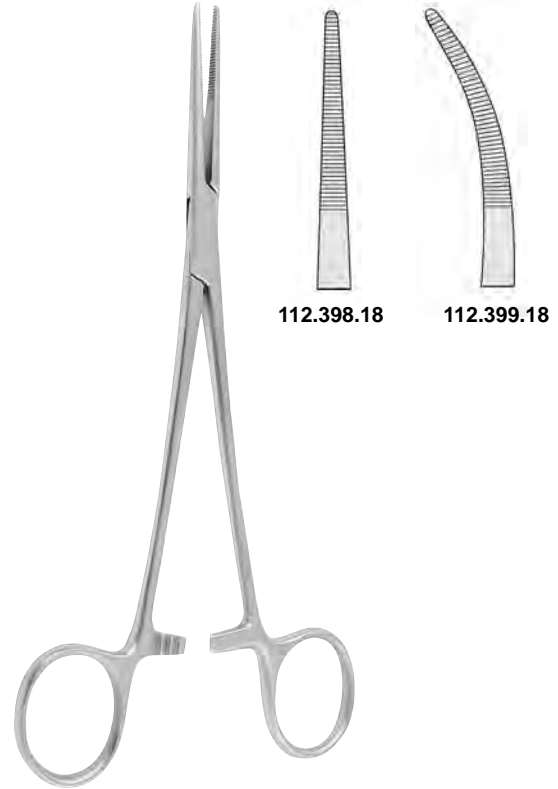
112.260.14



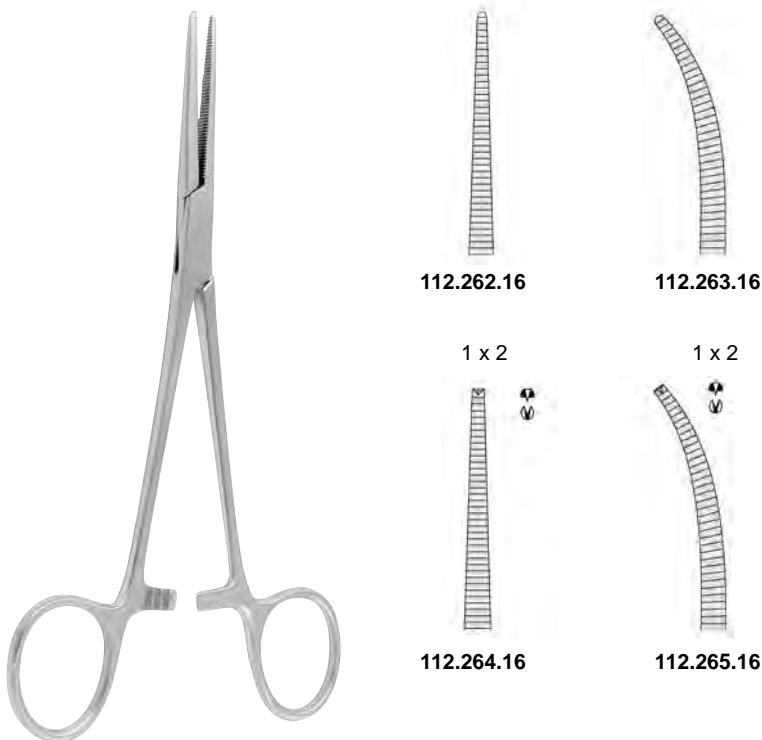
112.261.14



DIXON-LOVELACE
15,0 cm, 6"

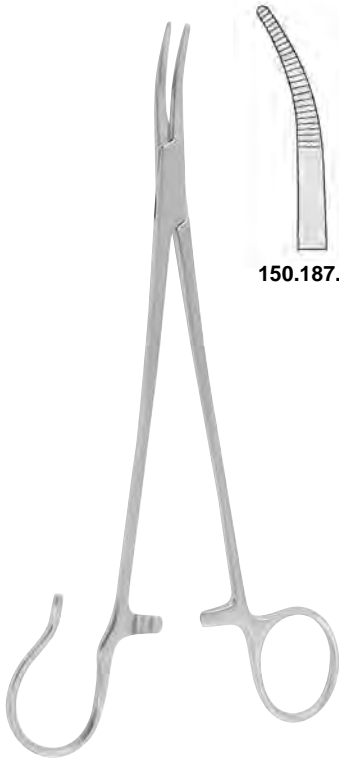


BIRKETT
19,0 cm, 7 1/2"



CRILE-RANKIN
16,0 cm, 6 1/4"

Arterienklemmen
 Haemostatic Forceps
 Pinzas hemostáticas
 Pinze emostatiche



150.187.19



150.185.19



150.183.19



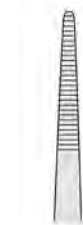
150.181.19

SCHNIDT
 19,0 cm, 7½"

SCHNIDT-SAWTELL
 19,0 cm, 7½"



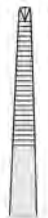
ADSON
 18,5 cm, 7¼"



112.410.18



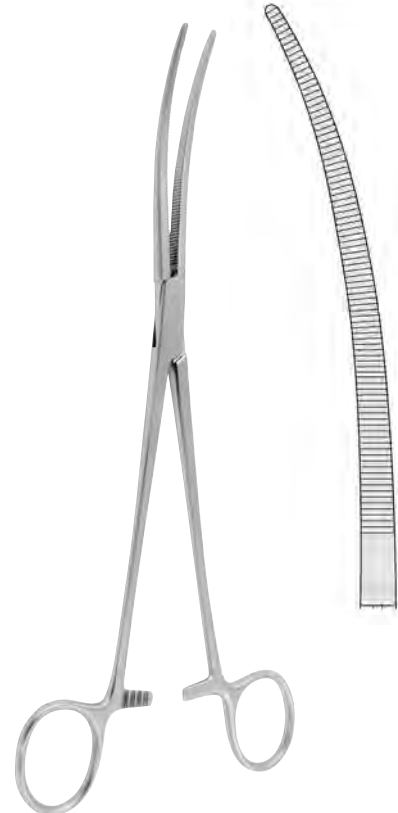
112.411.18



112.412.18



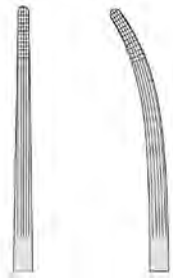
112.413.18



CRAFOORD
 24,0 cm, 9½"
 112.453.24



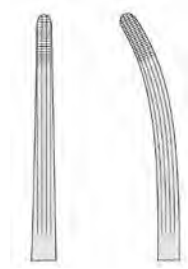
15,0 cm, 6"	112.480.15	112.481.15
18,5 cm, 7 ¹ / ₄ "	112.480.18	112.481.18



BAINBRIDGE



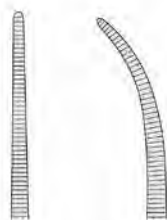
16,0 cm, 6 ¹ / ₄ "	112.340.16	112.341.16
20,0 cm, 8"	112.340.20	112.341.20



ROCHESTER-CARMALT



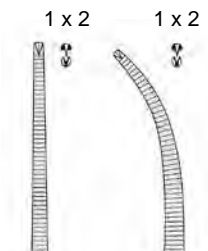
13,0 cm, 5"	112.312.13	112.313.13
14,0 cm, 5 ¹ / ₂ "	112.312.14	112.313.14
16,0 cm, 6 ¹ / ₄ "	112.312.16	112.313.16



PEAN DELICATE



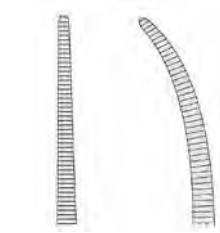
13,0 cm, 5"	112.322.13	112.323.13
14,0 cm, 5 ¹ / ₂ "	112.322.14	112.323.14
16,0 cm, 6 ¹ / ₄ "	112.322.16	112.323.16



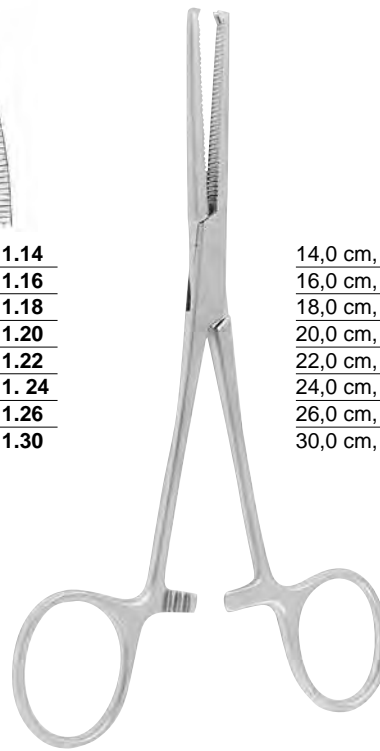
KOCHER DELICATE



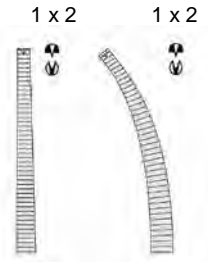
ROCHESTER-PEAN



14,0 cm, 5 1/2"	112.310.14	112.311.14
16,0 cm, 6 1/4"	112.310.16	112.311.16
18,0 cm, 7"	112.310.18	112.311.18
20,0 cm, 8"	112.310.20	112.311.20
22,0 cm, 8 5/8"	112.310.22	112.311.22
24,0 cm, 9 1/2"	112.310.24	112.311.24
26,0 cm, 10 1/4"	112.310.26	112.311.26
30,0 cm, 12"	112.310.30	112.311.30



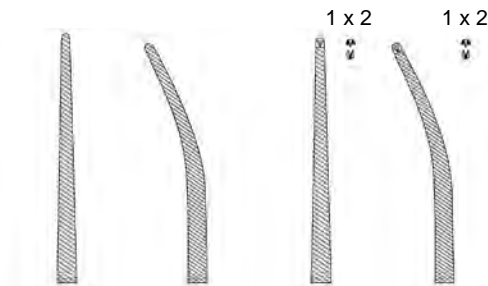
KOCHER-OCHSNER



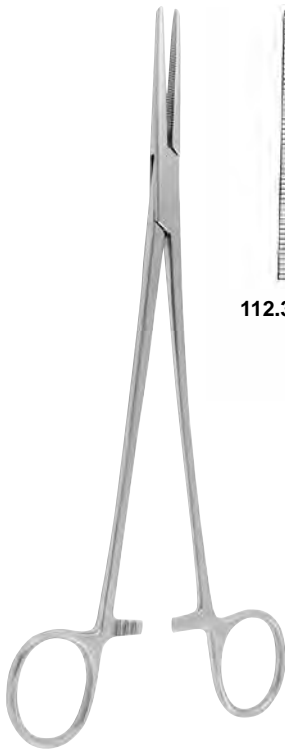
14,0 cm, 5 1/2"	112.320.14	112.321.14
16,0 cm, 6 1/4"	112.320.16	112.321.16
18,0 cm, 7"	112.320.18	112.321.18
20,0 cm, 8"	112.320.20	112.321.20
22,0 cm, 8 5/8"	112.320.22	112.321.22
24,0 cm, 9 1/2"	112.320.24	112.321.24
26,0 cm, 10 1/4"	112.320.26	112.321.26
30,0 cm, 12"	112.320.30	112.321.30



BENGOLEA



20,0 cm, 8"	112.384.20	112.385.20	112.386.20	112.387.20
26,0 cm, 10 1/4"	112.384.26	112.385.26	112.386.26	112.387.26



112.390.20

112.391.20

112.393.20

HEISS
20,0 cm, 8"



112.448.22

112.449.22

ROBERTS
22,0 cm, 8⁵/₈"



112.450.24

112.451.24

SAROT
24,0 cm, 9¹/₂"



150.193.19

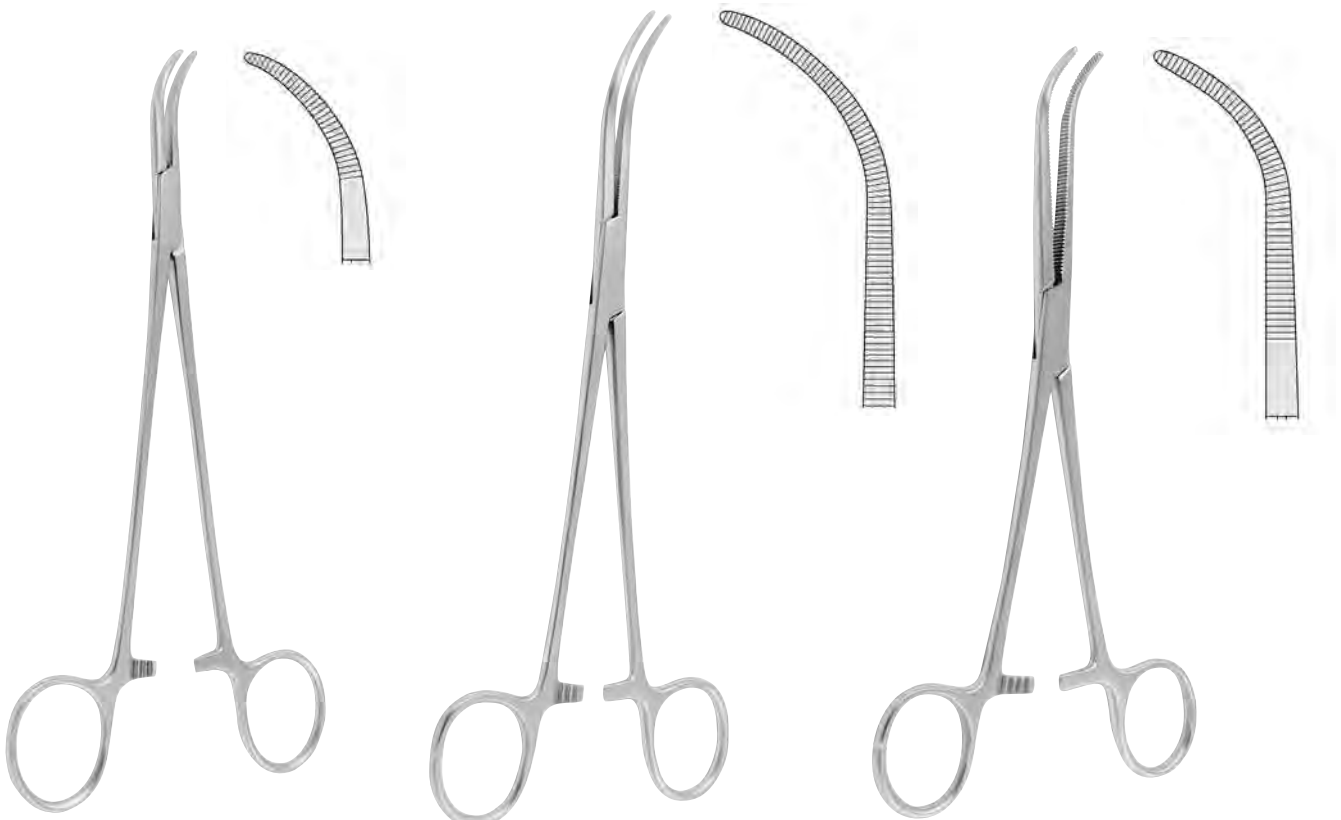
150.191.19

NEGUS
19,0 cm, 7¹/₂"



14,0 cm, 5½"
112.415.14 18,0 cm, 7"
112.415.18

BABY-ADSON



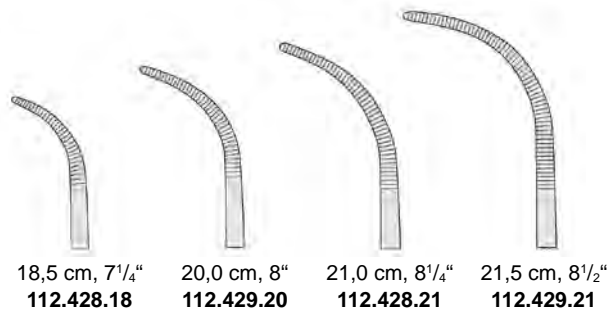
BABY-MIXTER
18,0 cm, 7"
112.475.18

OVERHOLT-MIXTER
21,0 cm, 8¼"
112.476.21

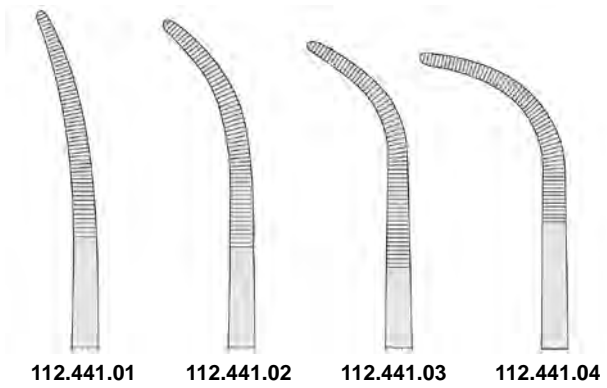
JOHNS HOPKINS
20,0 cm, 8"
112.497.20

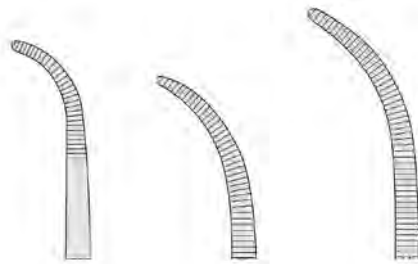


OVERHOLT

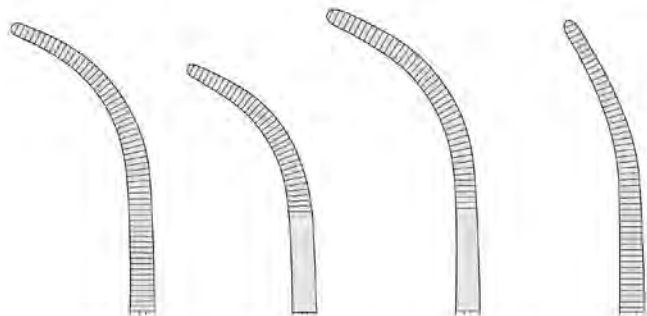


RUMEL
23,0 cm, 9"





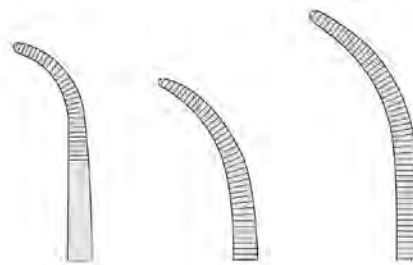
112.421.01 20,5 cm, 7³/₄"
112.421.02 20,0 cm, 7¹/₂"
112.421.03 21,5 cm, 8¹/₄"



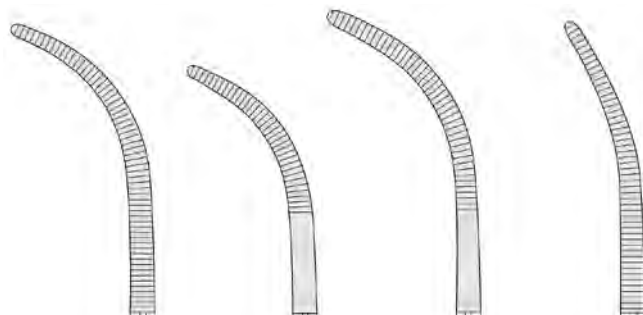
112.421.04 22,0 cm, 8³/₄"
112.421.05 21,5 cm, 8¹/₂"
112.421.06 22,0 cm, 8³/₄"
112.421.07 22,0 cm, 8³/₄"



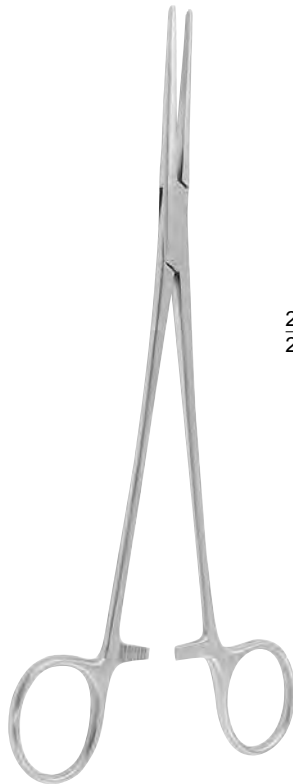
OVERHOLT-GEISSENDOERFER



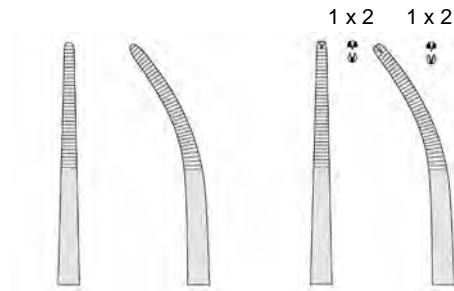
112.427.01 27,0 cm, 10³/₄"
112.427.02 26,0 cm, 10¹/₄"
112.427.03 27,0 cm, 10³/₄"



112.427.04 27,5 cm, 10³/₄"
112.427.05 27,5 cm, 10³/₄"
112.427.06 28,0 cm, 11"
112.427.07 28,0 cm, 11"



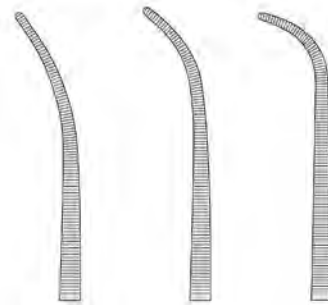
TOENNIS



21,0 cm, 8 ¹ / ₄ "	112.442.21	112.443.21	112.444.21	112.445.21
26,0 cm, 10 ¹ / ₄ "	112.442.26	112.443.26	112.444.26	112.445.26



KELLY

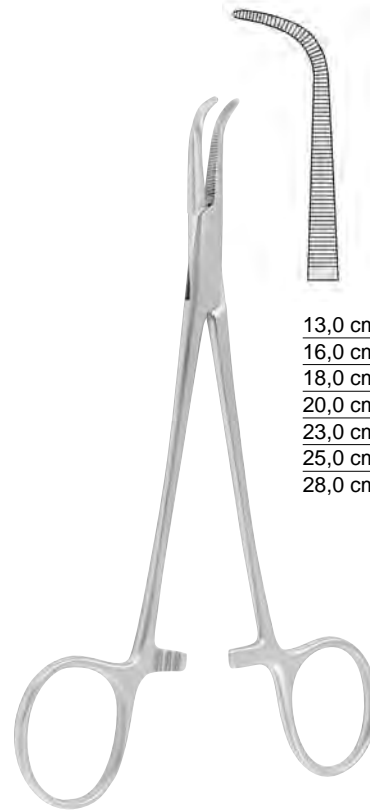


19,0 cm, 7 ¹ / ₂ "	112.463.19	112.465.19	112.467.19
22,0 cm, 8 ⁵ / ₈ "	112.463.22	112.465.22	112.467.22
24,0 cm, 9 ¹ / ₂ "	112.463.24	112.465.24	112.467.24



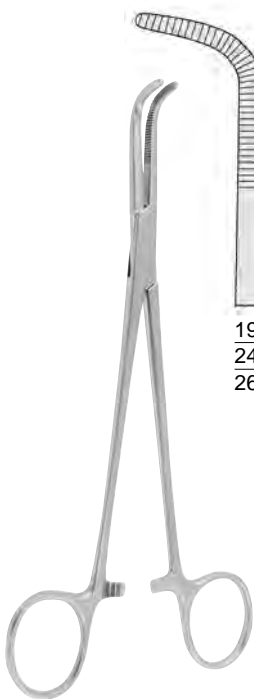
18,0 cm, 7"	112.433.18
22,0 cm, 8 ⁵ / ₈ "	112.433.22
25,0 cm, 9 ³ / ₄ "	112.433.25
28,0 cm, 11"	112.433.28

MINI-GEMINI



13,0 cm, 5 ¹ / ₂ "	112.431.14
16,0 cm, 6 ¹ / ₄ "	112.431.16
18,0 cm, 7"	112.431.18
20,0 cm, 8"	112.431.20
23,0 cm, 9"	112.431.23
25,0 cm, 9 ³ / ₄ "	112.431.25
28,0 cm, 11"	112.431.28

GEMINI



19,0 cm, 8"	112.461.20
24,0 cm, 9 ¹ / ₂ "	112.461.24
26,0 cm, 11"	112.461.28

KANTROWITZ



19,0 cm, 7 ¹ / ₂ "	112.478.19
21,0 cm, 8 ¹ / ₄ "	112.478.21
24,0 cm, 9 ¹ / ₂ "	112.478.24

WIKSTROEM



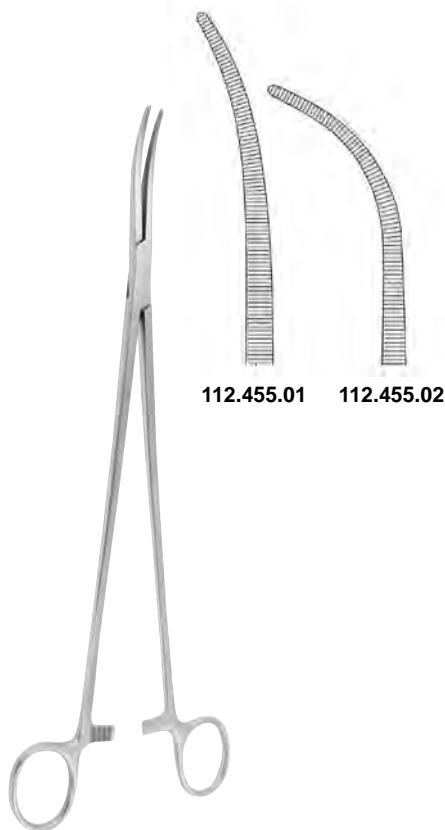
MIXTER
15,5 cm, 6" **112.471.16**
19,0 cm, 7½" **112.471.19**



MIXTER-O'SHAUGHNESSY
15,5 cm, 6" **112.477.15**
19,0 cm, 7½" **112.477.19**



MIXTER
22,0 cm, 8¾" **112.473.22**



ZENKER

112.455.01

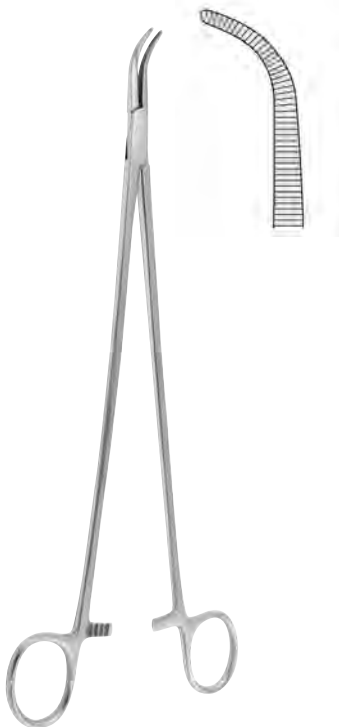
112.455.02



MEEKER

112.459.18

112.459.28



LAWRENCE
 28,0 cm, 11"
 112.457.28



DESJARDINS
 21,0 cm, 8 1/4"
 112.503.21



MIXTER
 22,0 cm, 8 3/4" **112.479.22**
 25,0 cm, 9 3/4" **112.479.25**
 28,0 cm, 11" **112.479.28**



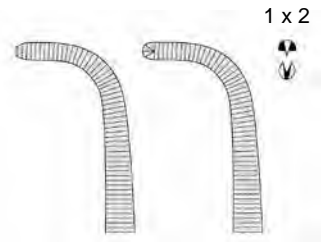
LAHEY
 19,0 cm, 7 1/2" **112.491.19**
 23,0 cm, 9" **112.493.23**



LOWER
 18,0 cm, 7"
 112.495.18



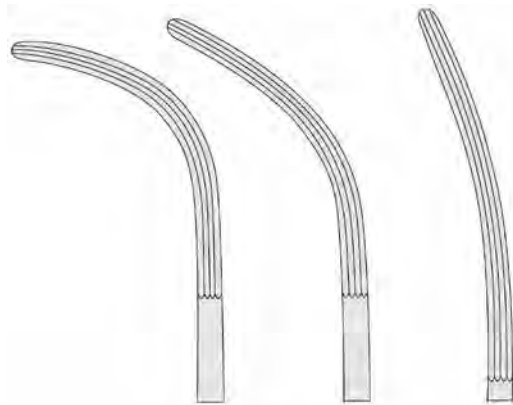
GRAY



22,0 cm, 8 ³ / ₄ "	112.507.22	112.509.22
23,0 cm, 9"	112.507.23	112.509.23



CRAFOORD-SELLORS



22,0 cm, 8 ³ / ₄ "	23,0 cm, 9"	24,0 cm, 9 ¹ / ₂ "
112.315.22	112.315.23	112.315.224



FINOCCHIETTO
24,0 cm, 9¹/₂"
156.307.24

Gallenkanal- und Nierenstielklemmen
 Gall Duct and Kidney Pedicle Clamps
 Pinzas-clamps para pedúnculo renal
 Pinze per peduncoli renali



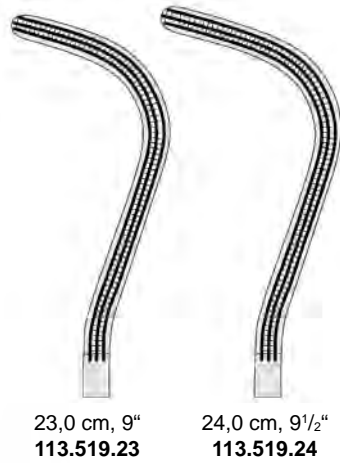
GUYON
 20,0 cm, 8" 112.519.20
 22,0 cm, 8³/₄" 112.519.22
 24,0 cm, 9¹/₂" 112.519.24



GUYON
 23,0 cm, 9"
 112.517.23



GUYON



23,0 cm, 9"
 113.519.23

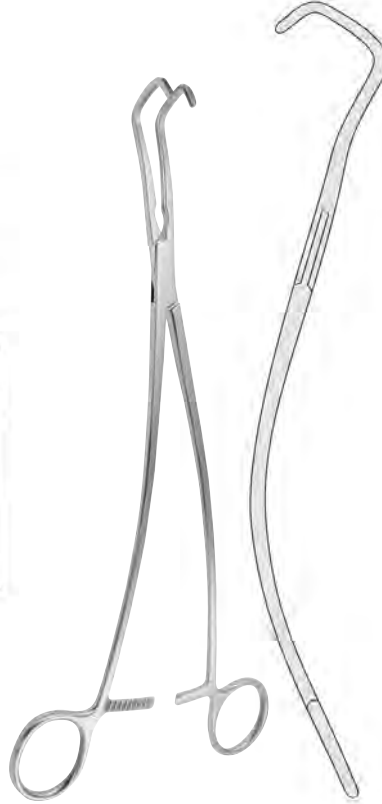
24,0 cm, 9¹/₂"
 113.519.24



STILLE
 23,0 cm, 9"
 112.516.23



HERRICK
23,0 cm, 9"
112.523.23



URO-TANGENTIAL

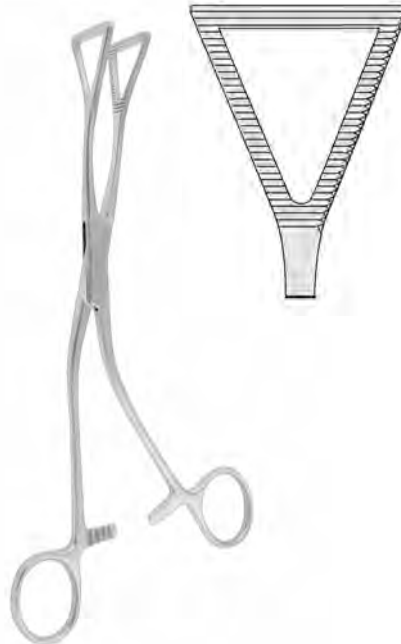


23,0 cm, 9"
113.261.23

24,0 cm, 9½"
113.261.24



LOVELACE
20,0 cm, 8"
126.290.20



LOVELACE
20,0 cm, 8"
126.291.20

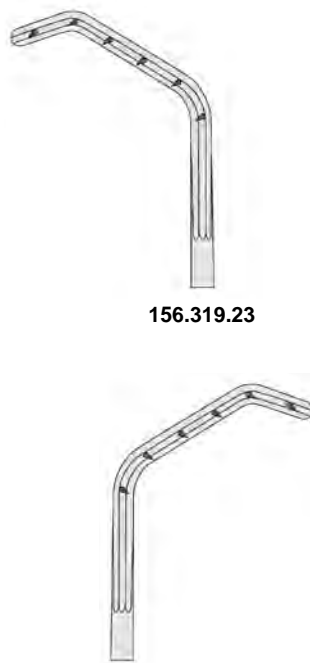


PRICE-THOMAS
22,0 cm, 8¾"
126.309.22

Bronchusklemmen, Peritoneumklemmen, Hysterektomieklemmen
 Bronchus Forceps, Peritoneum Forceps, Hysterectomy Forceps
 Pinzas-clamps para bronquios, Pinzas-clamps para peritoneo y para histerectomía
 Pinze per legature, Pinze per peritoneo e per isterectomia



PRICE-THOMAS
 23,0 cm, 8³/₄"

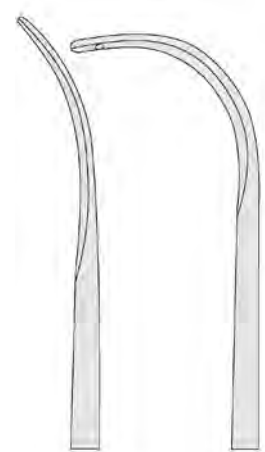


156.319.23

126.317.23



SEMB
 23,0 cm



126.321.23

126.323.23



BABY-MIKULICZ
 14,0 cm, 5¹/₂"
 112.550.14

1 x 2



MIKULICZ
 18,0 cm, 7"
 112.551.18

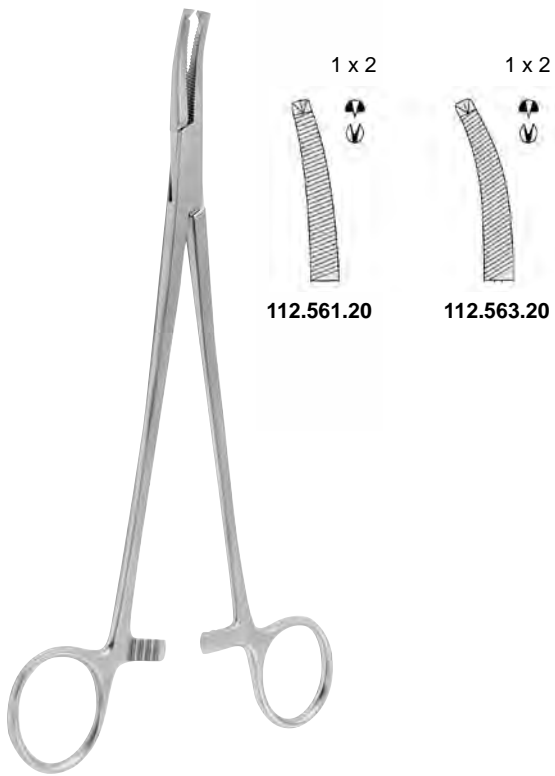
1 x 2



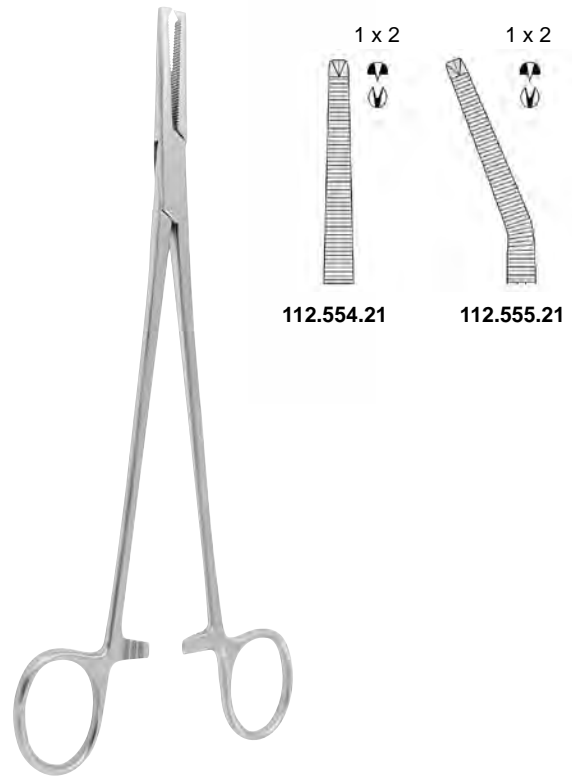
MIKULICZ
 20,0 cm, 8"
 112.553.20

1 x 2

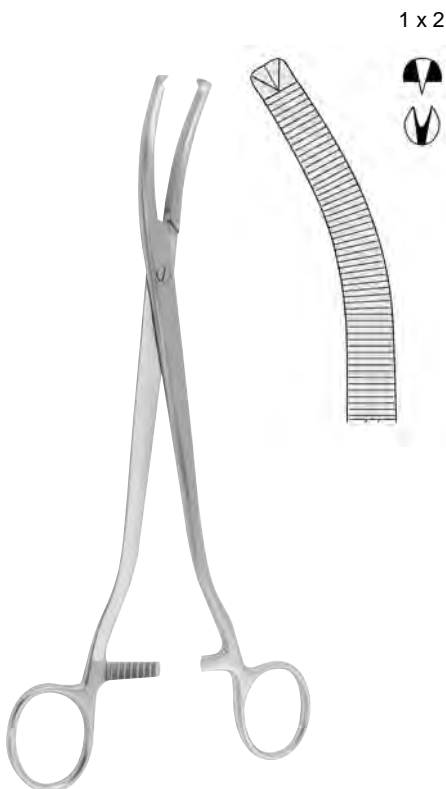




FAURE
20,0 cm, 8"



PHANEUF
21,5 cm, 8½"



WERTHEIM
24,0 cm, 9½"
112.553.24



WERTHEIM
25,0 cm, 10"
112.571.25

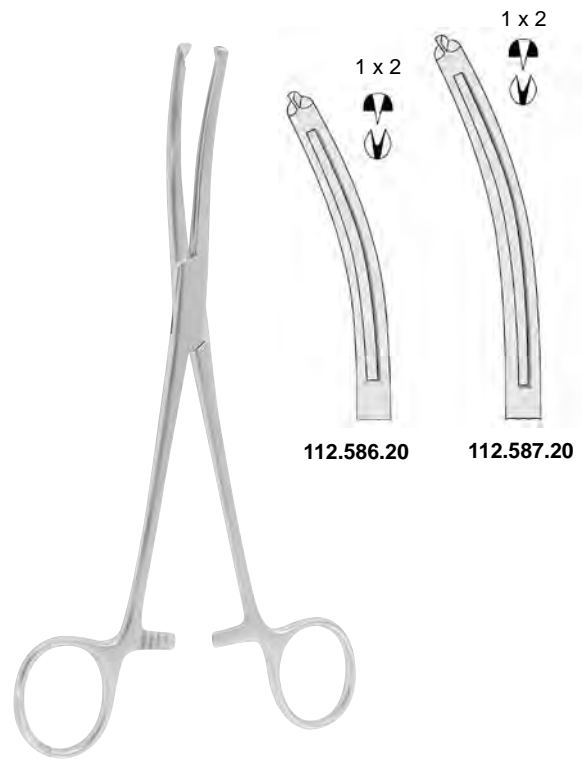
Hysterektomieklemmen
 Hysterectomy Forceps
 Pinzas-clamps para histerectomía
 Pinze per isterectomia



112.573.22

112.575.23

WERTHEIM
 23,0 cm, 9"



112.586.20

112.587.20

MAINGOT
 21,5 cm, 8 1/2"



23,0 cm, 9"
 112.501.23

24,0 cm, 9 1/2"
 112.501.24

MOYNIHAN



WERTHEIM-CULLEN
 21,5 cm, 8 1/2"
 112.579.21

1 x 2



LONG
19,0 cm, 7¹/₄"
112.601.19



HEANEY
21,0 cm, 8¹/₄"
112.591.20



112.594.20

112.595.20

HEANEY-BALLANTINE
21,0 cm, 8¹/₄"



HEANEY-KANTER
20,0 cm, 8¹/₄"
112.593.20

Hysterektomieklemmen
Hysterectomy Forceps
Pinzas-clamps para histerectomía
Pinze per isterectomia



Tuch-, Schlauchklemmen, Tupferzangen

Towel Clamps, Sponge and Dressing Forceps, Tubing Clamps

Pinzas de campo, Pinzas para vendajes y torundas y para tubos

Pinze per fissare le compresse, per medicatura e tamponi, e per tubi



SCHAEDEL
9,0 cm, 3 1/2"
114.101.09



ENGL. MODELL
9,0 cm, 3 1/2"
114.102.09



JONES
5,0 cm, 2" **114.103.05**
9,0 cm, 3 1/2" **114.103.09**



JONES
9,0 cm, 3 1/2"
114.105.09

mit Schlauch- oder Kabelhalter
with clip for tubing or cable
con porta-tubo o porta-cable
con porta-tubo o porta-cavo



BACKHAUS
9,0 cm, 3 1/2" **114.111.09**
11,0 cm, 4 3/8" **114.111.11**
13,0 cm, 5" **114.111.13**
15,0 cm, 6" **114.111.15**



11,0 cm, 4 3/8"
114.115.11



ROEDER
13,0 cm, 5"
114.117.13

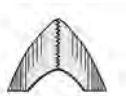


BERNHARD
16,5 cm, 6½"
114.140.16



Kugel / Pfanne
Ball / Socket
Bola / Cojinete
Palla / Cuscinetto

8,0 cm 114.123.08
11,0 cm 114.123.11
13,0 cm 114.123.13



10,0 cm, 4"
114.121.10



11,0 cm, 4¾"
114.121.11



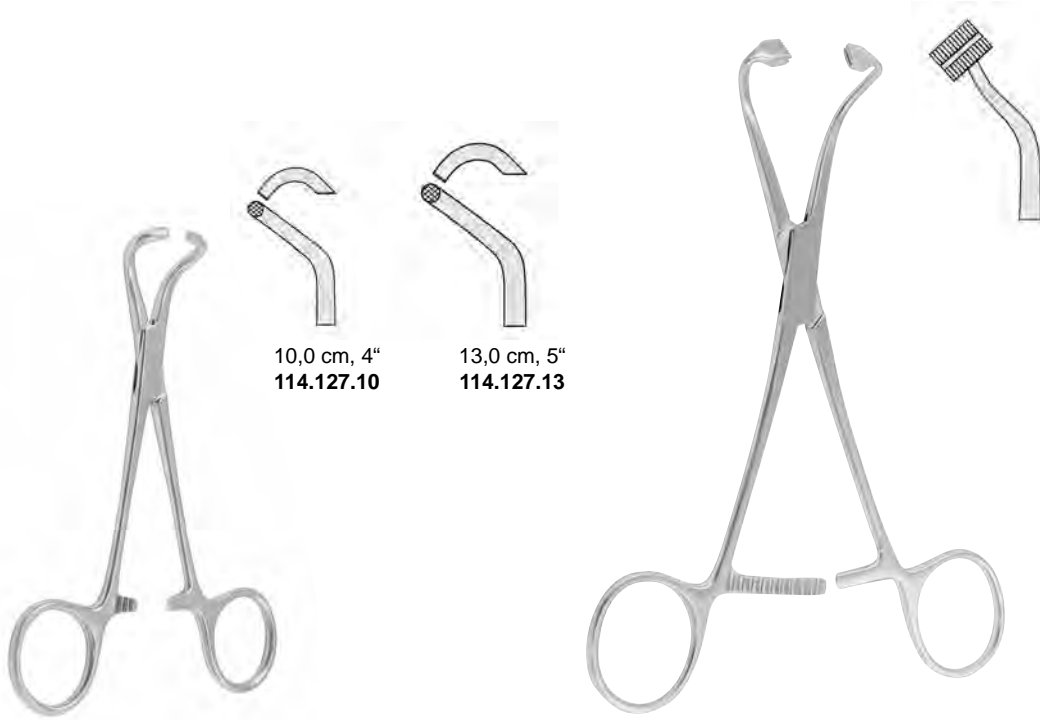
13,0 cm, 5"
114.121.13



LORNA



LANE
15,0 cm, 6" 114.164.15
18,0 cm, 7" 114.164.18
20,0 cm, 8" 114.164.20



10,0 cm, 4"
 114.127.10

13,0 cm, 5"
 114.127.13

TOHOKU

PEERS
 14,5 cm, 5³/₄"
 114.165.14



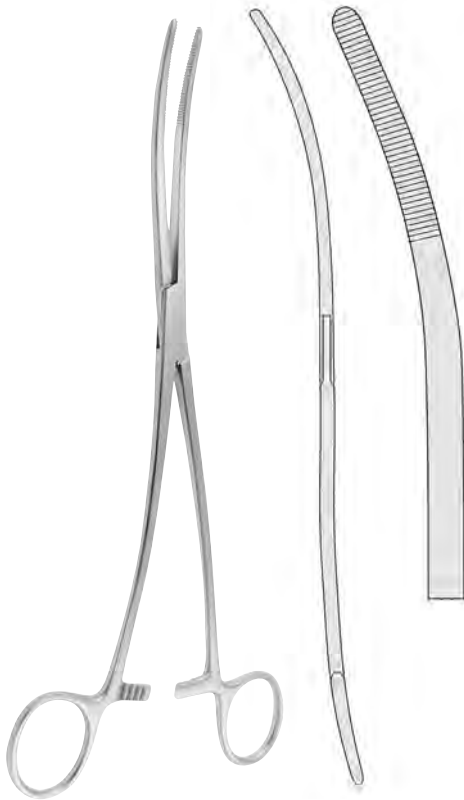
LISTER
 13,0 cm, 5" 116.210.13
 16,0 cm, 6¹/₄" 116.210.16
 18,0 cm, 7" 116.210.18



BRYANT
 13,0 cm, 5"
 116.207.13



BOZEMANN
 26,0 cm, 10¹/₄"
 116.230.26



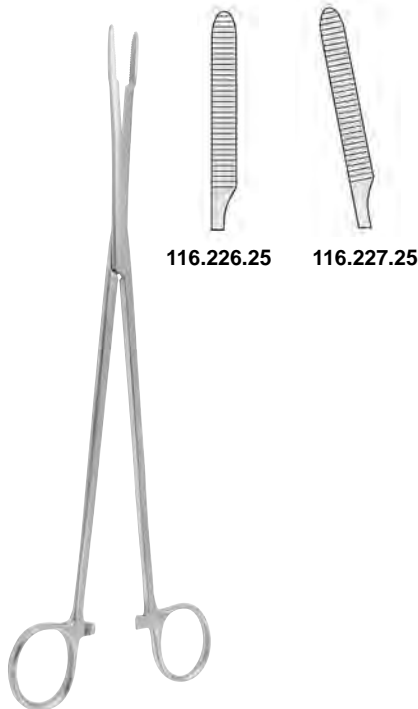
BOZEMANN
26,0 cm, 10¹/₄"
116.231.26



COLLIN
25,0 cm, 9³/₄"
116.220.25



CHERON
25,0 cm, 9³/₄"
116.229.25



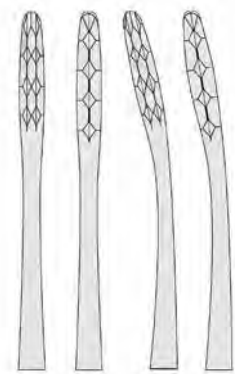
PELKMANN
25,0 cm, 9³/₄"

116.226.25

116.227.25



ULRICH

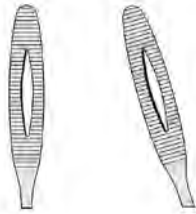


22,0 cm, 8 ⁵ / ₈ "	116.160.22	116.161.22
25,0 cm, 9 ³ / ₄ "	116.160.25	116.161.25
27,0 cm, 10 ⁵ / ₈ "	116.160.27	116.161.27



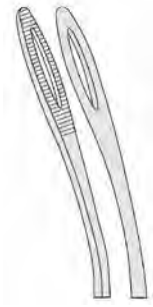
GROSS-MAIER

20,0 cm, 8"	116.110.20	116.111.20
22,0 cm, 8 ⁵ / ₈ "	116.110.22	116.111.22
25,0 cm, 9 ³ / ₄ "	116.110.25	116.111.25
27,0 cm, 10 ⁵ / ₈ "	116.110.27	116.111.27



FOERSTER

25,0 cm, 9 ³ / ₄ "	116.174.25
--	-------------------



25,0 cm, 9 ³ / ₄ "	116.175.25
--	-------------------



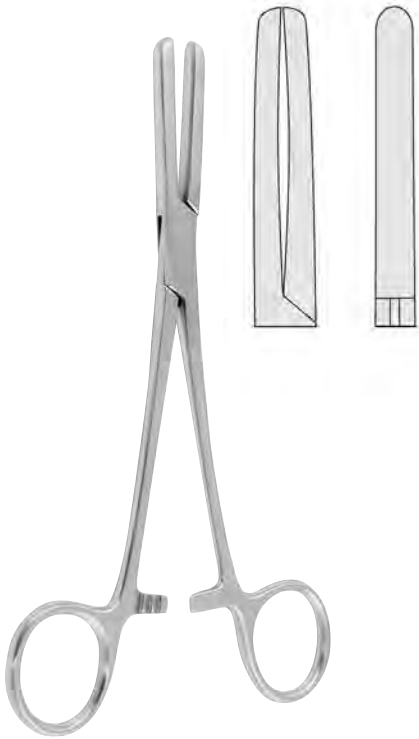
FOERSTER-BALLEGER

18,0 cm, 7"	116.170.18	116.171.18	116.172.18	116.173.18
20,0 cm, 8"	116.170.20	116.171.20	116.172.20	116.173.20
25,0 cm, 9 ³ / ₄ "	116.170.25	116.171.25	116.172.25	116.173.25



RAMPLEY

18,0 cm, 7"	116.180.18
25,0 cm, 9 ³ / ₄ "	116.180.25



PRESBYTERIAN

16,5 cm, 6½"	112.704.16
18,5 cm, 7"	112.704.18
20,0 cm, 8"	112.704.20



BERLIN

14,5 cm, 5¾"	112.702.14
--------------	-------------------



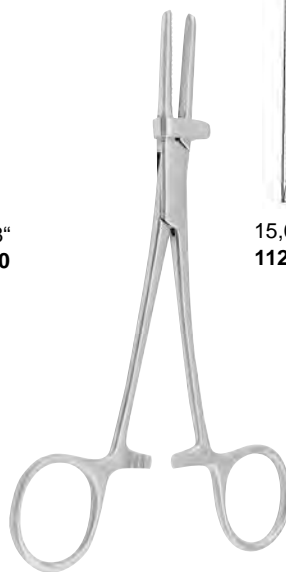
15,0 cm, 6"
112.710.15



18,0 cm, 7"
112.710.18



20,0 cm, 8"
112.710.20



15,0 cm, 6"
112.712.15



18,0 cm, 7"
112.712.18



20,0 cm, 8"
112.712.20

Wundhaken
Retractors
Separadores
Divaricatori

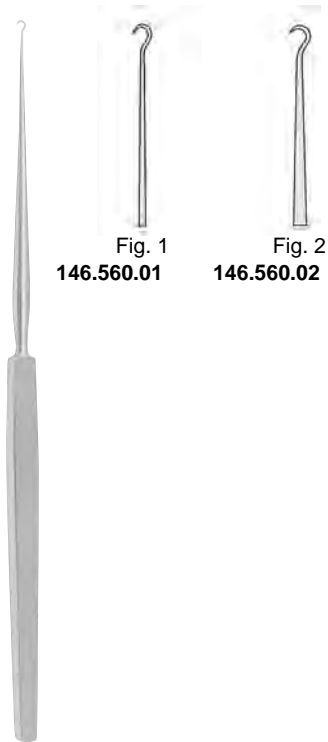


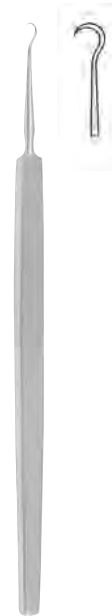
Fig. 1
146.560.01

Fig. 2
146.560.02

GILLIES
 18,0 cm, 7"



KILNER
 15,0 cm, 6"
174.103.15



FRAZIER
 13,0 cm, 5"
118.214.13

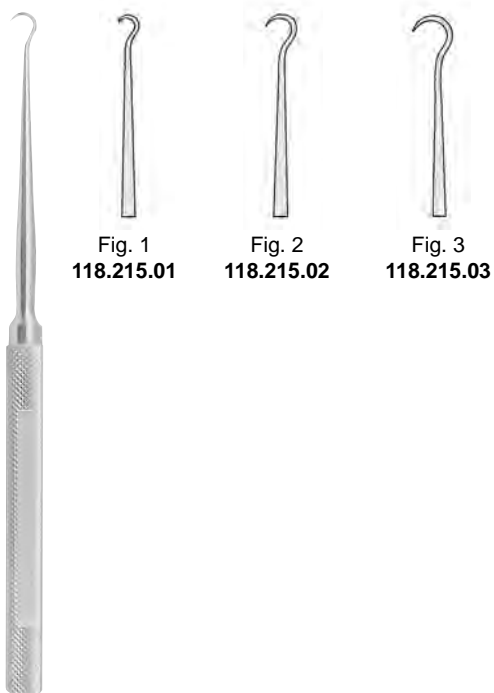


Fig. 1
118.215.01

Fig. 2
118.215.02

Fig. 3
118.215.03

KLEINERT-KUTZ
 16,0 cm, 6 1/4"



JOSEPH
 16,0 cm, 6 1/4"
118.216.01

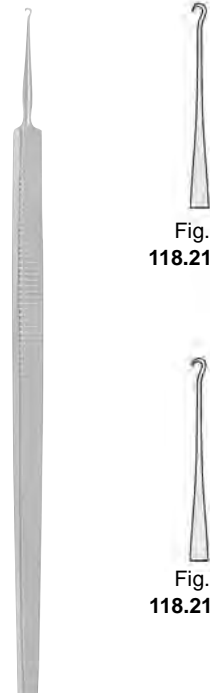


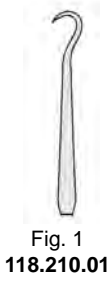
Fig. 1
118.210.12

Fig. 2
118.211.12

GRAEFE
 12,5 cm, 6 1/4"



16,0 cm, 6 1/4"



GUTHRIE
16,0 cm, 6 1/4"



JOSEPH
16,0 cm, 6 1/4"





Fig. 1
142.279.13

scharf
sharp
agudos
acuti

KNAPP
13,0 cm, 5"



Fig. 2
142.377.13

stumpf
blunt
romo
smusso



16,0 cm, 6 1/4"



118.226.02



118.226.02



118.226.03



118.226.03



118.226.04



118.226.04

flexibel · flexible · flexibles · flessibili



118.220.01



118.223.01



118.221.01



118.220.02



118.223.02



118.221.02



118.220.03



118.223.03



118.221.03



118.220.04



118.223.04



118.221.04

scharf
sharp
agudos
acuti

halbscharf
semi-sharp
semi-agudos
semi-acuti

stumpf
blunt
romo
smusso

16,0 cm, 6 1/4"



CUSHING
19,0 cm, 7 1/2"



Fig. 1
140.056.19



Fig. 2
140.058.19



LANGENBECK-GREEN
16,0 cm, 6 1/4"



16 x 6 mm
118.246.16



24 x 6 mm
118.246.24



18 x 7 mm
118.302.01



16 x 5 mm
118.302.02



7 x 4 mm
118.302.03



10 x 3 mm
118.302.04



7 x 4 mm
118.302.05



4 x 10 mm
118.302.06

MEYERDING
18,0 cm, 7"



10 x 6 mm
118.240.10



20 x 6 mm
118.210.20

SENN-GREEN
15,0 cm, 6"



10 x 6 mm
118.247.10



17 x 5 mm
118.247.17



20 x 6 mm
118.247.20

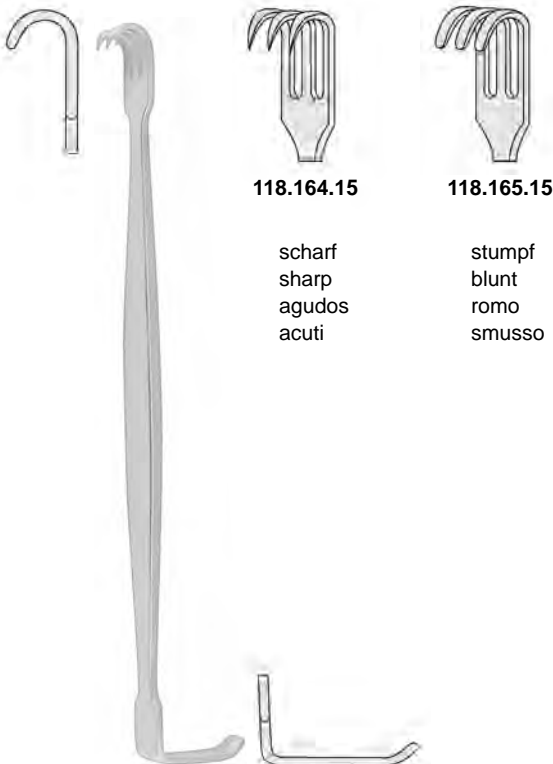


22 x 8 mm
118.247.22

MINI-LANGENBECK
16,0 cm, 6 1/4"



RAGNELL-DAVIS
14,0 cm, 5½"
118.242.14



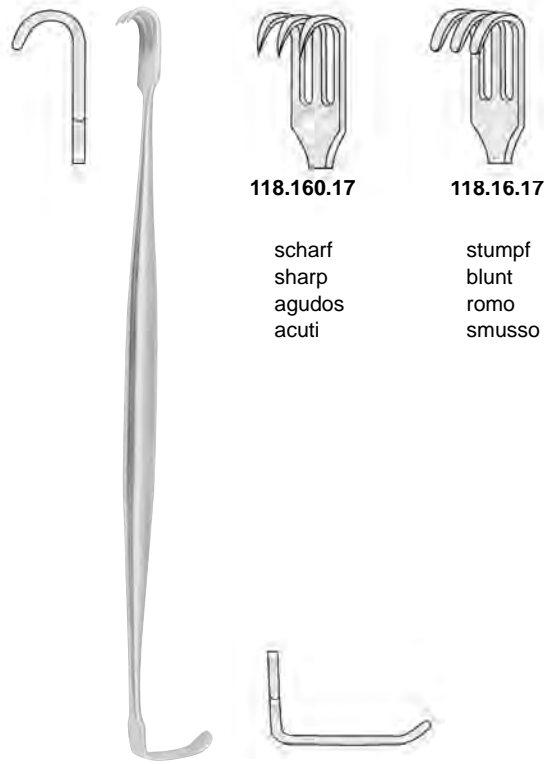
BABY SENN-MILLER
15,0 cm, 6"

118.164.15

scharf
sharp
agudos
acuti

118.165.15

stumpf
blunt
romo
smusso



SENN-MILLER
16,0 cm, 6¼"

118.160.17

scharf
sharp
agudos
acuti

118.16.17

stumpf
blunt
romo
smusso



8 mm
118.231.08



10 mm
118.231.10



12 mm
118.231.12



14 mm
118.231.14



16 mm
118.231.16

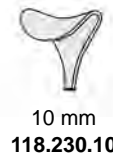


18 mm
118.231.18

DESMARRES
13,0 cm, 5"



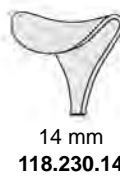
8 mm
118.230.08



10 mm
118.230.10



12 mm
118.230.12



14 mm
118.230.14



16 mm
118.230.16



18 mm
118.230.18

DESMARRES
16,0 cm, 6 1/4"



CUSHING
20,0 cm, 8"



8 mm
118.232.08



10 mm
118.232.10



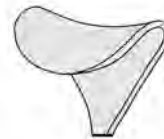
12 mm
118.232.12



14 mm
118.232.14



16 mm
118.232.16



18 mm
118.232.18



CUSHING
24,0 cm, 9½"



8 mm
118.233.08



10 mm
118.233.10



12 mm
118.233.12



14 mm
118.233.14



16 mm
118.233.16



18 mm
118.233.18



8 mm
118.266.08



11 mm
118.266.11



13 mm
118.266.13



17 mm
118.266.17



19 mm
118.266.20

GIL-VERNET
24,0 cm, 9 1/2"



8 mm
118.265.08



11 mm
118.265.11



13 mm
118.265.13



15 mm
118.265.17



19 mm
118.265.20

GIL-VERNET
22,0 cm, 9 1/2"
biegsam



ROUX
118.120.00

Fig. 1 24 x 20 mm
Fig. 2 29 x 26 mm
Fig. 3 33 x 29 mm

Satz, Fig. 1-3
Set, fig. 1-3
Juego, fig. 1-3
Serie, fig. 1-3

Fig. 1 30 x 28 mm
Fig. 2 36 x 36 mm
Fig. 3 38 x 43 mm

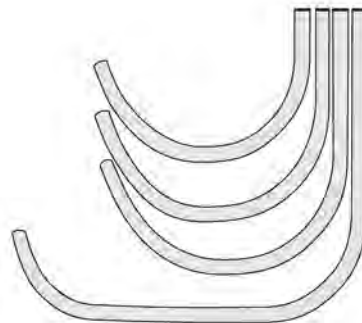
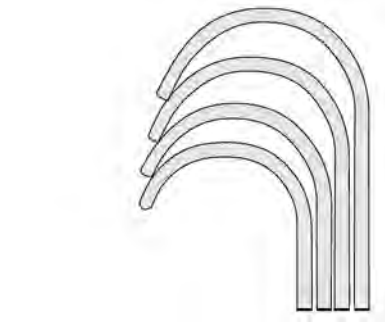


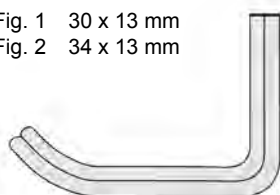
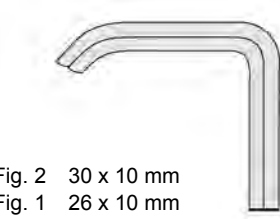
Fig. 1-3	17,0 cm, 6 ³ / ₄ "	118.120.00
Fig. 1	14,0 cm, 5 ¹ / ₂ "	118.120.01
Fig. 2	15,0 cm, 6"	118.120.02
Fig. 3	17,0 cm, 6 ³ / ₄ "	118.120.03



FARABEUF
12,0 cm, 4³/₄"
118.102.12

Fig. 2 30 x 10 mm
Fig. 1 26 x 10 mm

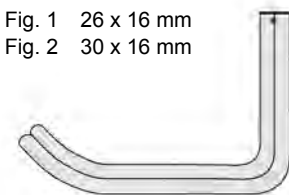
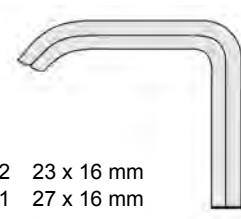
Fig. 1 30 x 13 mm
Fig. 2 34 x 13 mm



FARABEUF
15,0 cm, 5³/₄"
118.102.15

Fig. 2 23 x 16 mm
Fig. 1 27 x 16 mm

Fig. 1 26 x 16 mm
Fig. 2 30 x 16 mm





MINI-ROUX
14,0 cm, 5½"
118.124.15



BABY-ROUX
13,0 cm, 5"
118.122.13



PARKER
13,5 cm, 5¾"
118.110.13

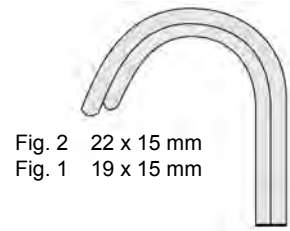


Fig. 2 22 x 15 mm
Fig. 1 19 x 15 mm

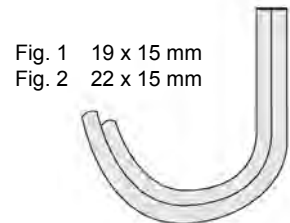
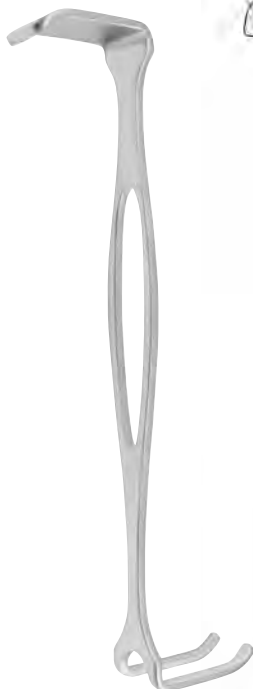


Fig. 1 19 x 15 mm
Fig. 2 22 x 15 mm



CZERNY
17,5 cm, 7"
118.136.20



MATHIEU
20,0 cm, 8"
118.134.20

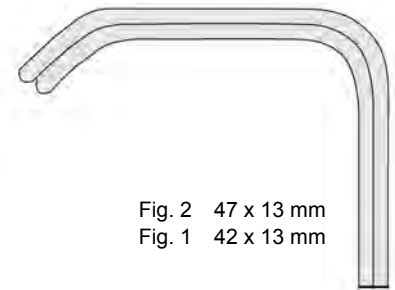


Fig. 2 47 x 13 mm
Fig. 1 42 x 13 mm

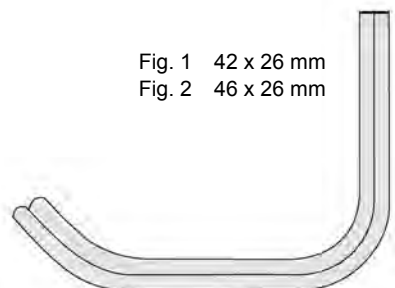


Fig. 1 42 x 26 mm
Fig. 2 46 x 26 mm



GOELET
19,0 cm, 7¹/₂"
118.135.19

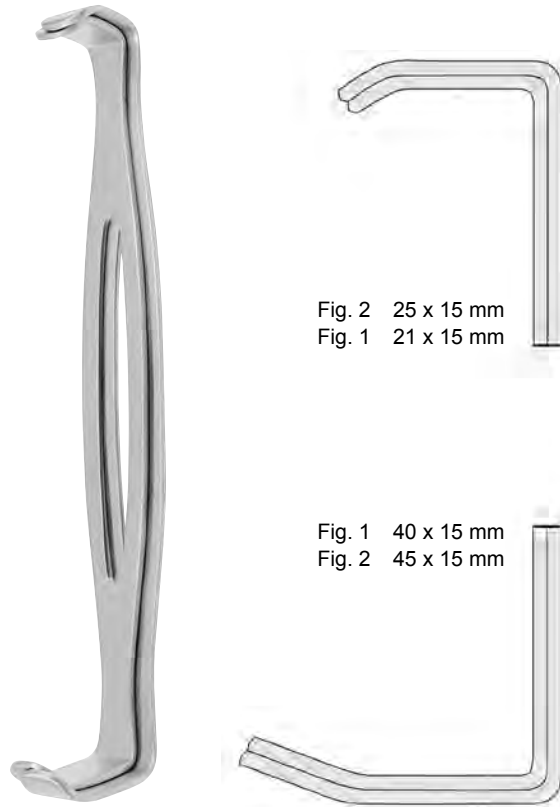


Fig. 2 25 x 15 mm
Fig. 1 21 x 15 mm

Fig. 1 40 x 15 mm
Fig. 2 45 x 15 mm

PARKER-LANGENBECK
21,0 cm, 8¹/₄"
118.131.21



VOLKMANN
 21,5 cm, 8 1/2"



118.280.01



118.280.02



118.280.03



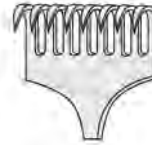
scharf
 sharp
 agudos
 acuti



118.280.04



118.280.06



118.280.08



VOLKMANN
 21,5 cm, 8 1/2"



118.279.01



118.279.02



118.279.03



halbscharf
 semi-sharp
 semi-agudos
 semi-acuti



118.279.04



118.279.06



118.279.08



VOLKMANN
21,5 cm, 8½"



118.281.01



118.281.02



118.281.03



118.281.04



118.281.06



118.281.08

stumpf
blunt
romo
smusso



KOCHER
22,0 cm, 8⅝"



118.333.01



118.333.02



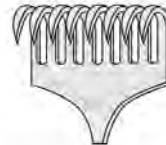
118.333.03



118.333.04



118.333.06



118.333.08

scharf
sharp
agudos
acuti

Wundhaken
Retractors
Separadores
Divaricatori



118.334.01



118.334.02



118.334.03



118.334.04



118.334.06



118.334.08

halbscharf
semi-sharp
semi-agudos
semi-acuti

KOCHER
22,0 cm, 8⁵/₈"



118.335.01



118.335.02



118.335.03



118.335.04



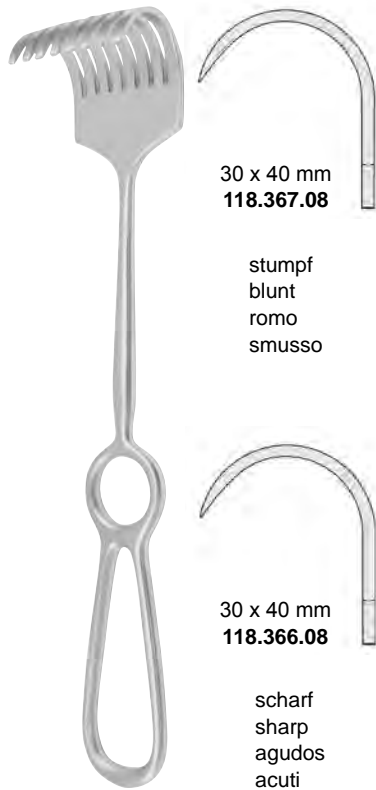
118.335.06



118.335.08

stumpf
blunt
romo
smusso

KOCHER
22,0 cm, 8⁵/₈"



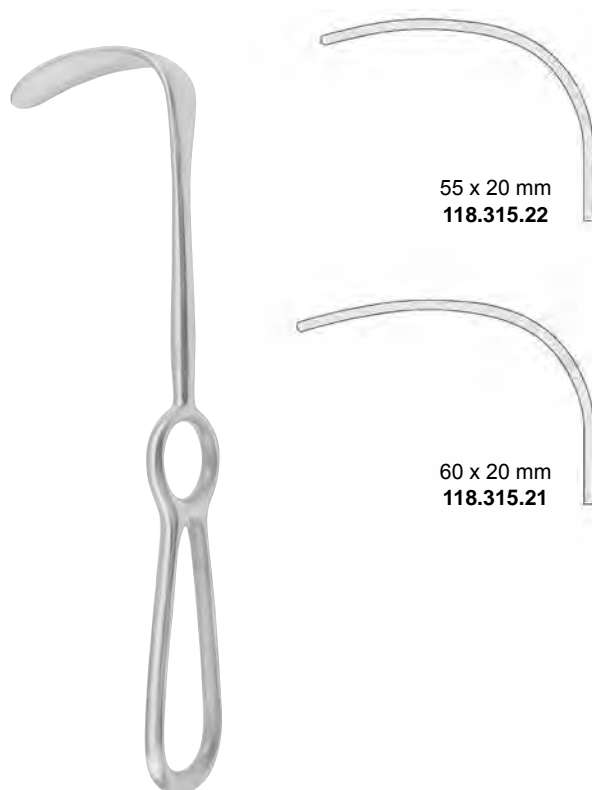
30 x 40 mm
118.367.08

stumpf
blunt
romo
smusso

30 x 40 mm
118.366.08

scharf
sharp
agudos
acuti

KOERTE
24,0 cm, 9½"



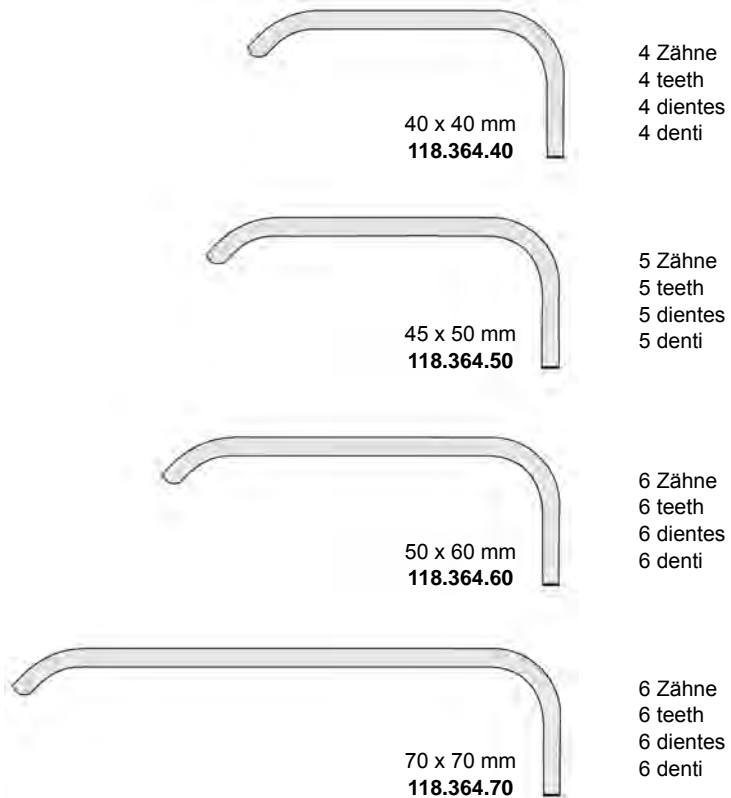
55 x 20 mm
118.315.22

60 x 20 mm
118.315.21

LANGENBECK
21,0 cm, 8¼"



ISRAEL
25,0 cm, 9¾"



40 x 40 mm
118.364.40

4 Zähne
4 teeth
4 dientes
4 denti

45 x 50 mm
118.364.50

5 Zähne
5 teeth
5 dientes
5 denti

50 x 60 mm
118.364.60

6 Zähne
6 teeth
6 dientes
6 denti

70 x 70 mm
118.364.70

6 Zähne
6 teeth
6 dientes
6 denti



LANGENBECK
22,0 cm, 8⁵/₈"



30 x 11 mm
118.310.01



30 x 14 mm
118.310.02



30 x 16 mm
118.310.03



40 x 11 mm
118.310.04



50 x 11 mm
118.310.05



LANGENBECK
22,0 cm, 8⁵/₈"



30 x 11 mm
118.312.01



30 x 14 mm
118.312.02



30 x 16 mm
118.312.03



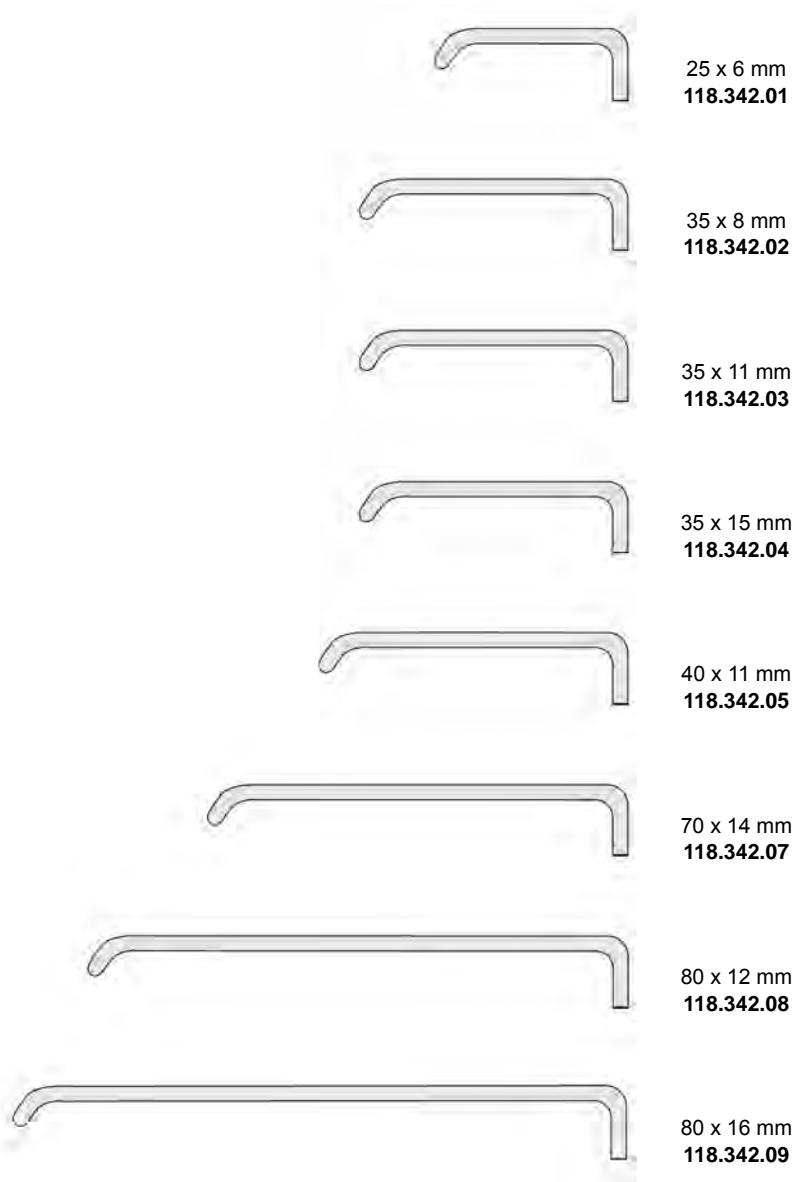
40 x 11 mm
118.312.04



50 x 11 mm
118.312.05



KOCHER-LANGENBECK
21,0 cm, 8 1/2"





KOCHER
23,0 cm, 9"



40 x 18 mm
118.318.40



60 x 20 mm
118.318.60



60 x 25 mm
118.318.61



75 x 30 mm
118.318.75



75 x 40 mm
118.318.78



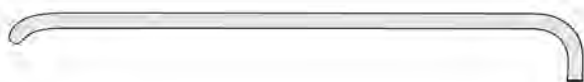
SAUERBRUCH
22,5 cm, 8³/₄"



45 x 15 mm
118.494.45



55 x 22 mm
118.494.60



72 x 19 mm
118.494.75



MIDDELDORPF



21,5 cm, 8¹/₂"
14 x 17 mm
118.344.14



22,0 cm, 8⁵/₈"
20 x 22 mm
118.344.20



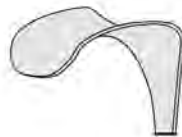
23,5 cm, 9¹/₄"
26 x 30 mm
118.344.26



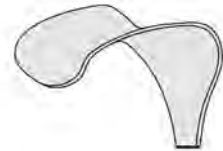
RICHARDSON (KELLY)
24,0 cm, 9¹/₂"



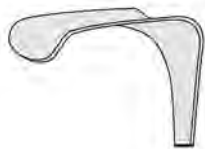
28 x 20 mm
118.150.01



36 x 28 mm
118.150.02



44 x 38 mm
118.150.03



52 x 22 mm
118.150.04

Wundhaken
Retractors
Separadores
Divaricatori

49 x 38 mm

28 x 20 mm

Fig. 2

Fig. 1

Fig. 1+2	28,0 cm, 11"	118.140.00
Fig. 1	26,0 cm, 10 ¹ / ₄ "	118.140.01
Fig. 2	28,0 cm, 11"	118.140.02

36 x 28 mm

63 x 49 mm

RICHARDSON-EASTMAN



MIDDELDORPF

25,5 cm, 10"



40 x 45 mm	118.141.01
45 x 50 mm	118.141.02
55 x 70 mm	118.141.03



FRITSCH
24,0 cm, 9¹/₂"

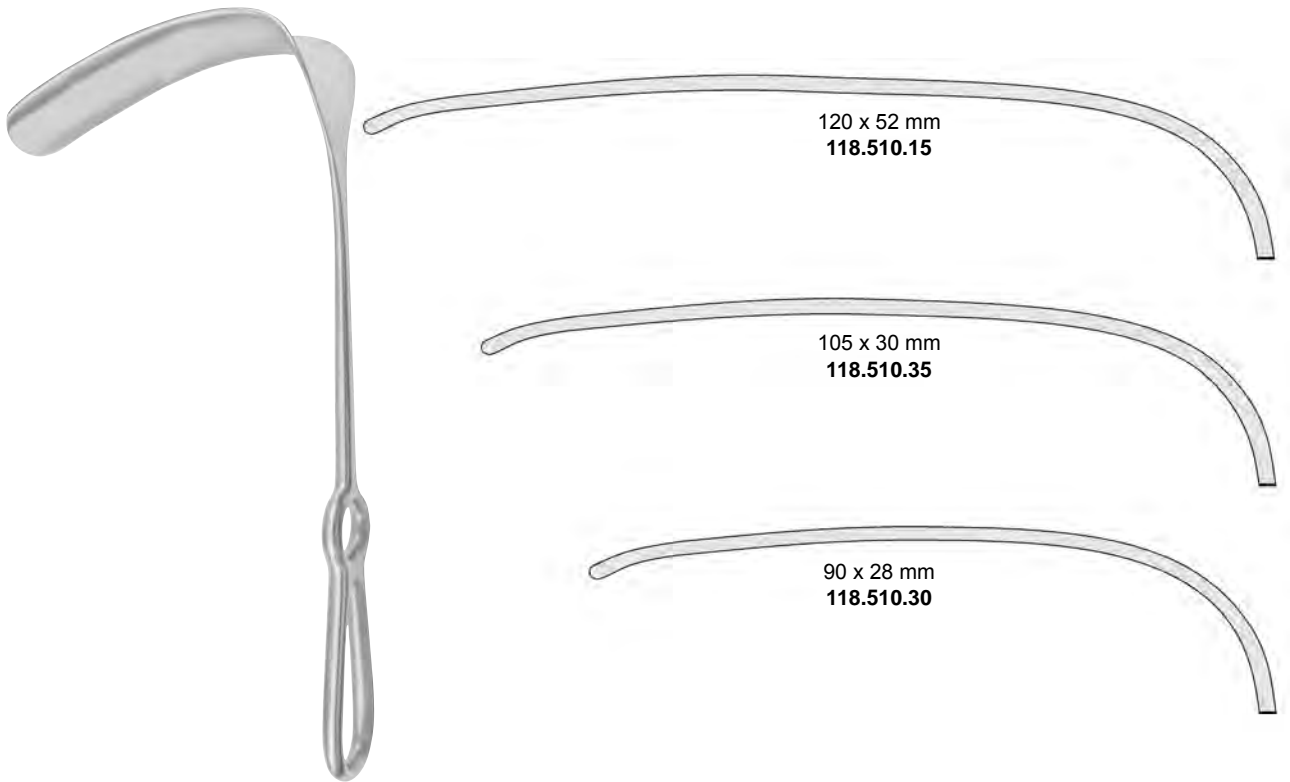


45 x 40 mm	118.370.40
45 x 50 mm	118.370.50
45 x 60 mm	118.370.60
45 x 75 mm	118.370.75
65 x 85 mm	118.370.85

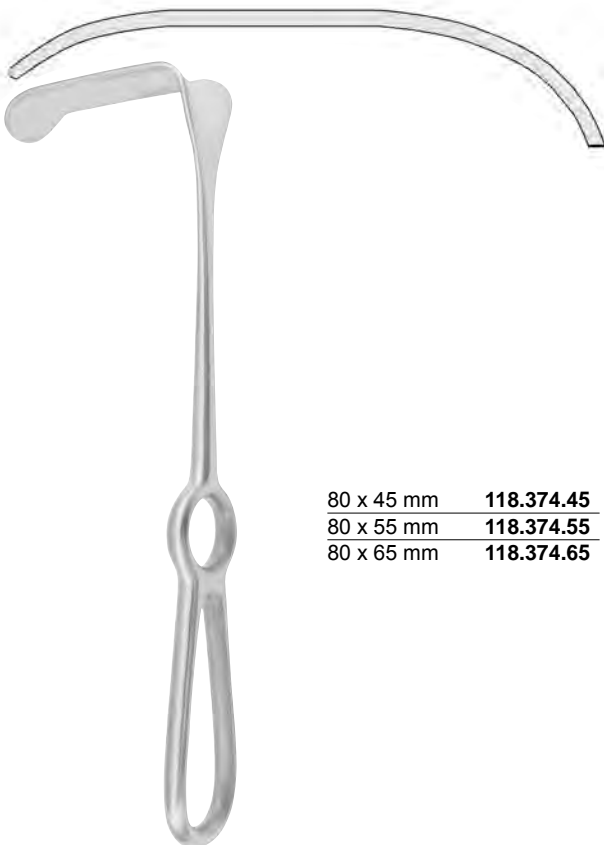


50 x 85 mm

DOYEN
25,0 cm, 10"
118.378.25



DOYEN-STILLE
22,0 cm, 8⁵/₈"



KOCHER
25,0 cm, 10"

LAHEY
19,0 cm, 7¹/₂"
18.304.19



12 x 14 mm

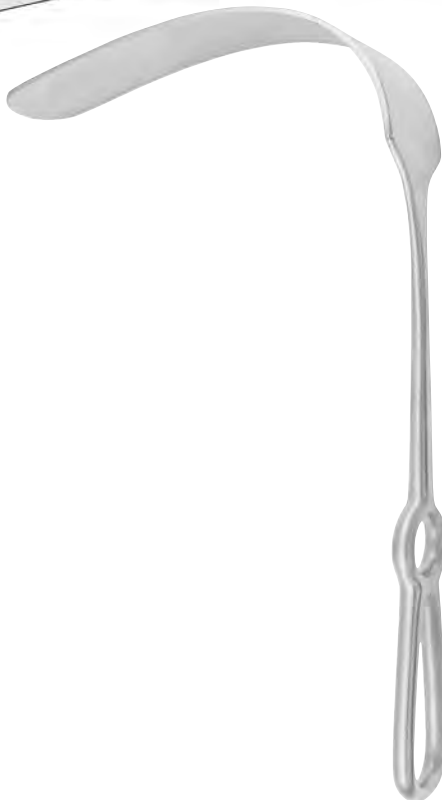
LITTLE
20,0 cm, 8"
118.306.20



SIMON

28,0 cm, 11"

115 x 22 mm	118.480.22
115 x 27 mm	118.480.27



160 x 38 mm	118.385.38
160 x 57 mm	118.385.57
190 x 38 mm	118.386.38
190 x 57 mm	118.386.57

KELLY
27,0 cm, 10½"



95 x 35 mm	118.380.35
120 x 50 mm	118.380.50
150 x 50 mm	118.381.50

MIKULICZ
26,0 cm, 10¹/₄"



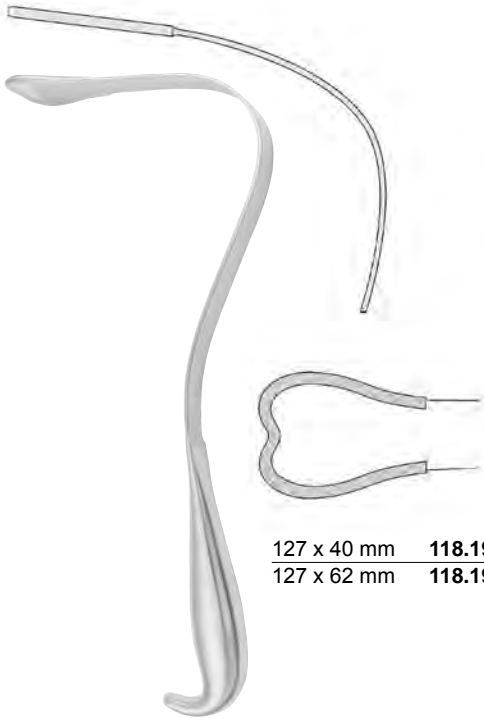
90 x 50 mm

MIKULICZ
26,0 cm, 10¹/₄"
118.382.50



70 x 38 mm	118.388.40
70 x 50 mm	118.388.50

MORRIS
24,5 cm, 9⁵/₈"



127 x 40 mm **118.191.40**
127 x 62 mm **118.191.62**

HARRINGTON
32,0 cm, 12½"

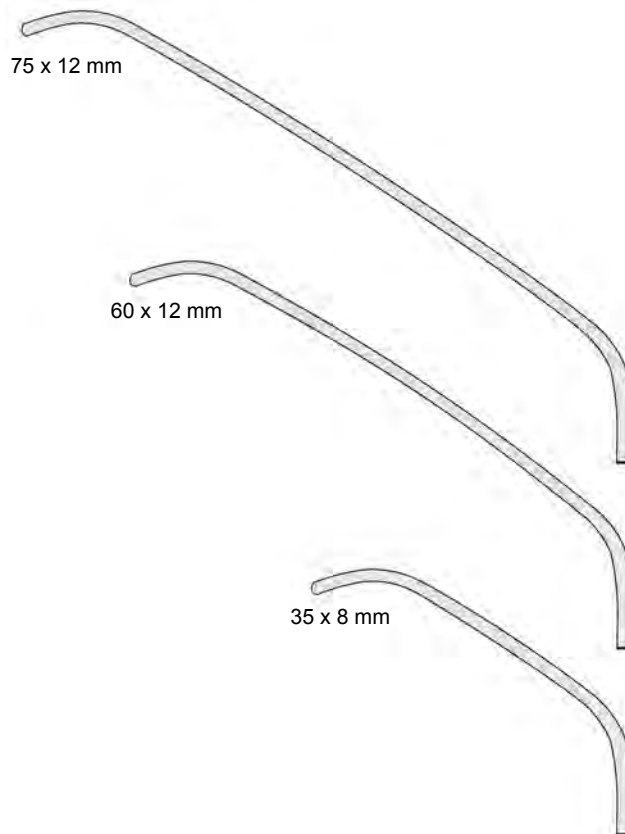


82 x 22 mm **118.490.22**
108 x 43 mm **118.490.43**
115 x 65 mm **118.490.65**

CORYLLOS
24,0 cm, 9½"



ZENKER



75 x 12 mm

60 x 12 mm

35 x 8 mm

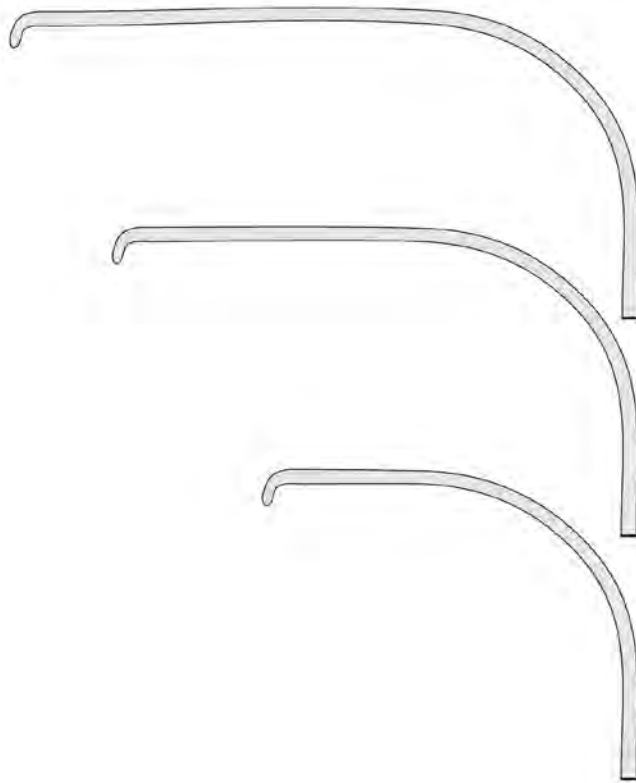
25,0 cm, 9¾"
118.343.75

26,0 cm, 10¼"
118.343.60

27,5 cm, 10¾"
118.343.35



MEYERDING
22,5 cm, 8³/₄"



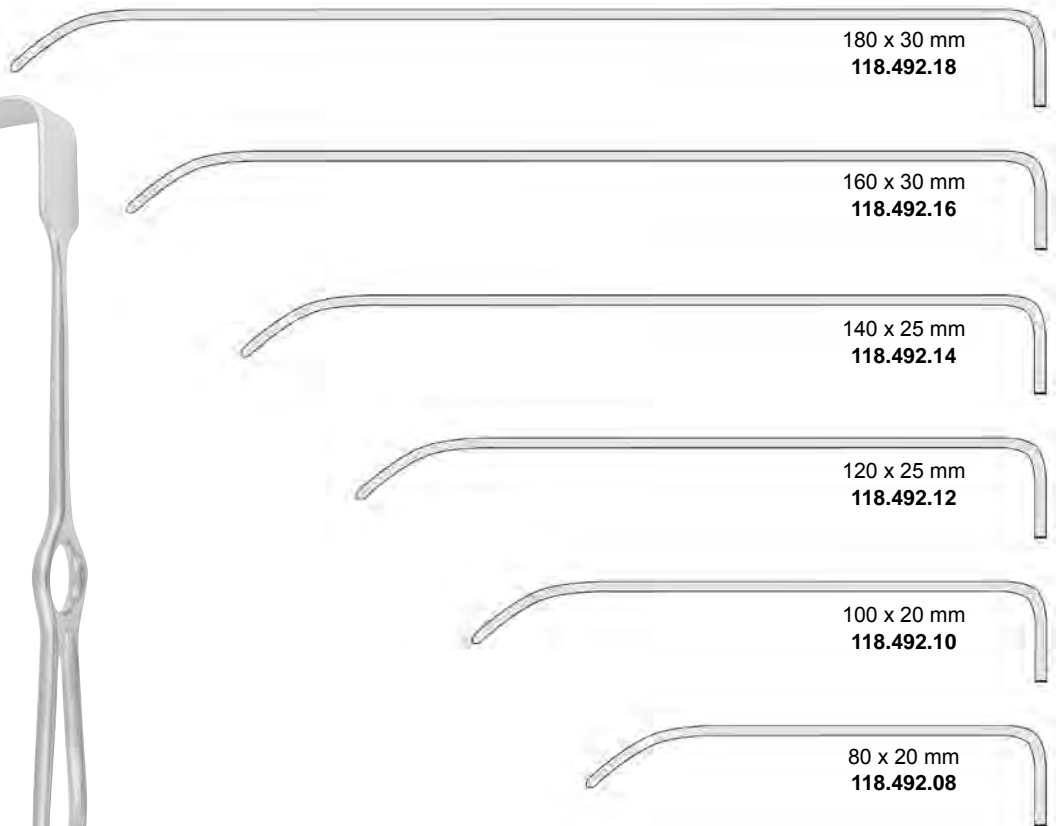
90 x 50 mm
118.498.03

75 x 25 mm
118.498.02

50 x 16 mm
118.498.01



BRUNNER
25,0 cm, 10"



180 x 30 mm
118.492.18

160 x 30 mm
118.492.16

140 x 25 mm
118.492.14

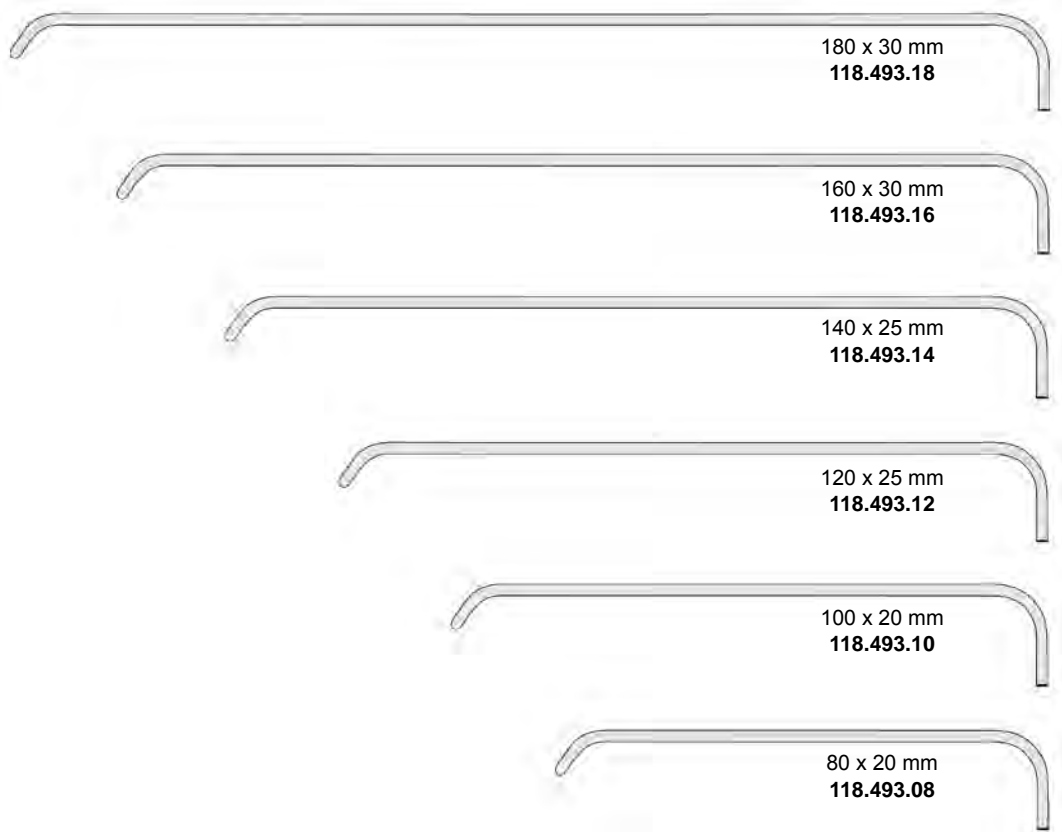
120 x 25 mm
118.492.12

100 x 20 mm
118.492.10

80 x 20 mm
118.492.08



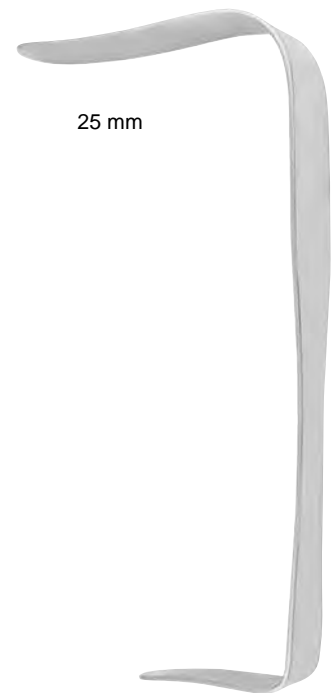
BRUNNER
 25,0 cm, 10"



DEAVER
 18,0 cm, 7"
118.180.19



DEAVER
 21,5 cm, 8¹/₂"
118.181.22



DEAVER
 23,0 cm, 9"
118.181.25

25 mm



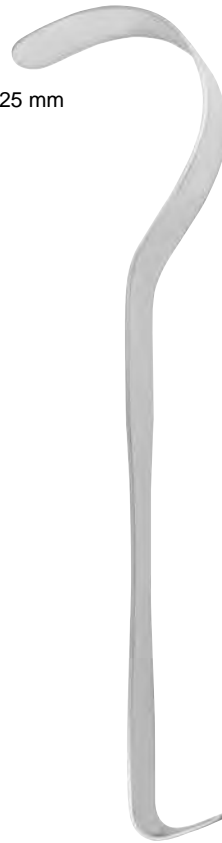
DEAVER
30,0 cm, 11³/₄"
118.183.25

25 mm



DEAVER
33,0 cm, 13"
118.185.25

25 mm



DEAVER
36,0 cm, 14¹/₈"
118.187.25

38 mm



DEAVER
30,0 cm, 11³/₄"
118.187.38

50 mm



DEAVER
30,0 cm, 11³/₄"
118.187.50

75 mm



DEAVER
30,0 cm, 11³/₄"
118.187.75



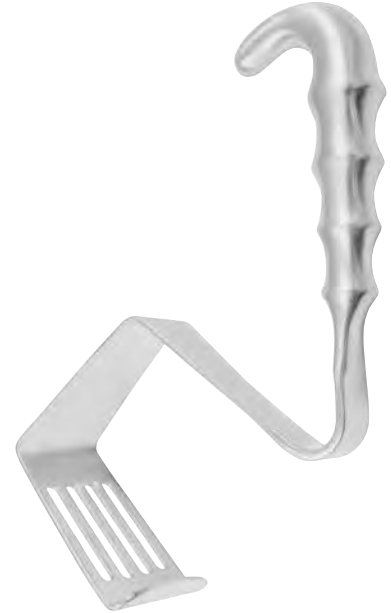
25 mm	118.189.25
38 mm	118.189.38
50 mm	118.189.50
75 mm	118.189.75

DEAVER
30,0 cm, 11³/₄"



40 mm	30,0 cm, 11 ³ / ₄ "	156.289.30
54 mm	32,0 cm, 12 ¹ / ₂ "	156.289.32

ALLISON

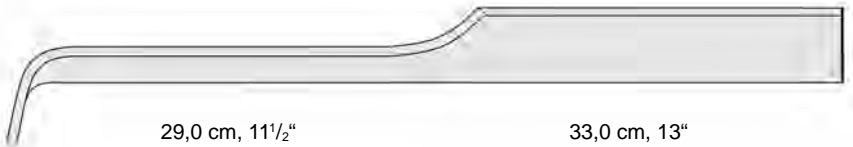


75 x 50 mm	16,0 cm, 6 ¹ / ₄ "	118.496.50
75 x 90 mm	16,0 cm, 6 ¹ / ₄ "	118.496.90

DAVIDSON



ST MARKS



29,0 cm, 11 ¹ / ₂ "	
130 x 60 mm	
118.387.01	

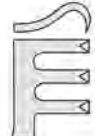

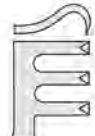


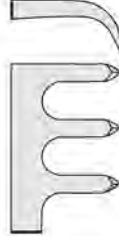

33,0 cm, 13"	
180 x 60 mm	
118.387.02	







33,0 cm, 13"	
180 x 60 mm	
118.387.03	

Wundspreizer
Self-Retaining Retractors
Separadores con retenida automática
Divaricatori autostatici

Wundspreizer
 Self-Retaining Retractors
 Separadores con retenida automática
 Divaricatori autostatici

					
	5,0 cm, 2" 118.610.05	5,0 cm, 2" 118.611.05			
					
	7,0 cm, 2 ³ / ₄ " 118.610.07	7,0 cm, 2 ³ / ₄ " 118.611.07			118.630.10
	scharf sharp agudos acuti	stumpf blunt romo smusso			scharf sharp agudos acuti
FINSEN			JANSEN		stumpf blunt romo smusso
			10,0 cm, 4"		

		scharf sharp agudos acuti	stumpf blunt romo smusso		
					
	7,0 cm, 2 ³ / ₄ " 10,0 cm, 4"	118.620.07 118.620.10	118.621.07 118.621.10		
				ALM	ALLPORT
					10,0 cm 118.624.10



SCALP-CONTOUR
14,0 cm, 5½"



118.623.01
scharf
sharp
agudos
acuti



118.633.14
stumpf
blunt
romo
smusso



ADSON-BABY
16,0 cm, 6¼"



118.684.16
scharf
sharp
agudos
acuti



118.685.16
stumpf
blunt
romo
smusso



ANDERSON-ADSON
19,0 cm, 8"



118.678.20
stumpf
blunt
romo
smusso



118.679.20
scharf
sharp
agudos
acuti



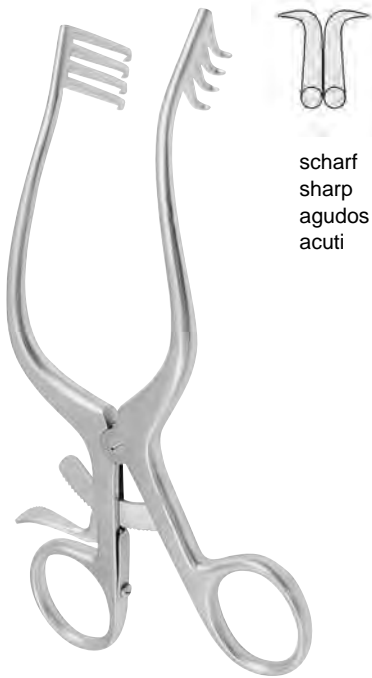
ADSON
26,5 cm, 10½"



118.682.26
scharf
sharp
agudos
acuti

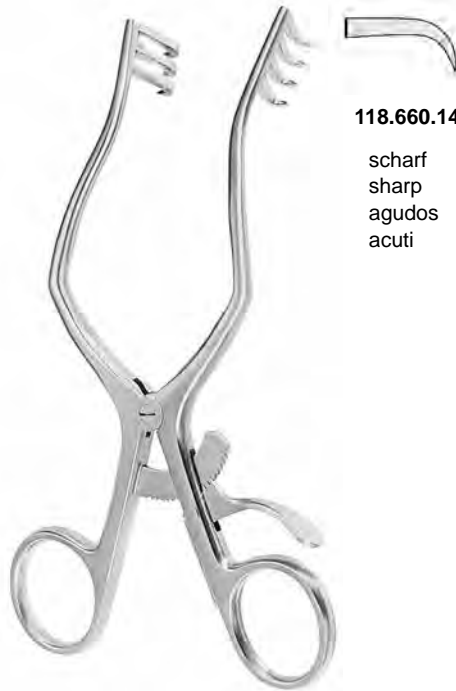


118.683.26
stumpf
blunt
romo
smusso



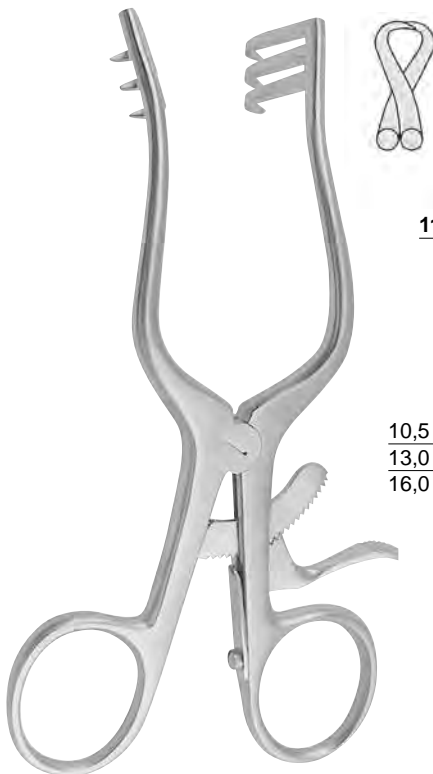
scharf
 sharp
 agudos
 acuti

MOLLISON
 15,5 cm, 6"
 118.693.15



118.660.14
 scharf
 sharp
 agudos
 acuti

SCHUHKNECHT
 12,5 cm, 5"

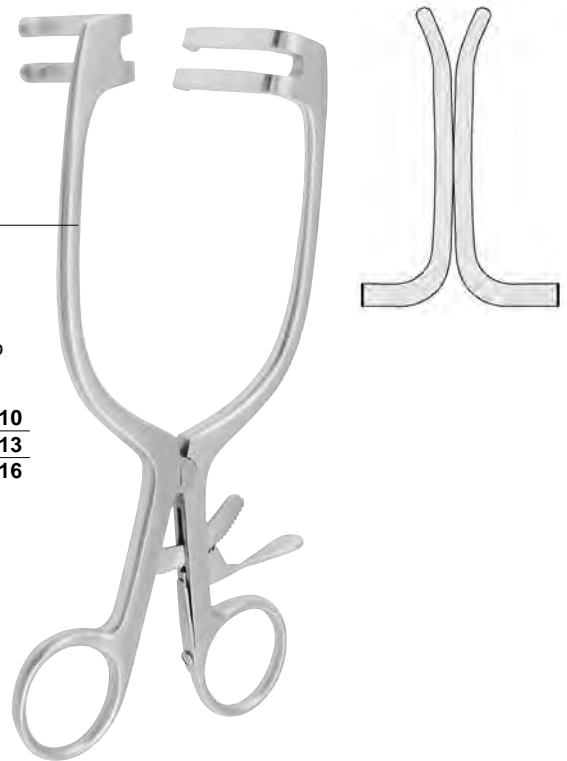


118.654.

scharf	stumpf
sharp	blunt
agudos	romo
acuti	smusso

10,5 cm, 4 ¹ / ₈ "	118.654.10	118.655.10
13,0 cm, 5"	118.654.13	118.655.13
16,0 cm, 6"	118.654.16	118.655.16

WULLSTEIN



MAYO-ADAMS
 16,5 cm, 6¹/₂"
 118.672.17



WEITLANER-LOKTITE
11,5 cm, 4 1/8"



WEITLANER
14,0 cm, 5"



WEITLANER
16,5 cm, 6 1/2"



WEITLANER
20,0 cm, 8"



Wundspreizer
 Self-Retaining Retractors
 Separadores con retenida automática
 Divaricatori autostatici



WEITLANER
 24,0 cm, 9½"



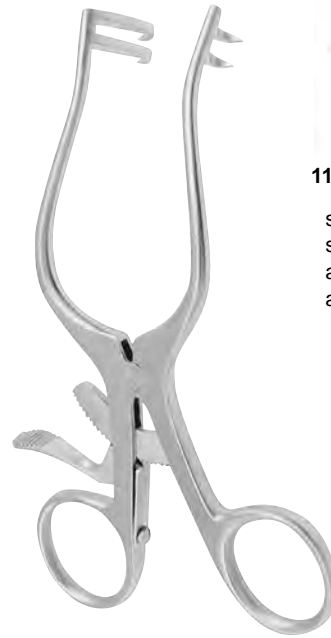
118.670.24

scharf
 sharp
 agudos
 acuti



118.671.24

stumpf
 blunt
 romo
 smusso



PLESTER
 13,0 cm, 5"



118.656.02

scharf
 sharp
 agudos
 acuti

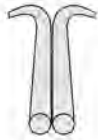


118.656.01

stumpf
 blunt
 romo
 smusso



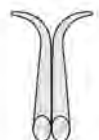
MILLIGAN
 13,0 cm, 5"
118.665.13



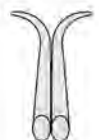
stumpf



PLESTER
 11,0 cm, 4⅓"
118.656.11



PLESTER
 11,0 cm, 4⅓"
118.656.12

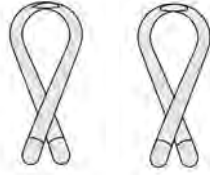




WEITLANER-BABY
13,0 cm, 5"
118.667.13



**ADSON
(CONE)**

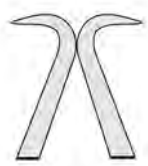


20,0 cm, 8"	118.689.20	118.685.20
26,0 cm, 10 ¹ / ₄ "	118.684.26	118.685.26

scharf	stumpf
sharp	blunt
agudos	romo
acuti	smusso



GELPI
13,5 cm, 5³/₈"
118.802.14



GELPI
19,0 cm, 7¹/₂"
118.802.18



GELPI-LOKTITE
18,0 cm, 7¹/₂"
118.804.18



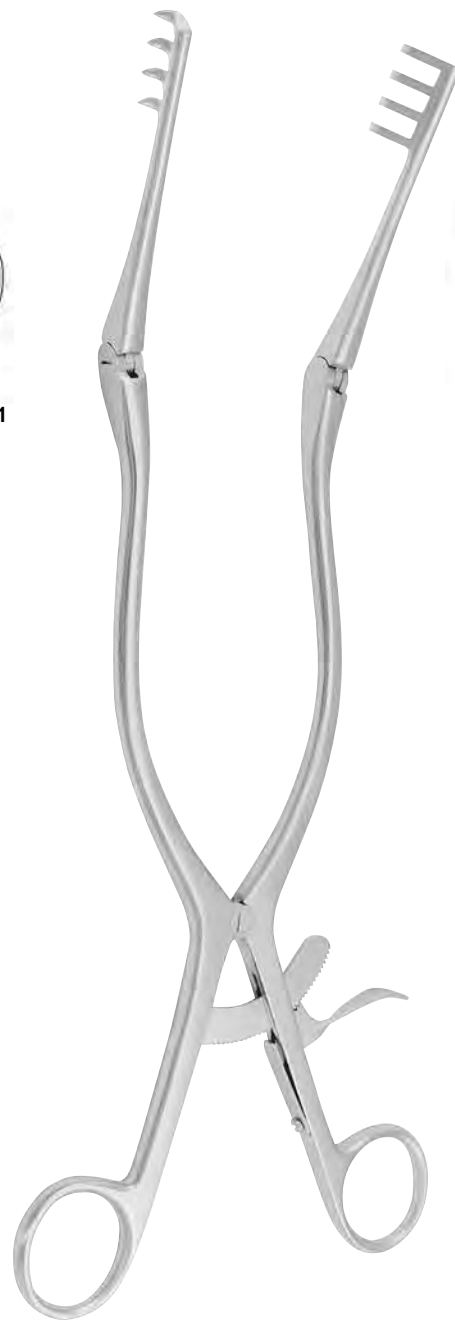
BECKMANN-ADSON
 31,0 cm, 12¹/₄"



118.686.02
 scharf
 sharp
 agudos
 acuti



118.686.01
 stumpf
 blunt
 romo
 smusso



BECKMANN
 31,0 cm, 12¹/₄"
118.690.31

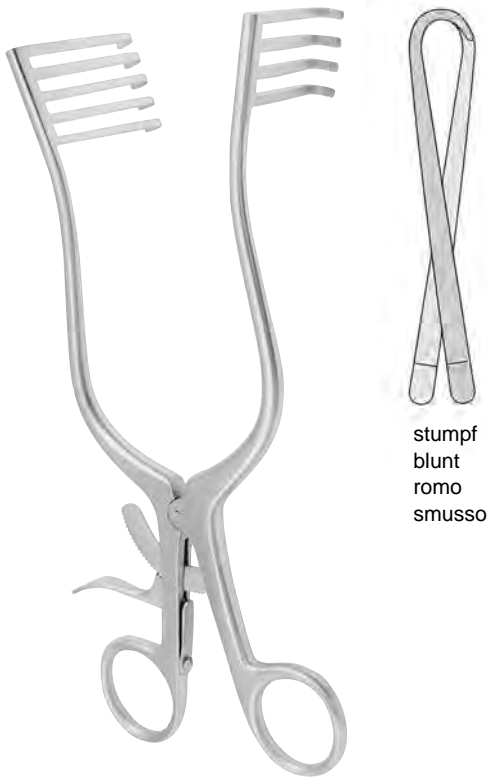


scharf
 sharp
 agudos
 acuti



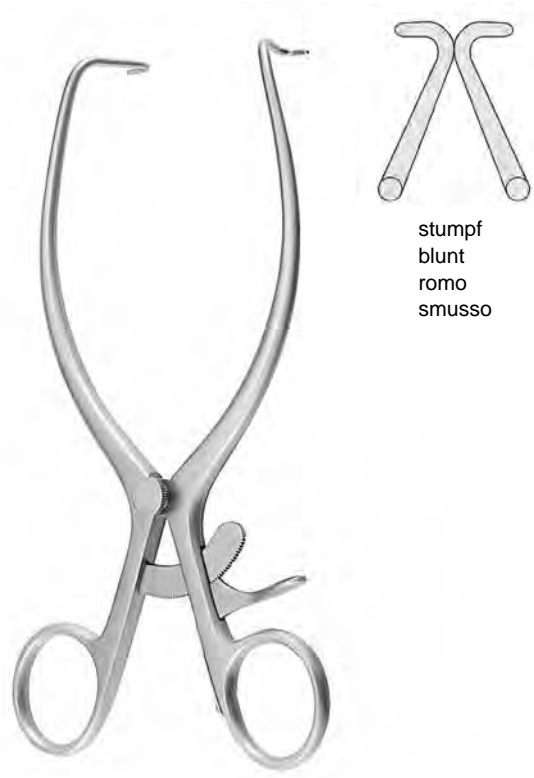
BECKMANN
32,0 cm, 12¹/₂"
118.686.32

Wundspreizer
 Self-Retaining Retractors
 Separadores con retenida automática
 Divaricatori autostatici



stumpf
 blunt
 romo
 smusso

NORFOLK AND NORWICH
 22,0 cm, 8⁵/₈"
 118.699.22



stumpf
 blunt
 romo
 smusso

GELPI-SELETZ
 16,5 cm, 7"
 118.807.16

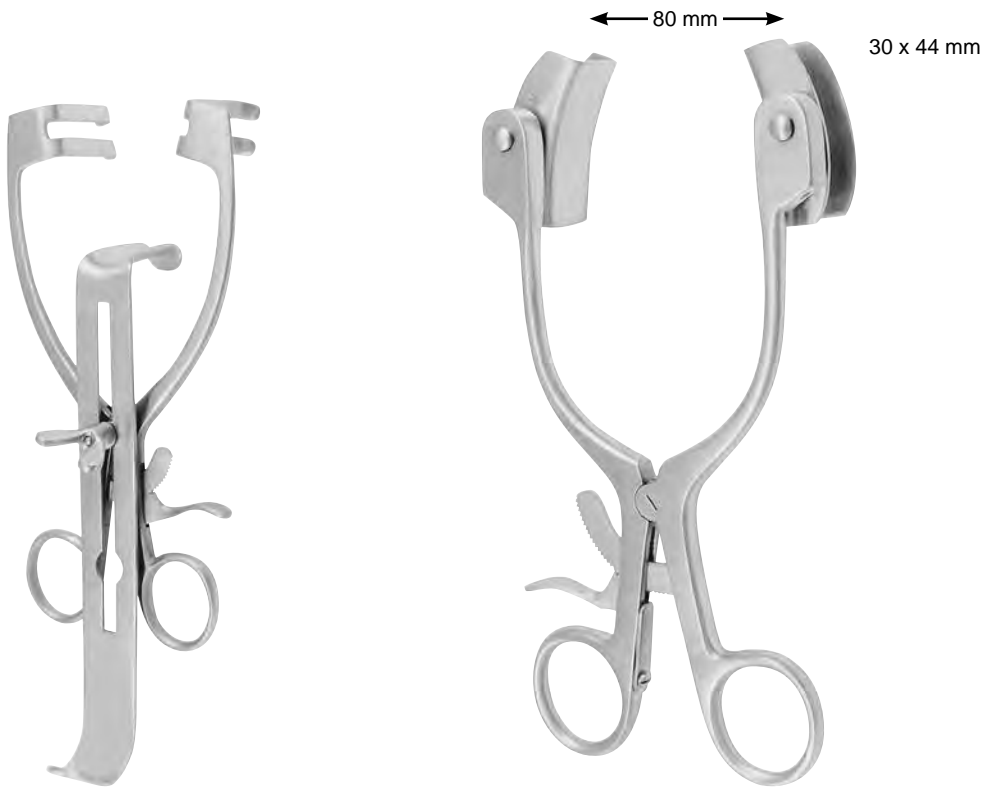


RICHTER
 16,0 cm, 6³/₄"
 118.808.16



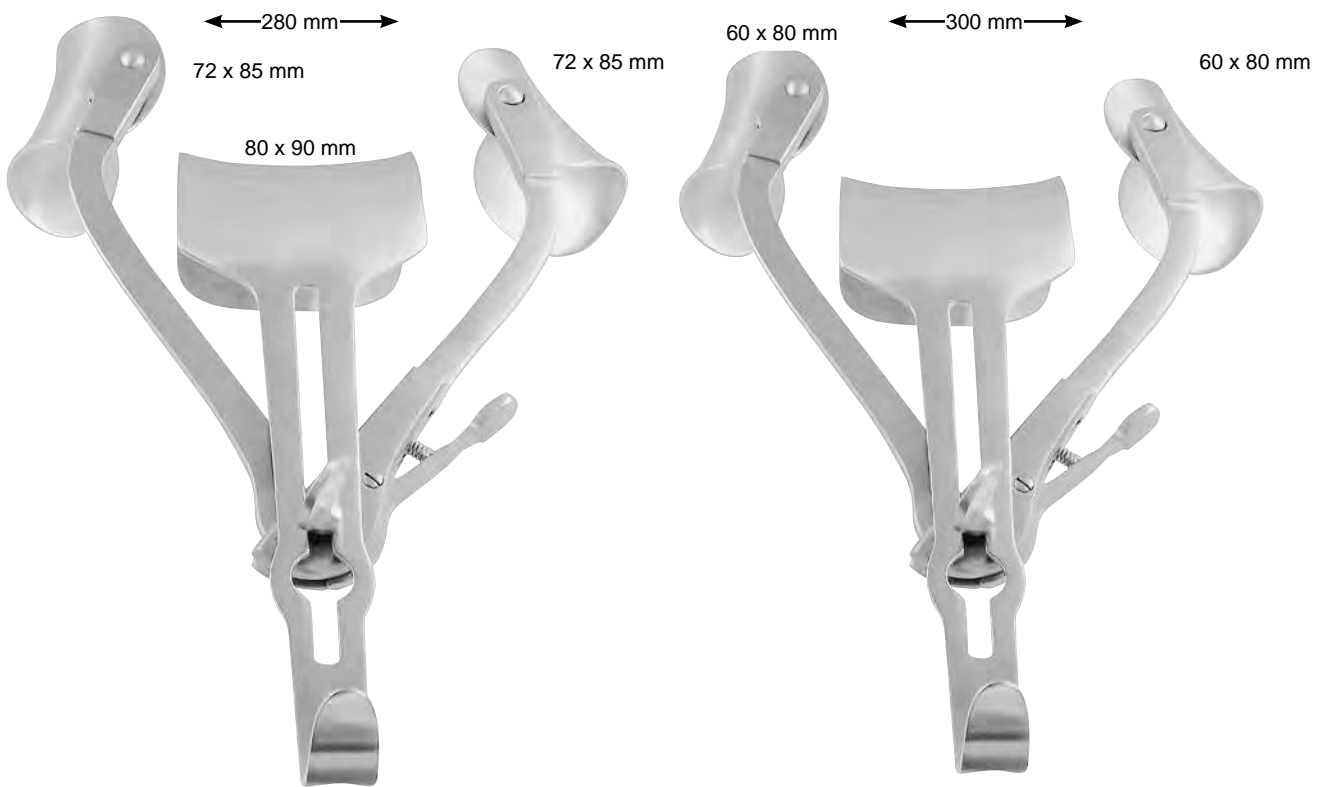
JOLL (FRIEDMAN)
 15,5 cm, 6"
 154.512.15

Wundspreizer, Bauchdeckenhalter
 Self-Retaining Retractors, Abdominal Retractors
 Separadores con retenida automática, Separadores abdominales
 Divaricatori autostatici, Divaricatori addominali



MAYO-ADAMS
 17,0 cm, 6³/₄"
 118.817.02

COLLIN-BABY
 18,0 cm, 7"
 118.814.18



RICARD
 28,0 cm, 11"
 118.822.28

RICARD
 30,0 cm, 12"
 118.822.30



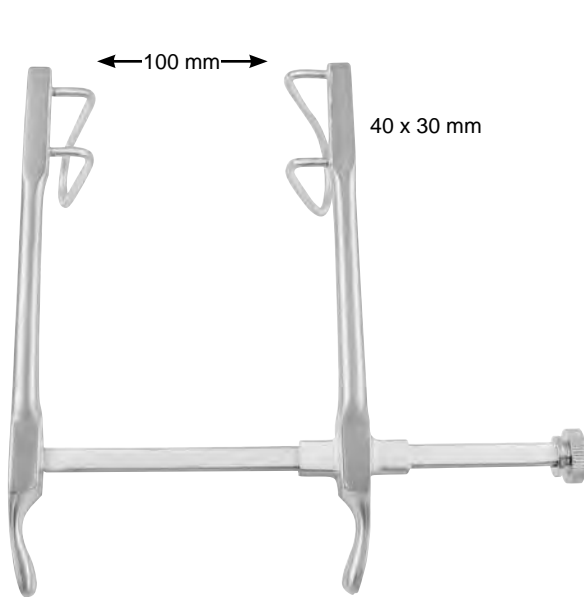
COLLIN
23,5 cm, 9 1/4"
118.812.60



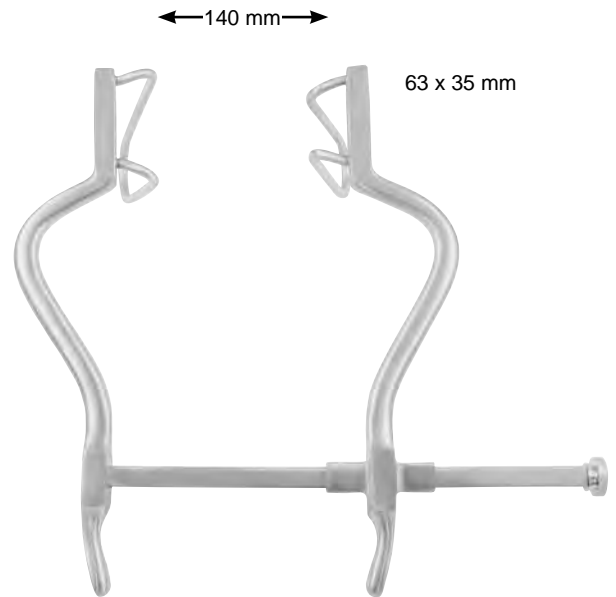
COLLIN
23,5 cm, 9 1/4"
118.812.80

Wundspreizer, Bauchdeckenhalter
Self-Retaining Retractors, Abdominal Retractors
Separadores con retenida automática, Separadores abdominales
Divaricatori autostatici, Divaricatori addominali

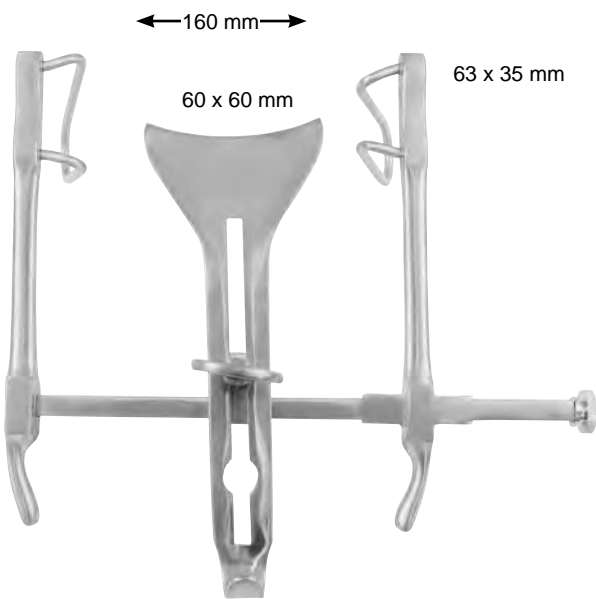




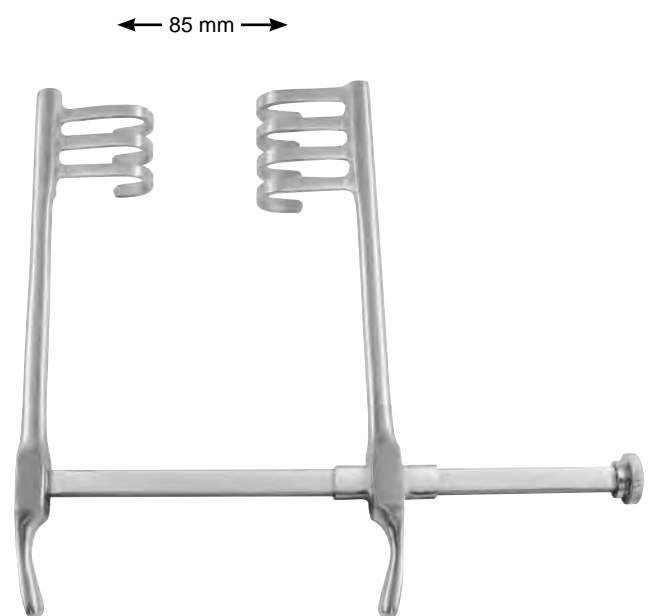
GOSSET
118.760.10



GOSSET
118.760.14



GOSSET
118.762.16

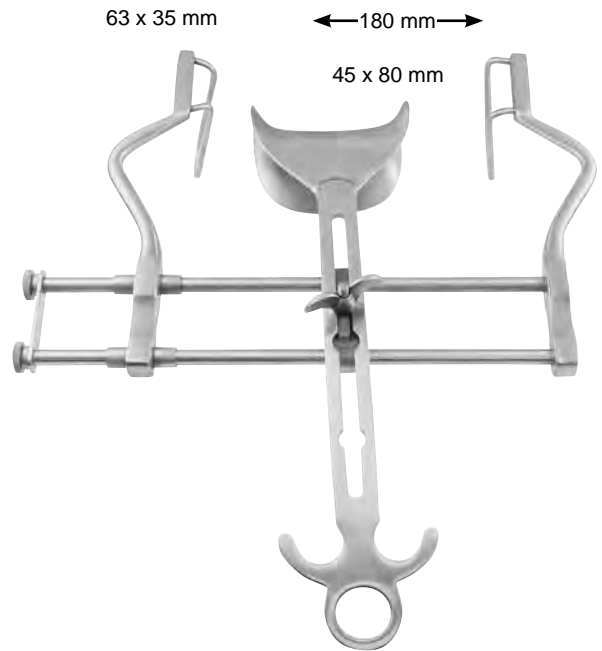


FRAZIER
118.758.85

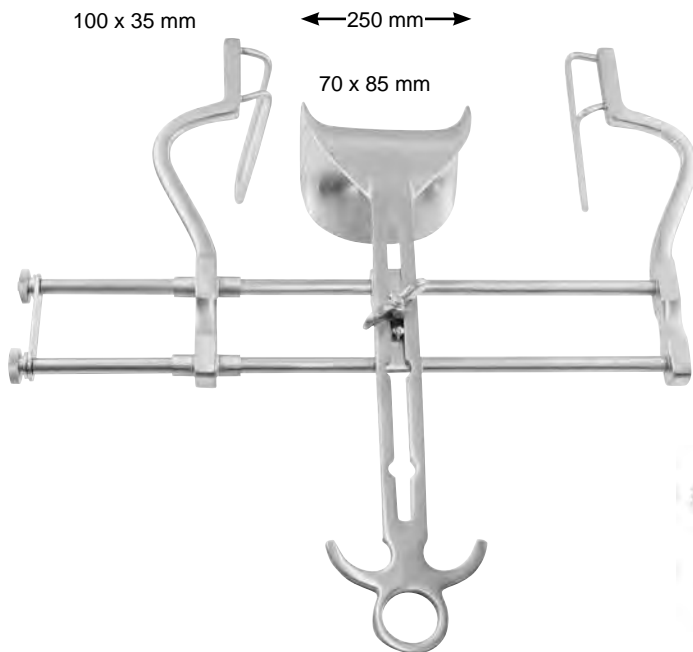
Bauchdeckenhalter
 Abdominal Retractors
 Separadores abdominales
 Divaricatori addominali



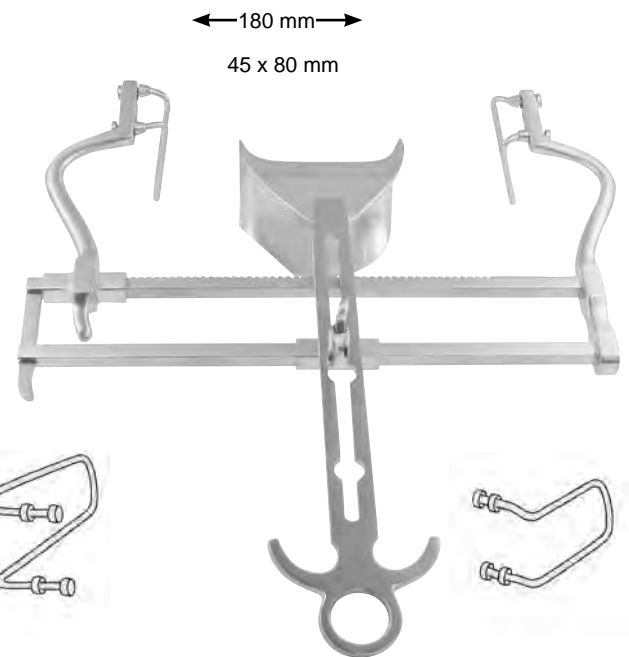
BALFOUR
 118.764.20



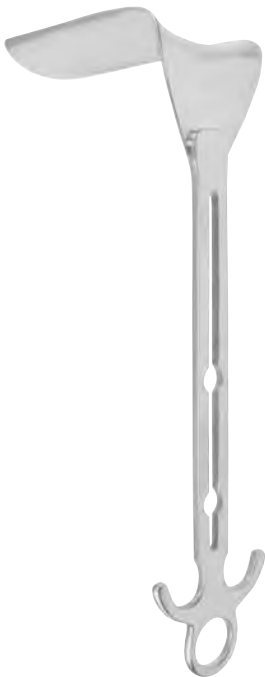
BALFOUR
 118.764.18



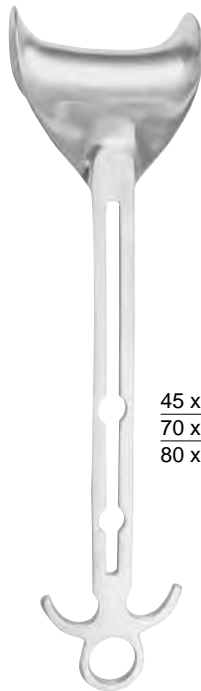
BALFOUR
 118.764.25



BALFOUR US-TYPE
 118.764.98

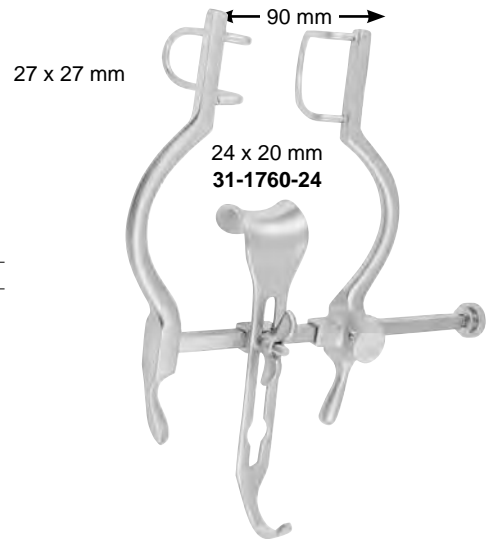


BALFOUR
100 x 70 mm
118.765.90



BALFOUR

45 x 80 mm	118.765.45
70 x 85 mm	118.765.70
80 x 90 mm	118.765.80



BALFOUR
118.766.90

geschwärzt, black finish, negra, nera;



13 mm



51 x 38 mm



70 x 60 mm



89 x 60 mm



114 x 60 mm

geschwärzt, black finish, negra, nera



19 x 76 mm



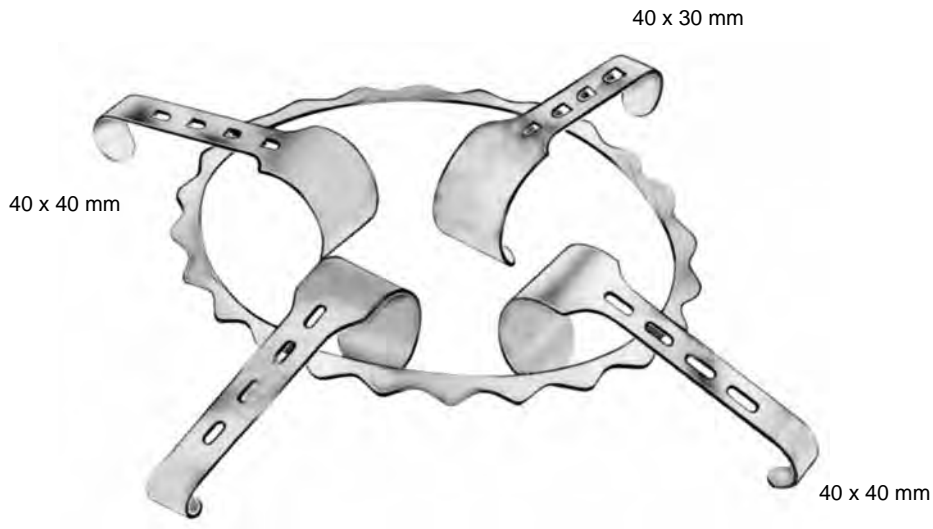
38 x 102 mm



57 x 89 mm



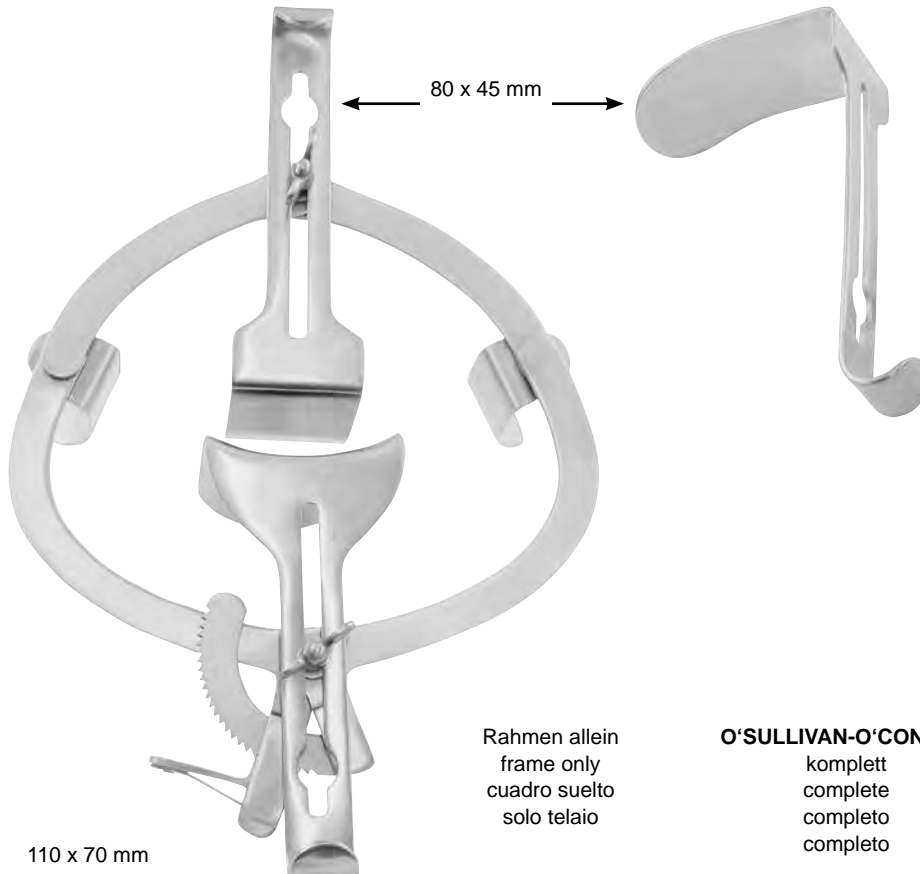
57 x 114 mm



40 x 30 mm

255 x 180 mm
Rahmen allein
frame only
cuadro suelto
solo telaio

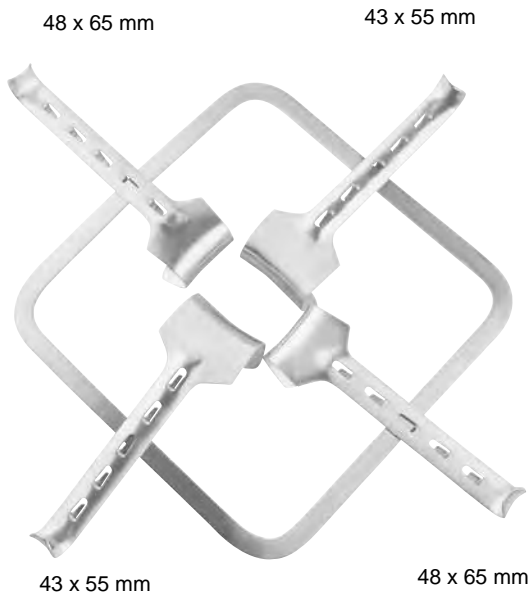
DENNIS BROWN
255 x 180 mm
komplett
complete
completo
completo



110 x 70 mm

Rahmen allein
frame only
cuadro suelto
solo telaio

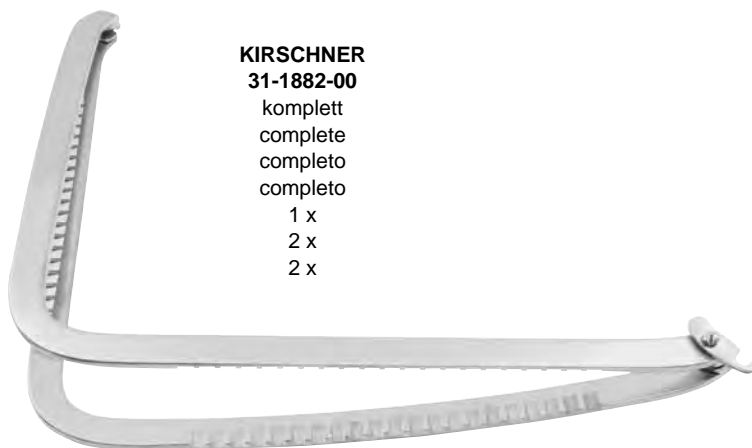
O'SULLIVAN-O'CONNOR
komplett
complete
completo
completo



250 x 250 mm
 300 x 320 mm
 300 x 380 mm
 Rahmen allein
 frame only
 cuadro suelto
 solo telaio

KIRSCHNER
 komplett
 complete
 completo
 completo
 1 x
 2 x
 2 x

255 x 255 mm
 zusammenlegbarer Rahmen, allein
 folding frame, only
 cuadro plegable, suelto
 telaio pieghevole, solo



KIRSCHNER
31-1882-00
 komplett
 complete
 completo
 completo
 1 x
 2 x
 2 x



43 x 55 mm
 48 x 65 mm
 80 x 90 mm
 90 x 65 mm
 98 x 95 mm

KIRSCHNER



KIRSCHNER
60 x 82 mm



KIRSCHNER-BALFOUR
83 x 82 mm



KIRSCHNER
98 x 51 mm
105 x 38 mm

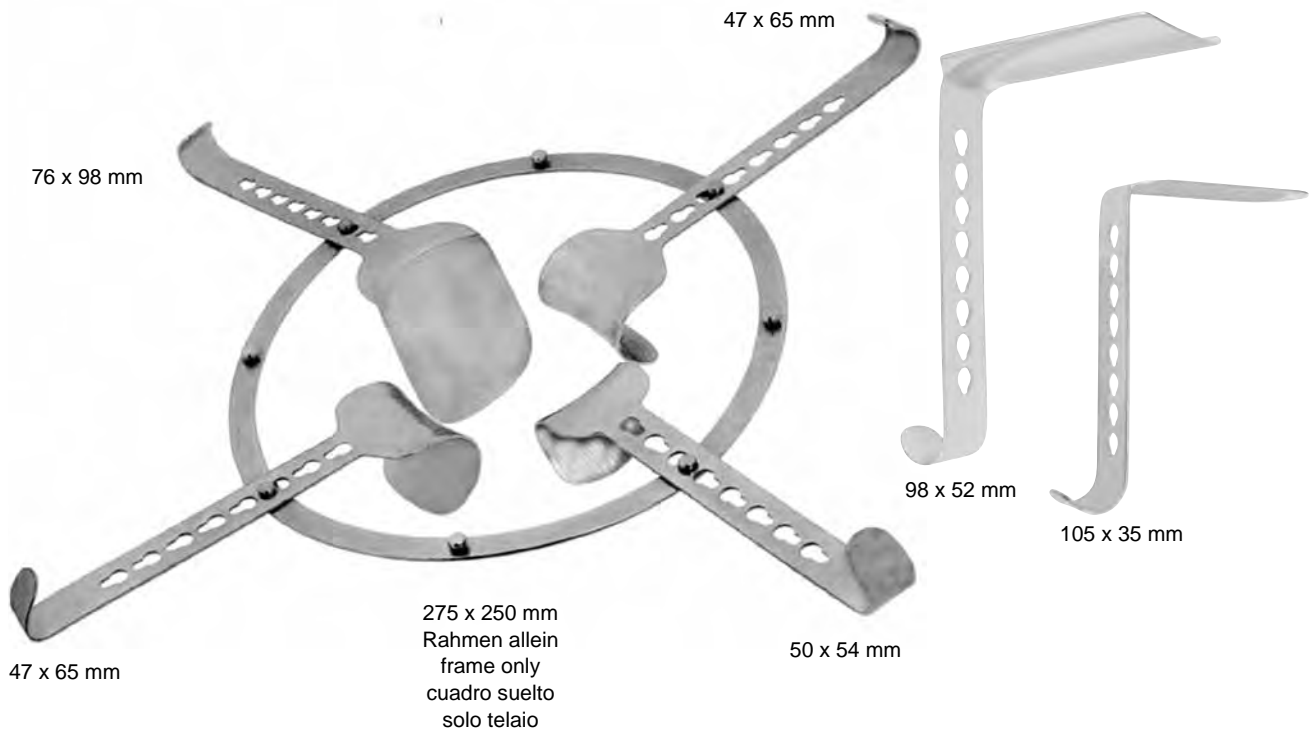


48 x 65 mm

300 x 240 mm
Rahmen allein
frame only
cuadro suelto
solo telaio

80 x 90 mm

KIRSCHNER, oval
komplett, complete, completo, comple to
1 x
3 x
1 x
1 x
1 x



FRANZ
 komplett
 complete
 completo
 completo
 1 x
 2 x
 2 x

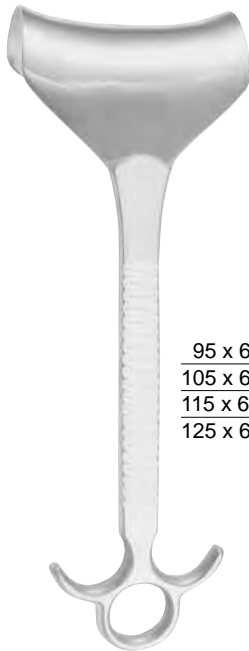


38 x 60 mm
 45 x 80 mm



50 x 65 mm
 60 x 85 mm

für / for / para / per



95 x 60 mm
105 x 65 mm
115 x 65 mm
125 x 65 mm

DOYEN
28,0 cm, 11"



Kette mit Gewicht
Chain with weight
Cadena con pesa
Catena con peso

78,5 cm, 31"



53,0 cm, 21"
66,0 cm, 26"

Befestigungsgestell
Mounting frame
Bastidor para la fijación
Telaio di supporto per il fissaggio

ROCHARD



53,0 cm, 21"
66,0 cm, 26"

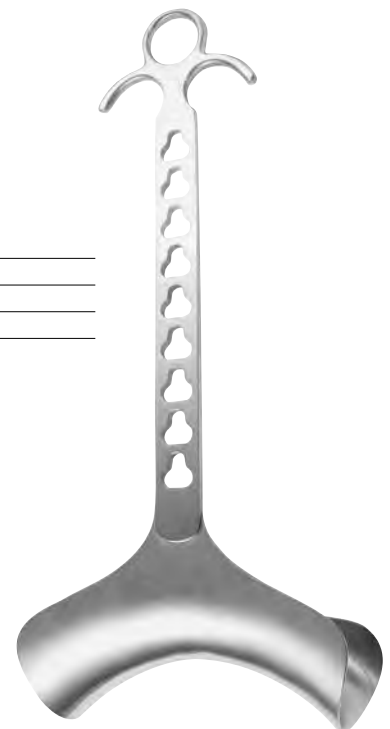
ROCHARD

Befestigungsgestell
Mounting frame
Bastidor para la fijación
Telaio di supporto per il fissaggio



95 x 48 mm
105 x 48 mm
115 x 48 mm
125 x 48 mm
155 x 48 mm

ROCHARD
28,0 cm, 11"



ROCHARD
28,0 cm, 11"

**Bauchspatel
Abdominal Spatulas
Espátulas abdominales
Spatole addominali**



biegsam
malleable
maleable
malleabile

200 x 6 mm **118.168.06**
200 x 12 mm **118.168.12**
200 x 17 mm **118.168.17**
200 x 20 mm **118.168.20**
200 x 25 mm **118.168.25**

RIBBON



biegsam
malleable
maleable
malleabile

330 x 19 mm **118.170.19**
330 x 25 mm **118.170.25**
330 x 32 mm **118.170.32**
330 x 40 mm **118.170.40**
330 x 50 mm **118.170.50**

RIBBON



biegsam
malleable
maleable
malleabile

280 x 25/30 mm **118.174.25**
300 x 37/45 mm **118.175.37**

HABERER



biegsam
malleable
maleable
malleabile

HABERER
200 x 25/17 mm
118.174.17

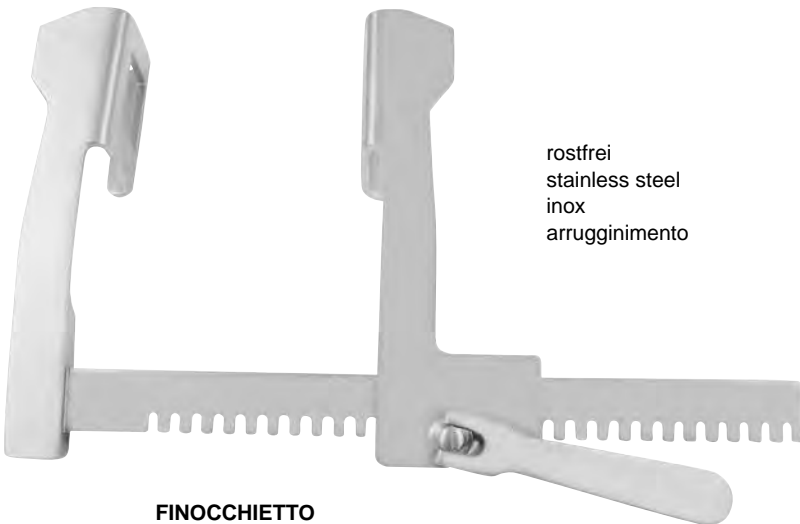


REVERDIN
280 x 45/60 mm
118.175.28



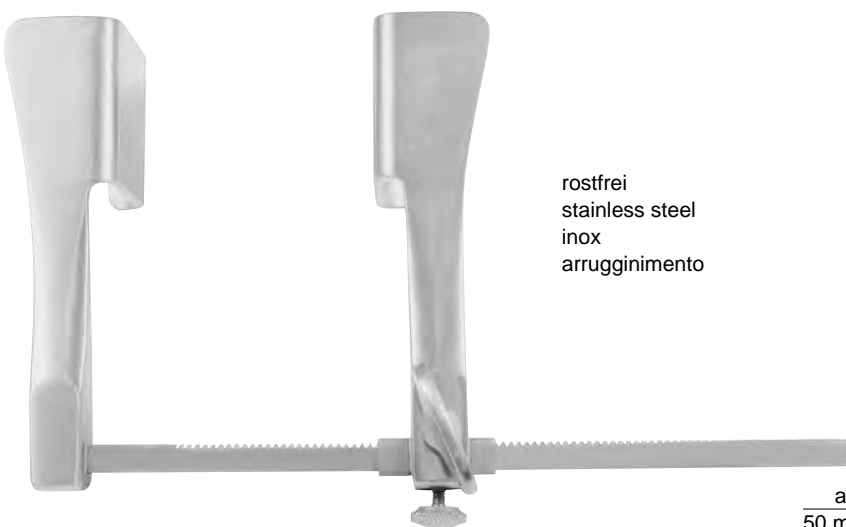
FINOCCHIETTO-BABY

a	b	c	
18 mm	20 mm	75 mm	156.214.75



FINOCCHIETTO

a	b	c	
40 mm	40 mm	165 mm	156.210.16
45 mm	65 mm	200 mm	156.210.20
70 mm	65 mm	250 mm	156.210.25



TUFFIER

a	b	c	
50 mm	45 mm	165 mm	156.264.16

Sonden, Trokare
Probes, Trocars
Sondas, Trócares
Sonde, Trequarti



	Ø 1,0 mm	Ø 2,0 mm
11,5 cm, 4 1/2"	120.104.11	120.106.11
13,0 cm, 5"	120.104.13	120.106.13
14,5 cm, 5 3/4"	120.104.14	120.106.14
16,0 cm, 6 1/4"	120.104.16	120.106.15
18,0 cm, 7"	120.104.18	120.106.18
20,0 cm, 8"	120.104.20	120.106.20

Ø 2,0 mm



11,5 cm, 4 1/2"	120.102.11
13,0 cm, 5"	120.102.13
14,5 cm, 5 3/4"	120.102.14
16,0 cm, 6 1/4"	120.102.16
18,0 cm, 7"	120.102.18
20,0 cm, 8"	120.102.20

Ø 1,0 mm



Silber
Silver
Plata
Argento

STACKE
10,5 cm, 4 1/8"
120.115.10



Myrtenblattsonden
Myrtle leaf probes
Sondas para mirto
Sonde a foglia di mirto

10,5 cm, 4 1/2"	120.108.10
13,0 cm, 5"	120.108.13
14,5 cm, 5 3/4"	120.108.14
16,0 cm, 6 1/4"	120.108.16
18,0 cm, 7"	120.108.18
20,0 cm, 8"	120.108.20



NÈLATON
16,0 cm, 6 1/4"
120.117.16



DOYEN
14,5 cm, 5 3/4"
120.111.14



BRODIE
20,0 cm, 8"
120.130.20

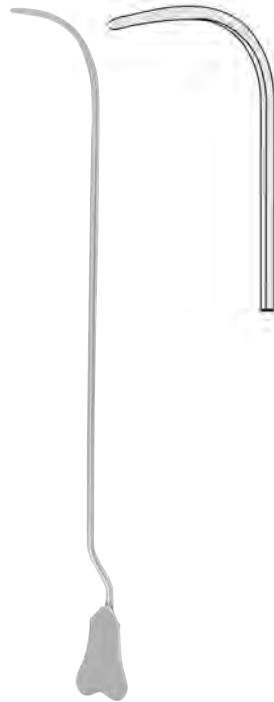
Ø 3,5 mm



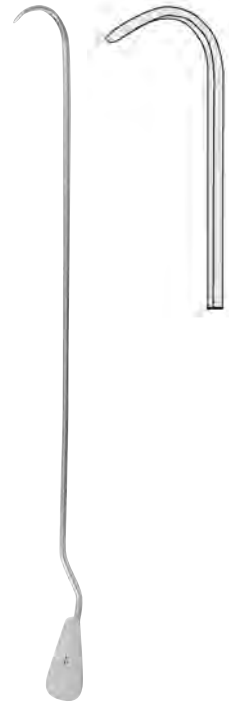
LOCKHART-MUMMERY
16,5 cm, 6 1/2"
120.122.01



LOCKHART-MUMMERY
16,5 cm, 6 1/2"
120.121.01



LOCKHART-MUMMERY
16,5 cm, 6 1/2"
120.121.02



LOCKHART-MUMMERY
16,5 cm, 6 1/2"
120.121.03



UKERMANN
 15,0 cm, 6¹/₄"
 120.310.15



JOBSON-HORNE
 18,0 cm, 7"
 120.320.18



12,0 cm, 4 ³ / ₄ "	120.270.12	Ø 0,9 mm
14,0 cm, 5 ³ / ₄ "	120.270.14	Ø 0,9 mm
16,5 cm, 6 ¹ / ₄ "	120.270.16	Ø 1,1 mm
18,0 cm, 7"	120.270.18	Ø 1,2 mm

**FARRELL
 (LATHBURY)**



12,0 cm, 4 ³ / ₄ "	120.272.12	Ø 0,9 mm
14,0 cm, 5 ³ / ₄ "	120.272.14	Ø 0,9 mm
16,5 cm, 6 ¹ / ₄ "	120.272.16	Ø 1,1 mm
18,0 cm, 7"	120.272.18	Ø 1,2 mm

FARRELL



120.150.95
Metalletui
Metal case
Estuche de metal
Scatola in metallo
135 x 100 x 25 mm



Ø 3,0 mm
120.150.03



Ø 6,0 mm
120.150.06

NABATOFF
120.150.00
komplett
complete
completo
completo



Ø 9,0 mm
120.150.09

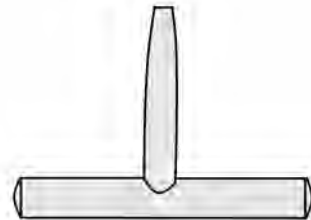


120.150.90
Zugseil
Cable
Cable
Fune



Ø 12,0 mm
120.150.12

120.150.02
Kunststoff-Sondenspitze
Plastic probe tip
Extremidad de sonda de plástico
Punta in materia plastica



120.150.80
Handgriff
Handle
Mango
Manico



Ø 3,0 mm	122.110.30
Ø 3,5 mm	122.110.35
Ø 4,0 mm	122.110.40
Ø 4,5 mm	122.110.45
Ø 5,0 mm	122.110.50
Ø 5,5 mm	122.110.55
Ø 6,0 mm	122.110.60

STANDARD
11,0 cm, 4³/₈"



Ø 3,0 mm	122.120.30
Ø 3,5 mm	122.120.35
Ø 4,0 mm	122.120.40
Ø 4,5 mm	122.120.45
Ø 5,0 mm	122.120.50
Ø 5,5 mm	122.120.55
Ø 6,0 mm	122.120.60

STANDARD
12,0 cm, 4³/₄"

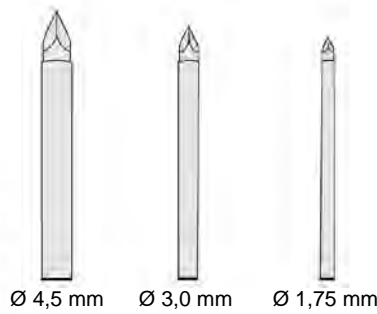


Ø 7,3 mm	122.162.07
Ø 8,7 mm	122.162.09
Ø 12,0 mm	122.162.12

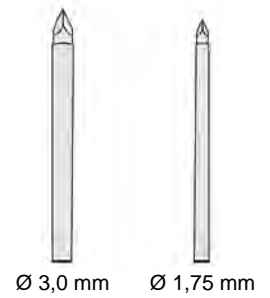
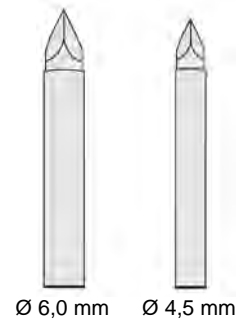
HURWITZ



UNIVERSAL
122.103.00



UNIVERSAL
122.104.00





BUELAU
Ø 8,0 mm
122.160.24

Trokare
Trocars
Trócares
Trequarti



Ø 6,0 mm	122.165.06
Ø 8,0 mm	122.165.08

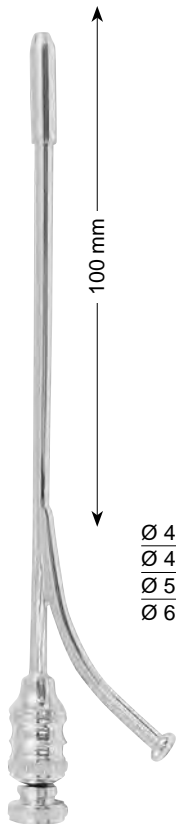
CAMPBELL
16,0 cm, 6¼"



80 mm

Ø 8,5 mm	122.170.25
Ø 10,0 mm	122.170.30
Ø 11,0 mm	122.170.33
Ø 12,0 mm	122.170.35

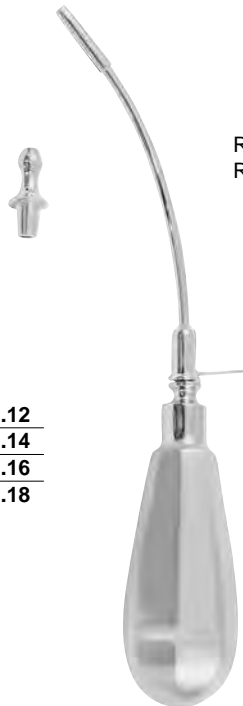
NELSON
21,0 cm, 8½"



100 mm

Ø 4,0 mm	122.150.12
Ø 4,6 mm	122.150.14
Ø 5,5 mm	122.150.16
Ø 6,0 mm	122.150.18

OCHSNER
14,0 cm, 5½"



Record Konus
Record cone

Ø 3,0 mm	122.123.30
Ø 4,0 mm	122.123.40
Ø 5,0 mm	122.123.50

PIERCE
16,0 cm, 6¼"



Ø 2,25 mm

COAKLEY
14,0 cm, 5¼"
122.140.02



Ø 1,8 mm

LICHTWITZ
20,0 cm, 8"
122.128.20



DOUGLAS
Ø 3,0 mm
122.125.11



Ø 10,0 mm **104.130.10**

POOLE
22,0 cm, 8⁵/₈"



Ø 6,0 mm **104.140.06**
Ø 8,0 mm **104.140.08**

POOLE
22,0 cm, 8⁵/₈"

Saugrohre
Suction Tubes
Tubos para aspiración
Tubi aspirazione

auswechselbare Spitze
 interchangeable tip
 punta intercambiabile
 tipo intercambiabile



COUPLAND
 17,0 cm, 6³/₄"
 104.165.00

Ø 2,0 mm

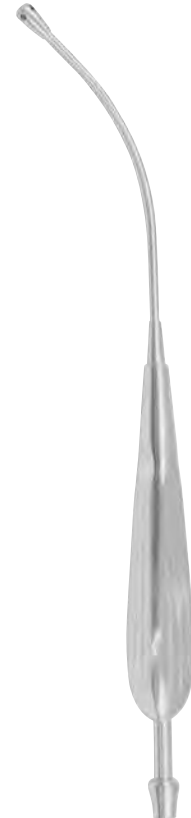


YANKAUER
 27,0 cm, 10⁵/₈"
 104.150.27

Olive allein
 Olive only
 Oliva suelto
 Olivo solo



DE BAKEY
 27,0 cm, 10⁵/₈"
 104.154.27



ANDREWS-PYNCHON
 24,0 cm, 9¹/₂"
 104.152.01

Ø 2,0 mm



COOLEY
 35,0 cm, 13³/₄"
 Ø 8,0 mm
 104.141.35



COOLEY
 31,0 cm, 11³/₄"
 Ø 10,0 mm
 104.143.31



COOLEY
 33,0 cm, 13"
 Ø 8,0 mm
 104.147.33

Ø 4,0 mm



ADSON
21,0 cm, 8 1/4"
140.290.21



MAGILL
17,5 cm, 6 5/8"

Ø 3,0 mm	104.155.30
Ø 3,5 mm	104.155.35
Ø 4,0 mm	104.155.40



FRAZIER
19,0 cm, 7 1/2"

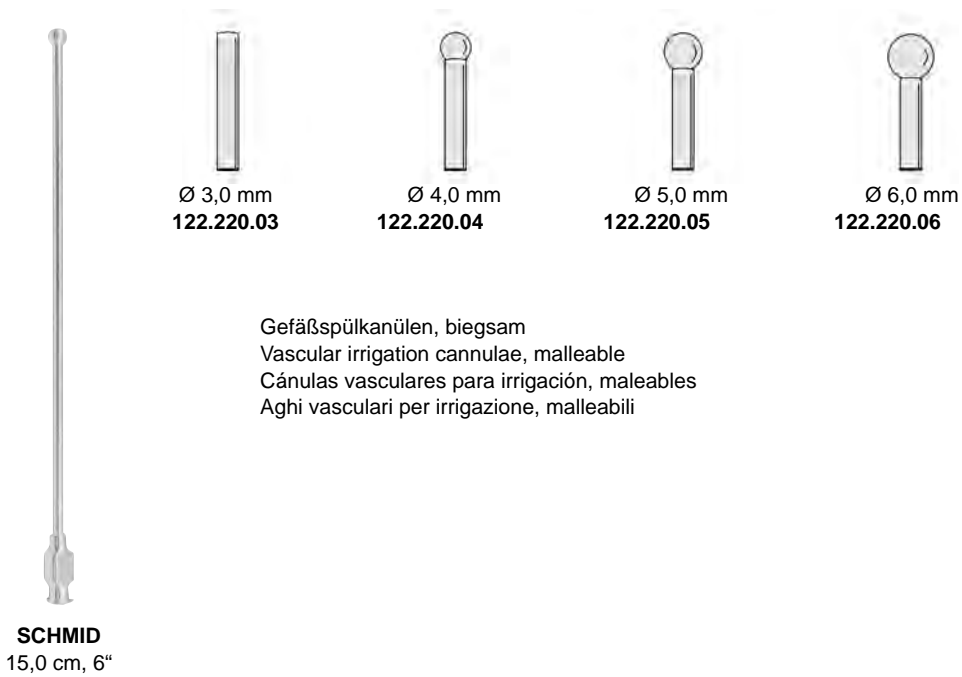
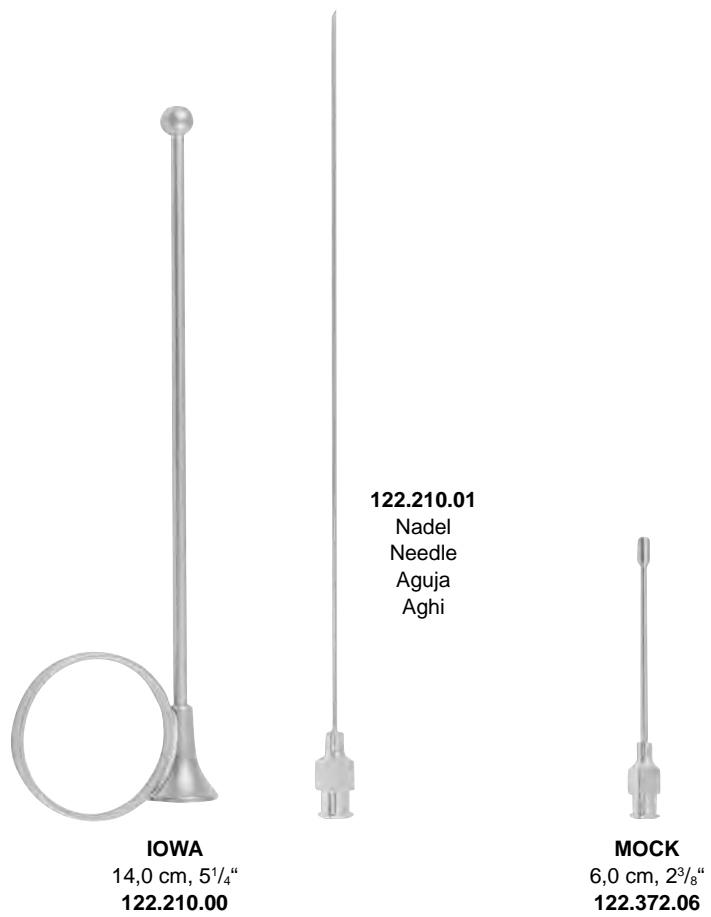
Charr. 6	140.295.06
Charr. 8	140.295.08
Charr. 10	140.295.10
Charr. 12	140.295.12



FERGUSON
18,0 cm, 7"

Charr. 6	140.270.06
Charr. 8	140.270.08
Charr. 10	140.270.10
Charr. 12	140.270.12

Ø 1,0 x 185 mm





Ø 1,20 x 60 mm **122.416.12**
Ø 1,50 x 80 mm **122.418.15**



VERESS

Ø 2,00 x 100 mm **122.250.10**
Ø 2,00 x 120 mm **122.250.12**
Ø 2,00 x 150 mm **122.250.15**



KLIMA-ROSSEGGER
Ø 1,8 x 35 mm
122.360.15



Kanülen zur Sternalpunktion
Sternum puncture needles
Agujas para la punción del esternón
Aghi per puntura dello sterno



BIER

Kanülen zur Lumbalpunktion
Lumbar puncture needles
Agujas para punción lumbar
Aghi per punture lombari

Ø 1,0 80 mm **122.236.10**
Ø 1,2 80 mm **122.236.12**

Kanülen zur Lumbalpunktion
 Lumbar puncture needles
 Agujas para punción lumbar
 Aghi per punture lombari



Ø 1,20 x 76 mm	122.230.12
Ø 1,20 x 89 mm	122.232.12
Ø 1,00 x 76 mm	122.230.10
Ø 1,00 x 89 mm	122.232.10
Ø 0,70 x 76 mm	122.230.07
Ø 0,70 x 50 mm	122.234.07
Ø 0,70 x 89 mm	122.232.07

QUINKE

Kanülen zur Leberblindpunktion
 Liver blind puncture needles
 Agujas para punción ciega del hígado
 Aghi per punture cieca del fegato



Ø 1,00 x 35 mm	122.302.01
Ø 1,00 x 70 mm	122.302.02
Ø 1,20 x 70 mm	122.302.03
Ø 1,20 x 100 mm	122.302.04
Ø 1,40 x 70 mm	122.302.05
Ø 1,40 x 100 mm	122.302.06
Ø 1,60 x 70 mm	122.302.07
Ø 1,80 x 100 mm	122.302.08

MENGHINI

Kanülen zur gezielten Leberpunktion
 Needles for controlled liver puncture
 Agujas para la punción del hígado bajo el control laparoscópico
 Aghi per la punture controllata del fegato



Ø 1,40 x 168 mm	122.310.14
Ø 1,80 x 168 mm	122.310.18

MENGHINI

Trokare für Kanülen
 Trocars for needles
 Trocares para agujas
 Trequarti oer aghi



Ø 1,40 x 168 mm	122.312.14
Ø 1,80 x 168 mm	122.312.18



LUER

1 ml	120.500.01
2 ml	120.500.02
5 ml	120.500.05
10 ml	120.500.10
20 ml	120.500.20
50 ml	120.500.50



LUER-LOCK

1 ml	120.510.01
2 ml	120.510.02
5 ml	120.510.05
10 ml	120.510.10
20 ml	120.510.20
50 ml	120.510.50



LUER-LOCK

2 ml	150.290.02
5 ml	150.290.05
10 ml	150.290.10

Spritzen
Syringes
Jeringas
Siringhe



Nahtinstrumente
Suture Instruments
Instrumentos para sutura
Strumenti per sutura



DERF



124.110.12
12,0 cm, 4³/₄"



124.120.12
12,5 cm, 5"



COLLIER
12,5 cm, 5"
124.122.12



WEBSTER
13,0 cm, 5"
124.100.13



HALSEY
13,0 cm, 5"



124.130.13



124.140.13



NEIVERT
13,0 cm, 5"
124.146.13



HEGAR-BAUMGARTNER
14,0 cm, 5¹/₂"
124.180.14





124.148.13
13,0 cm, 5"

BROWN



CRILE-MURRAY
15,0 cm, 6"
124.170.15



124.160.15
15,0 cm, 6"

CRILE-WOOD



ADSON
18,0 cm, 7"
124.292.18



METZENBAUM
18,0 cm, 7"
124.290.18



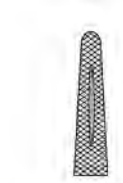
MAYO-HEGAR



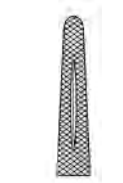
124.180.14
14,0 cm, 5½"



124.180.16
16,0 cm, 6¼"



124.180.18
18,0 cm, 7"



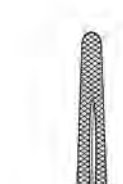
124.180.20
20,0 cm, 8"



124.180.24
24,0 cm, 9½"



124.180.26
26,0 cm, 10¼"



124.180.30
30,0 cm, 12"



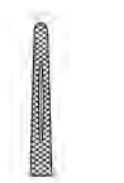
MAYO-HEGAR-DELICATE



124.190.16
16,0 cm, 6¼"



124.190.18
18,0 cm, 7"



124.190.20
20,0 cm, 8"



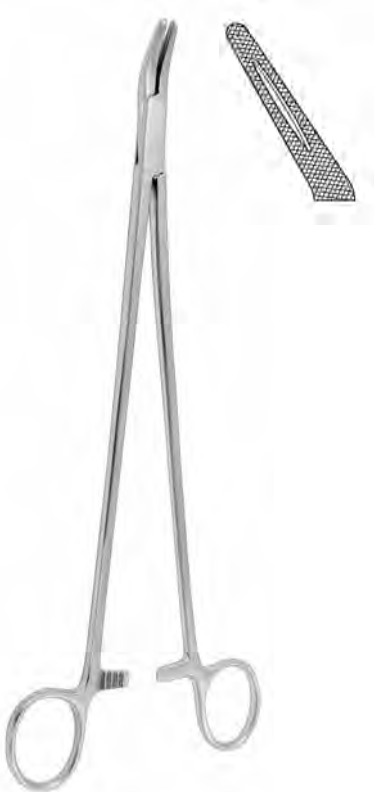
HEANEY
21,0 cm, 8¹/₄"
124.241.21



JAMISON
23,5 cm, 9¹/₄"
124.230.23



MASSON
27,0 cm, 10¹/₂"
124.250.27



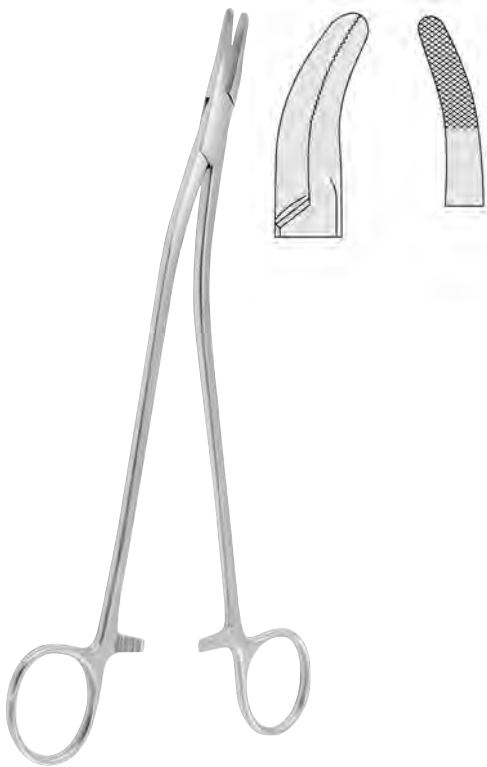
FINOCCHIETTO
27,0 cm, 10¹/₂"
124.311.27



WANGENSTEEN
27,0 cm, 10¹/₂"
124.260.27



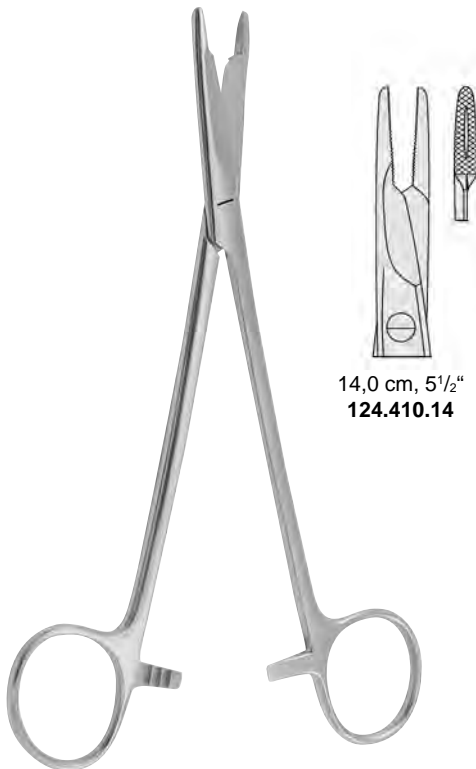
JOHNSON
27,0 cm, 10¹/₂"
124.293.27



STRATTE
23,0 cm, 9"
124.330.23

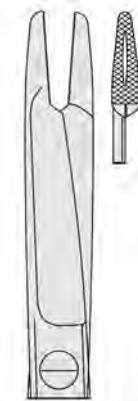


OLSEN-HEGAR
17,0 cm, 6³/₄"
124.420.17



OLSEN-HEGAR

14,0 cm, 5¹/₂"
124.410.14



18,0 cm, 7"
124.410.18



TOENNIS
18,0 cm, 7"
124.360.18



124.370.14
14,0 cm, 5½"



124.370.17
17,0 cm, 6¾"



124.370.20
20,0 cm, 8"



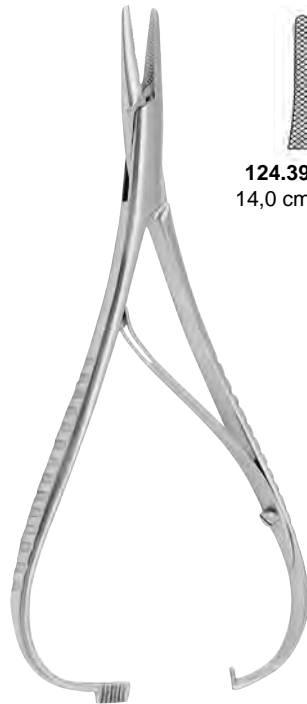
124.380.17
17,0 cm, 6¾"



124.380.20
20,0 cm, 8"

MATHIEU

MATHIEU



124.390.14
14,0 cm, 5½"



124.390.17
17,0 cm, 6¾"

MATHIEU

Nadelhalter, Mikro-Nadelhalter
Needle Holders, Micro Needle Holders
Porta-agujas, Micro Porta-agujas
Portaghi, Micro Portaghi



124.650.10

124.651.10

BARRAQUER-TROUTMAN
10,0 cm, 4"



124.661.13

BARRAQUER



BARRAQUER
13,0 cm, 5³/₈"
124.663.13



124.690.18



124.691.18



ohne Sperre
without ratchet
sin cremallera
senza cremagliera

18,5 cm, 7¹/₄"



124.666.18



mit Sperre
with ratchet
con cremallera
con cremagliera

18,5 cm, 7¹/₄"



124.670.14



124.671.14



124.674.14



124.675.14



mit Sperre
with ratchet
con cremallera
con cremagliera

CASTROVIEJO
14,5 cm, 5³/₄"



124.670.18



124.671.18



mit Sperre
with ratchet
con cremallera
con cremagliera

CASTROVIEJO
18,0 cm, 7"

Mikro-Nadelhalter
Micro Needle Holders
Micro Porta-agujas
Micro Portaghi





KALT
13,5 cm, 5³/₈"
124.628.14



DIETHRICH

16,0 cm, 5 ³ / ₈ "	124.444.16
18,0 cm, 7"	124.444.18
20,0 cm, 8"	124.444.20
23,0 cm, 9"	124.444.23
26,0 cm, 10 ¹ / ₄ "	124.444.26



WEBSTER
13,0 cm, 5"
124.104.13



DERF
12,0 cm, 4³/₄"
124.114.12



124.184.14
14,0 cm, 5¹/₂"

HEGAR-BAUMGARTNER

Nadelhalter mit Hartmetalleinlagen
Needle Holders with tungsten carbide inserts
Porta-agujas con bocas de carburo tungsteno
Portaghi con morsi in carburo di tungsteno

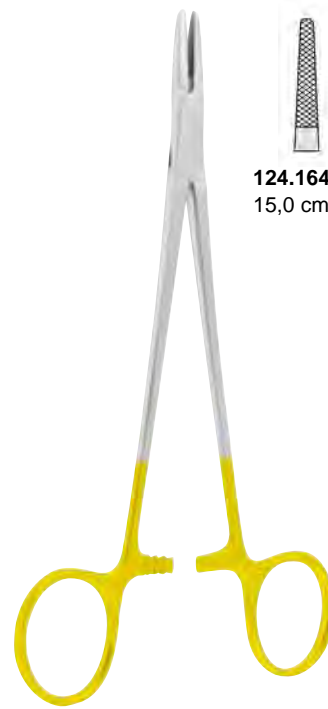


124.134.13



124.144.13

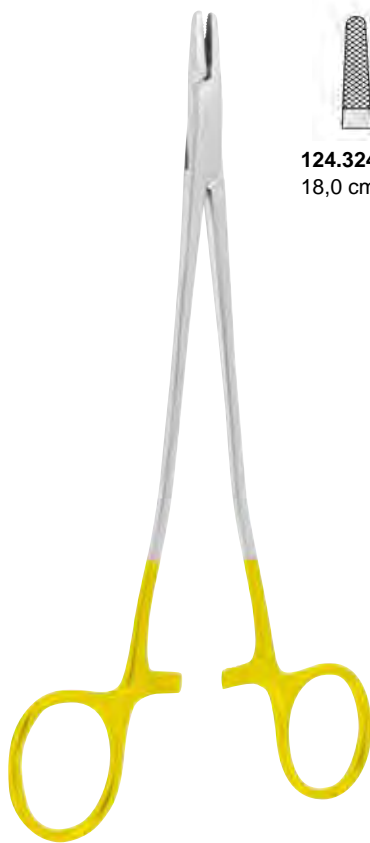
HALSEY
13,0 cm, 5"



124.164.15
15,0 cm, 6"

124.164.18
18,0 cm, 7"

CRILE-WOOD



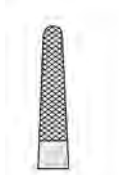
124.324.18
18,0 cm, 7"

124.324.26
26,0 cm, 10¹/₄"

SAROT



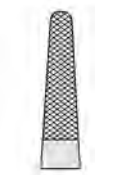
MAYO-HEGAR



124.184.16
16,0 cm, 6 1/4"



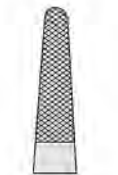
124.184.18
18,0 cm, 7"



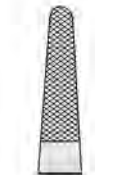
124.184.20
20,0 cm, 8"



124.184.24
24,0 cm, 9 1/2"



124.184.26
26,0 cm, 10 1/4"



124.184.30
30,0 cm, 12"



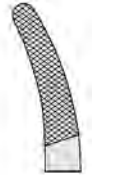
MAYO-HEGAR (HEANEY)



124.245.20
21,0 cm, 8"



124.245.24
24,0 cm, 9 1/4"



124.245.26
26,0 cm, 10 1/4"

Nadelhalter mit Hartmetalleinlagen
 Needle Holders with tungsten carbide inserts
 Porta-agujas con bocas de carburo tungsteno
 Portaghi con morsi in carburo di tungsteno



DE BAKEY



124.214.18
 18,0 cm, 7"



124.214.20
 20,0 cm, 8"



124.214.23
 23,0 cm, 9"



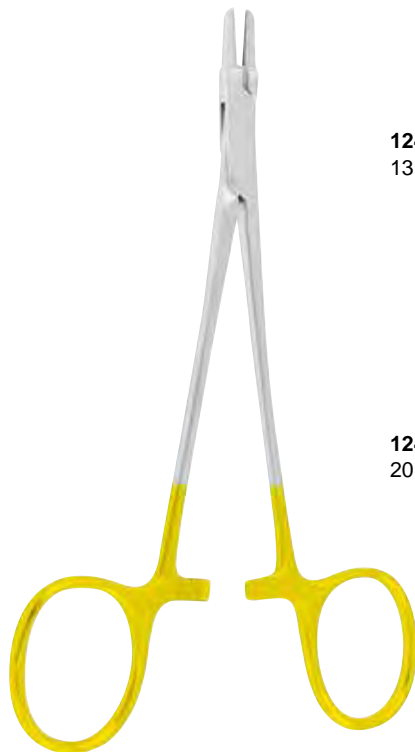
124.214.26
 26,0 cm, 10¹/₄"



124.214.31
 31,0 cm, 12¹/₄"



124.214.37
 37,0 cm, 14¹/₂"



RYDER-VASCULAR



124.222.13
 13,0 cm, 5"



124.222.15
 15,0 cm, 6"



124.222.18
 18,0 cm, 7"



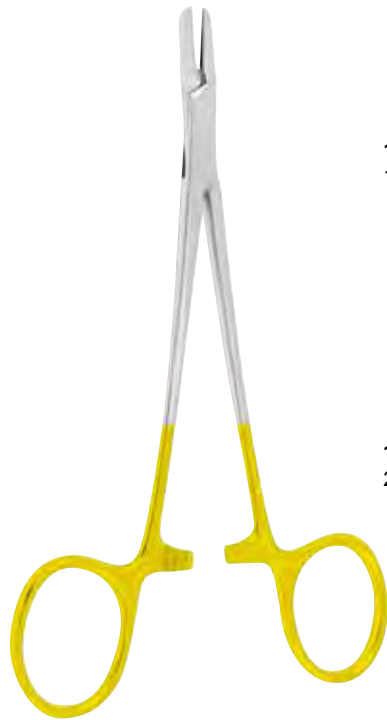
124.222.20
 20,0 cm, 8"



124.222.23
 23,0 cm, 9"



124.222.26
 26,0 cm, 10¹/₄"



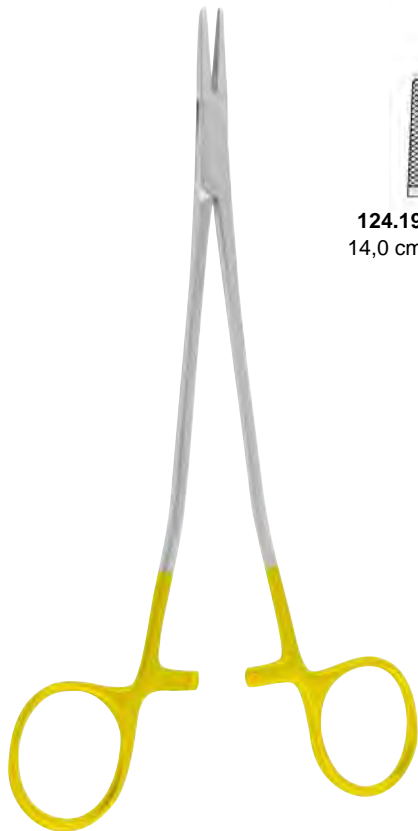
RYDER



SCHWEDISCHES MODELL



Nadelhalter mit Hartmetalleinlagen
 Needle Holders with tungsten carbide inserts
 Porta-agujas con bocas de carburo tungsteno
 Portaghi con morsi in carburo di tungsteno



124.194.14
 14,0 cm, 5½"



124.194.18
 18,0 cm, 7"



124.194.20
 20,0 cm, 8"



MAYO-HEGAR (HEANEY)



FINOCCHIETTO
 27,0 cm, 10½"
124.315.27

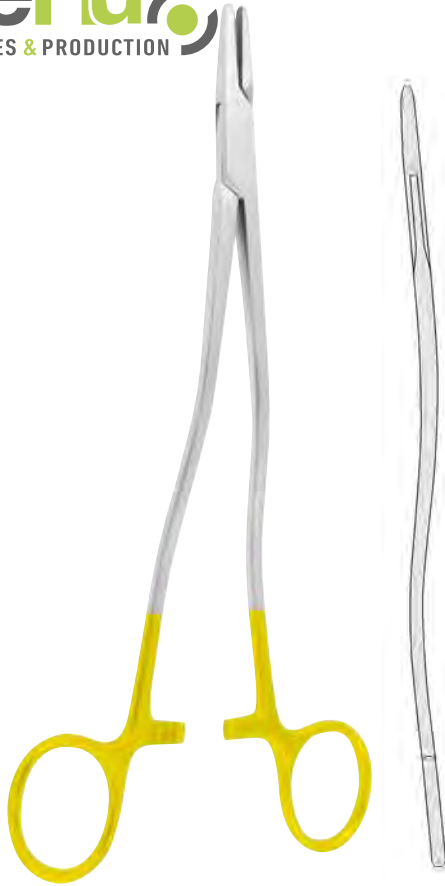


MASSON
 27,0 cm, 10½"
124.254.27

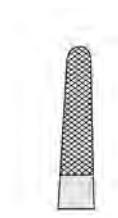


WANGENSTEEN
 27,0 cm, 10½"
124.274.27

Nadelhalter mit Hartmetalleinlagen
Needle Holders with tungsten carbide inserts
Porta-agujas con bocas de carburo tungsteno
Portaghi con morsi in carburo di tungsteno



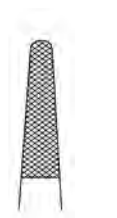
BOZEMANN



124.285.20
20,0 cm, 8"



124.285.24
24,0 cm, 9⁵/₈"



124.285.16
26,0 cm, 10¹/₄"



HEGAR



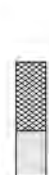
124.184.20
20,0 cm, 8"



124.184.24
24,0 cm, 9⁵/₈"



BARRY STERNAL

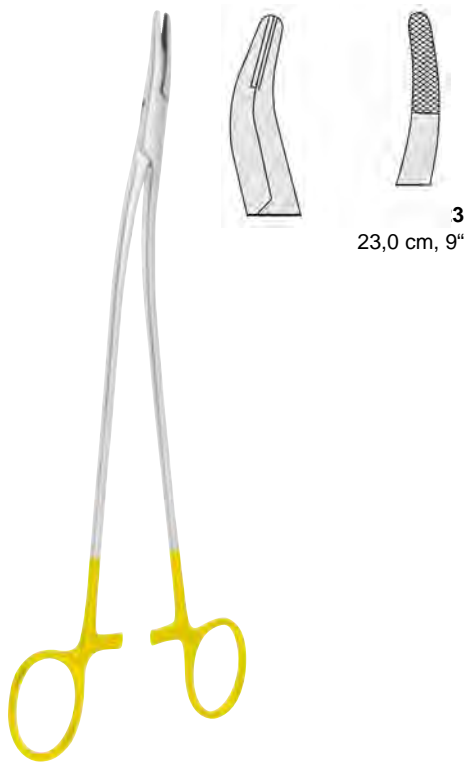


133.600.15
15,0 cm, 6"



133.601.19
20,0 cm, 8"

Nadelhalter mit Hartmetalleinlagen
 Needle Holders with tungsten carbide inserts
 Porta-agujas con bocas de carburo tungsteno
 Portaghi con morsi in carburo di tungsteno



3
 23,0 cm, 9"

STRATTE



GILLIES
 16,0 cm, 6 1/4"
 124.434.16



124.414.14
 14,0 cm, 5 1/2"

124.414.18
 18,0 cm, 7"

OLSEN-HEGAR



TOENNIS
 18,0 cm, 7"
 124.364.18



MATHIEU-KOCHER



124.394.14
14,0 cm, 5½"



124.394.17
17,0 cm, 6¾"



124.394.20
20,0 cm, 8"



MATHIEU



124.374.14
14,0 cm, 5½"



124.374.17
17,0 cm, 6¾"



124.374.20
20,0 cm, 8"

Nadelhalter mit Hartmetalleinlagen
Needle Holders with tungsten carbide inserts
Porta-agujas con bocas de carburo tungsteno
Portaghi con morsi in carburo di tungsteno



124.486.20
20,0 cm, 8"

LICHTENBERG



17,0 cm, 6³/₄"



20,0 cm, 8"



24,5 cm, 9"

MATHIEU



ZWEIFEL



124.496.20
20,0 cm, 8"



124.496.23
23,0 cm, 9"



LANGENBECK



124.492.18
18,0 cm, 7"



124.492.20
20,5 cm, 8"



124.492.23
23,0 cm, 9"

Nadelhalter mit Hartmetalleinlagen
Needle Holders with tungsten carbide inserts
Porta-agujas con bocas de carburo tungsteno
Portaghi con morsi in carburo di tungsteno



124.674.14



124.675.14

mit Sperre
with ratchet
con cremallera
con cremagliera

CASTROVIEJO
14,5 cm, 5³/₄"



124.678.18



124.679.18

mit Sperre
with ratchet
con cremallera
con cremagliera

CASTROVIEJO
18,0 cm, 7"



REVERDIN
15,0 cm



126.201.15



126.202.15



126.203.15



126.204.15



REVERDIN



126.201.19



126.202.19



126.203.19



126.204.19

19,0 cm
23,0 cm

126.201.23

126.202.23

126.203.23

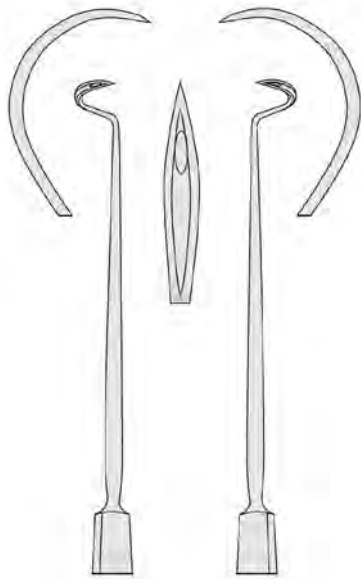
126.204.23

**Unterbindungsadeln
Ligature Needles
Agujas para ligaduras
Aghi per legatura**





scharf
sharp
aguda
acuto

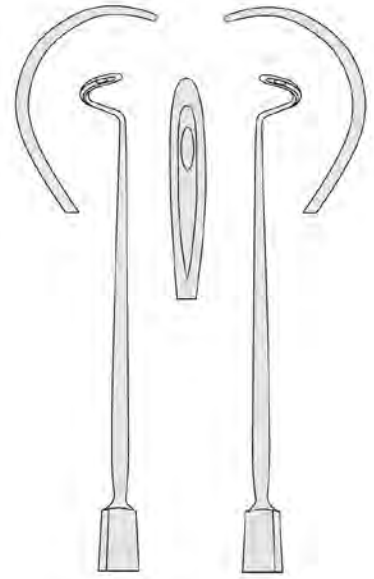


21,0 cm, 8¹/₄" **126.110.21** **126.111.21**
27,0 cm, 10⁵/₈" **126.110.27** **126.111.27**

DESCHAMPS

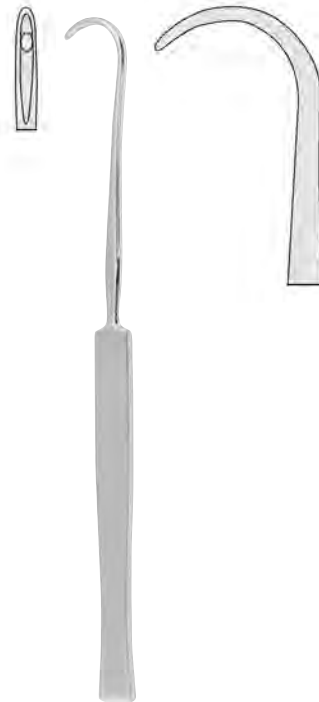


stumpf
blunt
roma
smusso



21,0 cm, 8¹/₄" **126.120.21** **126.121.21**
27,0 cm, 10⁵/₈" **126.120.27** **126.121.27**

DESCHAMPS



COOPER
19,0 cm, 7¹/₂"
126.139.19

Unterbindungsnadeln
Ligature Needles
Agujas para ligaduras
Aghi per legatura



SCHMIEDEN
21,0 cm, 8¹/₄"
126.125.21



YOUNG-HRYNTSCHAK
25,0 cm, 9 1/2"
126.240.00



126.240.01



126.240.02



126.240.03

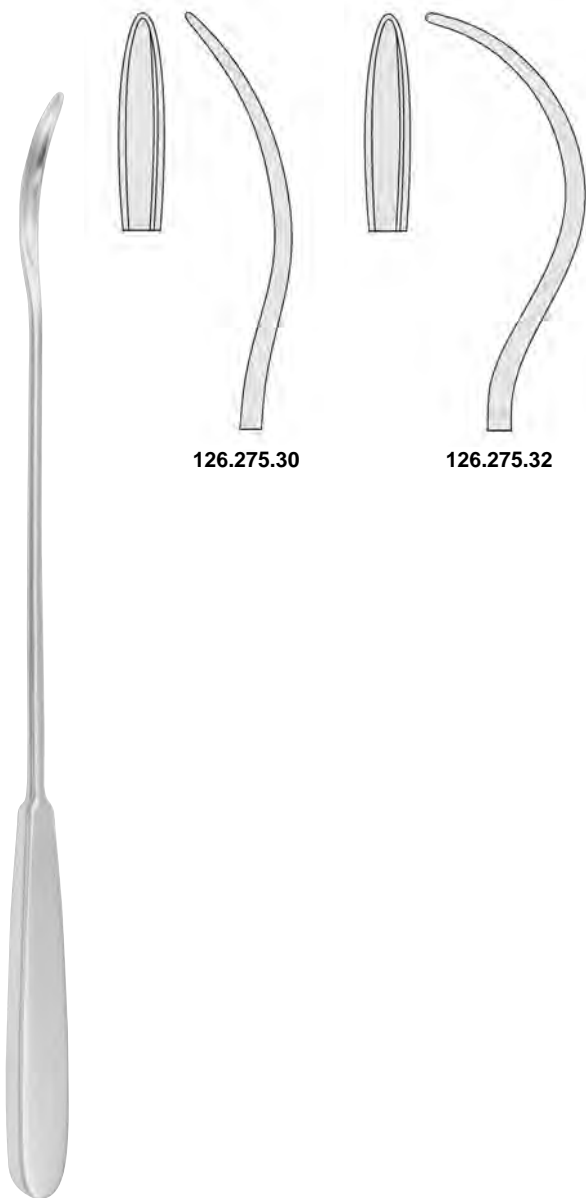


KRONECKER
13,0 cm, 6"
126.130.13

Unterbindungsnadeln
Ligature Needles
Agujas para ligaduras
Aghi per legatura



KRONECKER
13,0 cm, 6"
126.131.13



126.275.30

126.275.32

BRUNNER
30,0 cm, 11³/₄"



PAYR
 22,0 cm, 8⁵/₈"
 126.288.22



PAYR
 22,0 cm, 8⁵/₈"
 126.289.22



mit Loch
 with hole
 con foro
 con ago



SCHMIEDEN-PAYR
 19,0 cm, 7¹/₂"
 126.273.19



ohne Loch
 without hole
 sin foro
 senza ago



SCHMIEDEN
 19,0 cm, 7¹/₂"
 126.271.19



KÖNIG
 19,5 cm, 7³/₄"
 126.283.19



KÖNIG
 19,5 cm, 7³/₄"
 126.285.20



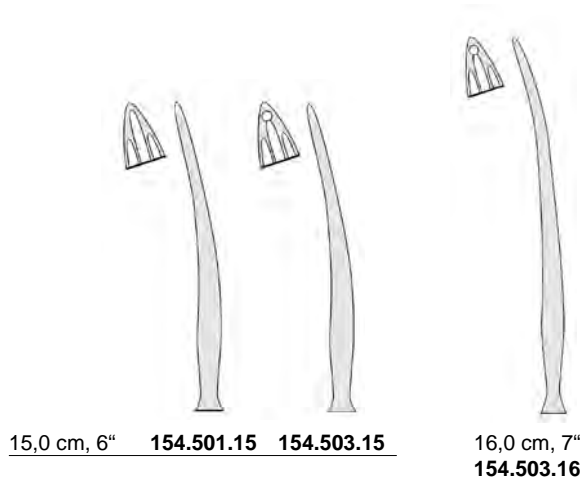
KIRSCHNER



BRUNNER-FERROZELL
18,0 cm, 7" **126.291.18**
27,0 cm, 10⁵/₈" **126.291.27**



KOCHER





MOD. WIEN
23,5 cm, 9¹/₄"
126.535.23



BOZEMANN
21,0 cm, 8¹/₄"
126.532.21



23,0 cm, 9"
126.530.23



MICHEL
12,0 cm, 4³/₄"
126.630.12



COLLIN
13,0 cm, 5"
126.640.13



RICHTER-HEATH
14,0 cm, 5¹/₂"
126.642.14



WACHENFELDT
12,5 cm, 5"
126.614.12



HEGENBARTH
12,5 cm, 5"
126.616.12



MICHEL
12,0 cm, 4³/₄"
126.610.12



LANGE
10,0 cm, 4"
126.618.10



CHILDE CLIP
18,0 cm, 7"
126.620.18



- | | |
|-------------------|---------------|
| 126.660.07 | 7,5 x 1,75 mm |
| 126.660.11 | 11,0 x 2,0 mm |
| 126.660.12 | 12,0 x 3,0 mm |
| 126.660.14 | 14,0 x 3,0 mm |
| 126.660.16 | 16,0 x 3,0 mm |
| 126.660.18 | 18,0 x 3,0 mm |
| 126.660.20 | 20,0 x 3,0 mm |
| 126.660.22 | 22,0 x 3,0 mm |

MICHEL



CLIP-SET
126.670.00

Knochenchirurgie
Bone Surgery
Cirurgía ósea
Chirurgia ossea

Scharfe Löffel
 Bone Curettes
 Cucharillas cortantes
 Curetta per ossa



SCHUDE
 17,0 cm, 6³/₄"



Fig. 000
 132.467.97



Fig. 00
 132.467.98



Fig. 0
 132.468.00



Fig. 1
 132.468.01

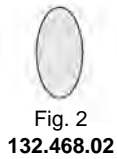


Fig. 2
 132.468.02

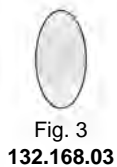


Fig. 3
 132.168.03



Fig. 4
 132.468.04



VOLKMANN
 17,0 cm, 6³/₄"



Fig. 0000
 132.469.96



Fig. 000
 132.469.97



Fig. 00
 132.469.98

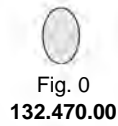


Fig. 0
 132.470.00



Fig. 1
 132.470.01



Fig. 2
 132.470.02

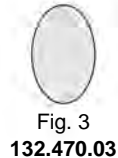


Fig. 3
 132.470.03

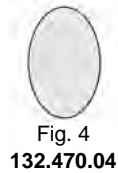


Fig. 4
 132.470.04

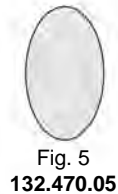


Fig. 5
 132.470.05



Fig. 6
 132.470.06



BRUNS
 17,0 cm, 6³/₄"

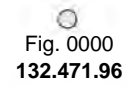


Fig. 0000
 132.471.96

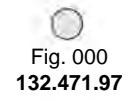


Fig. 000
 132.471.97



Fig. 00
 132.471.98



Fig. 0
 132.472.00

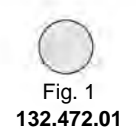


Fig. 1
 132.472.01

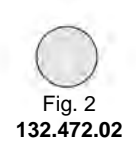


Fig. 2
 132.472.02



Fig. 3
 132.472.03



Fig. 4
 132.472.04



Fig. 5
 132.472.05



Fig. 6
 132.472.06



Fig. 00000
132.490.50



Fig. 0000
132.490.40



Fig. 000
132.490.30



Fig. 00
132.490.20



LEMPERT
21,5 cm, 8½"



Fig. 0
132.490.10



HALLE
21,0 cm, 8¼"



Fig. 01
132.491.01



Fig. 2
132.491.02




Fig. 3
132.491.03



DAUBENSPECK
20,0 cm, 8"



Fig. 00
132.486.99



Fig. 0
132.487.00



Fig. 1
132.487.01



Fig. 2
132.487.02

Scharfe Löffel
 Bone Curettes
 Cucharillas cortantes
 Curetta per ossa



WILLIGER
 17,0 cm, 6³/₄"



Fig. 1
182.821.01



Fig. 2
182.821.02



WILLIGER
 14,0 cm, 5¹/₂"



Fig. 0
132.496.00



Fig. 1
132.496.01

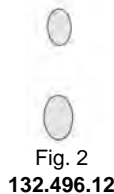


Fig. 2
132.496.12



MARTINI
 14,0 cm, 5¹/₂"



Fig. 00/0
132.498.00
 14,0 cm, 5¹/₂"



Fig. 0/1
132.498.01
 14,0 cm, 5¹/₂"



Fig. 1/2
132.498.12
 14,0 cm, 5¹/₂"



VOLKMANN



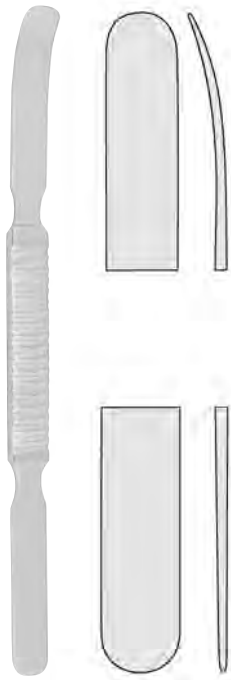
132.494.13
 13,0 cm, 5"



132.494.14
 14,0 cm, 5¹/₂"



132.494.17
 17,0 cm, 6³/₄"



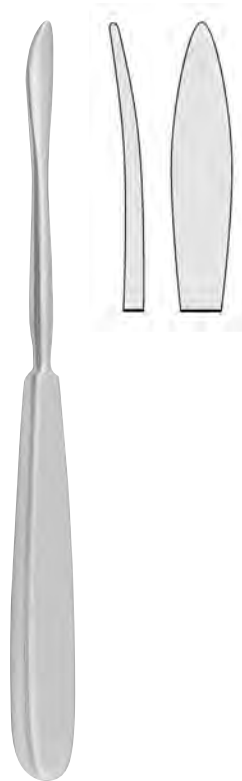
WATSON-CHEYNE
17,5 cm, 6⁷/₈"
132.765.17



MC DONALD
19,0 cm, 7¹/₂"
132.767.19



WILLIGER
16,0 cm, 6³/₄"
132.173.16



LANGENBECK
20,0 cm, 8"
132.751.20



LANGENBECK
20,0 cm, 8"
132.752.20



8 mm
132.754.17



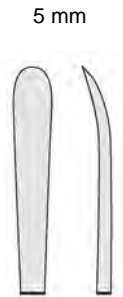
7 mm
132.755.17



7 mm
132.756.17



7 mm
132.757.17



5 mm
KÖNIG
15,5 cm, 6"
132.818.16



10 mm
132.705.10



15 mm
132.705.15

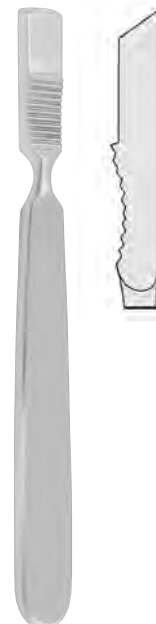


20 mm
132.705.20



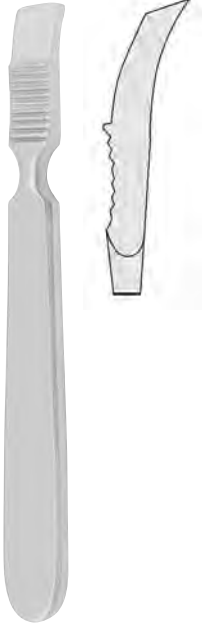
25 mm
132.705.25

12,5 mm



FARABEUF
15,0 cm, 6"
132.702.15

12,5 mm



FARABEUF
15,0 cm, 6"
132.703.15

16,0 mm



LANGENBECK
19,0 cm, 7 1/2"
132.715.01

15,0 mm



SEDILLOT
21,0 cm, 8 1/4"
132.709.21



für Kinder
for children
para niños
per bambini

DOYEN
17,0 cm, 6 3/4"
132.725.17



für Kinder
for children
para niños
per bambini

DOYEN
17,0 cm, 6 3/4"
132.727.17



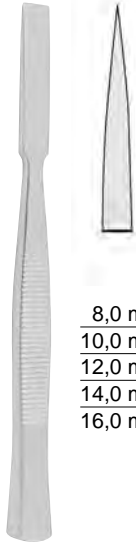
für Erwachsene
for adults
para adultos
per adulti дп

DOYEN
17,0 cm, 6 3/4"
132.721.17



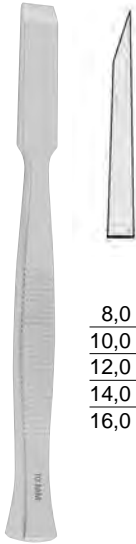
für Erwachsene
for adults
para adultos
per adulti

DOYEN
17,0 cm, 6 3/4"
132.723.17



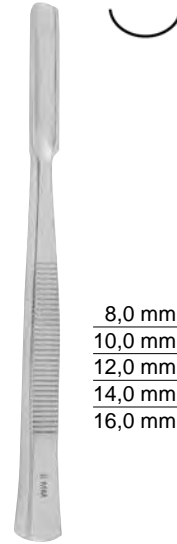
8,0 mm	132.602.08
10,0 mm	132.602.10
12,0 mm	132.602.12
14,0 mm	132.602.14
16,0 mm	132.602.16

13,5 cm, 5³/₈"



8,0 mm	132.604.08
10,0 mm	132.604.10
12,0 mm	132.604.12
14,0 mm	132.604.14
16,0 mm	132.604.16

13,5 cm, 5³/₈"



8,0 mm	132.605.08
10,0 mm	132.605.10
12,0 mm	132.605.12
14,0 mm	132.605.14
16,0 mm	132.605.16

13,5 cm, 5³/₈"



3,0 mm	132.620.03
4,0 mm	132.620.04
5,0 mm	132.620.05
6,0 mm	132.620.06

PARTSCH
 13,5 cm, 5³/₈"



3,0 mm	132.623.03
4,0 mm	132.623.04
5,0 mm	132.623.05
6,0 mm	132.623.06

PARTSCH
 13,5 cm, 5³/₈"



10,0 mm	132.632.10
15,0 mm	132.632.15
20,0 mm	132.632.20
25,0 mm	132.632.25

STILLE
 20,0 cm, 8"



10,0 mm	132.630.10
15,0 mm	132.630.15
20,0 mm	132.630.20
25,0 mm	132.630.25

STILLE
20,0 cm, 8"



10,0 mm	132.633.10
15,0 mm	132.633.15
20,0 mm	132.633.20
25,0 mm	132.633.25

STILLE
20,0 cm, 8"



4,0 mm	132.610.04
6,0 mm	132.610.06
8,0 mm	132.610.08
10,0 mm	132.610.10
12,0 mm	132.610.12
14,0 mm	132.610.14

ALEXANDER
18,0 cm, 7"



4,0 mm	132.611.04
6,0 mm	132.611.06
8,0 mm	132.611.08
10,0 mm	132.611.10
12,0 mm	132.611.12
14,0 mm	132.611.14

ALEXANDER
17,0 cm



6,0 mm	132.634.06
9,0 mm	132.634.09
13,0 mm	132.634.13
16,0 mm	132.634.16
19,0 mm	132.634.19
25,0 mm	132.634.25
32,0 mm	132.634.32

SMITH-PETERSEN
20,0 cm, 8"



6,0 mm	132.635.06
9,0 mm	132.635.09
13,0 mm	132.635.13
16,0 mm	132.635.16
19,0 mm	132.635.19
25,0 mm	132.635.25
32,0 mm	132.635.32

SMITH-PETERSEN
20,0 cm, 8"

Flachmeißel, Hohlmeißel, Osteotome, Hämmer
 Chisels, Gouges, Osteotomes, Mallets
 Cinceles, Gubias, Osteótomos, Martillos
 Scalpelli, Sgorbie, Osteotomi, Martelli



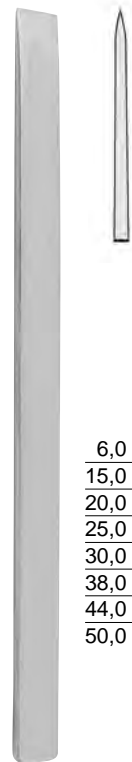
9,0 mm	132.637.09
14,0 mm	132.637.14
16,0 mm	132.637.16
19,0 mm	132.637.19
25,0 mm	132.637.25

SMITH-PETERSEN
 20,0 cm, 8"



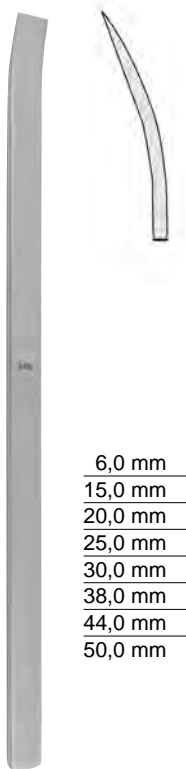
9,0 mm	132.639.09
14,0 mm	132.639.14
16,0 mm	132.639.16
19,0 mm	132.639.19
25,0 mm	132.639.25

SMITH-PETERSEN
 20,0 cm, 8"



6,0 mm	132.650.06
15,0 mm	132.650.15
20,0 mm	132.650.20
25,0 mm	132.650.25
30,0 mm	132.650.30
38,0 mm	132.650.38
44,0 mm	132.650.44
50,0 mm	132.650.50

LAMBOTTE
 24,0 cm, 9 1/2"



6,0 mm	132.651.06
15,0 mm	132.651.15
20,0 mm	132.651.20
25,0 mm	132.651.25
30,0 mm	132.651.30
38,0 mm	132.651.38
44,0 mm	132.651.44
50,0 mm	132.651.50

LAMBOTTE
 24,0 cm, 9 1/2"



Ø 30 mm
 220 g

COLLIN
 20,0 cm, 8"
 132.692.22



Ø 22 mm
 200 g

PARTSCH
 18,0 cm, 7"
 162.694.18

mit Bleifüllung
 lead filled head
 cabezal relleno de plomo
 testa di piombo

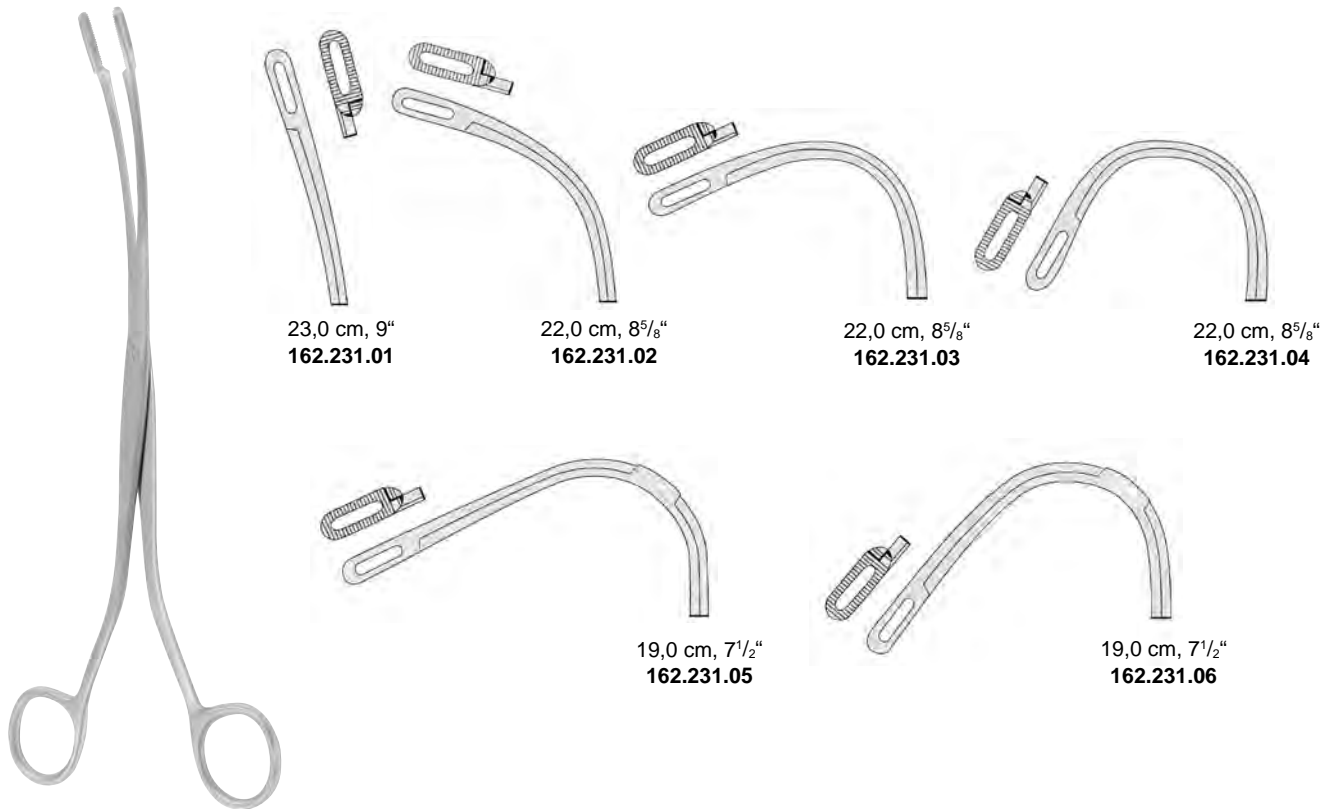


Ø 45 mm
 300 g

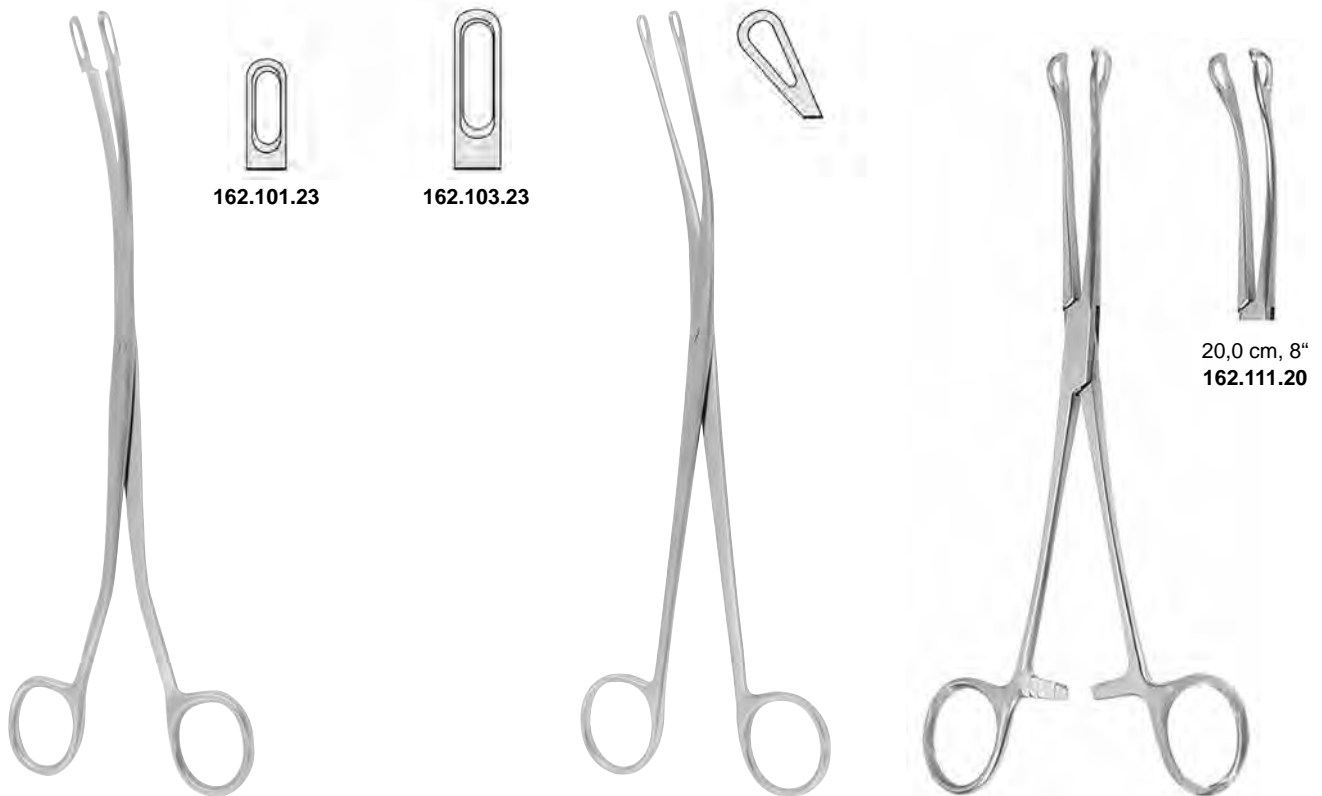
BERGMANN
 24,0 cm, 9 1/2"
 132.695.45

Galle, Leber, Niere, Blase, Urologie
Gall, Liver, Kidney, Bladder, Urology
Bilis, Hígado, Riñon, Vejiga, Urología
Bile, Fegato, Rene, Vescica, Urologia

Nierensteinzangen, Gallensteinzangen
 Kidney Stone Forceps, Gall Stone Forceps
 Pinzas para los cálculos renales, Pinzas para los cálculos biliares
 Pinze per calcoli renali, Pinze per calcoli biliari



RANDALL



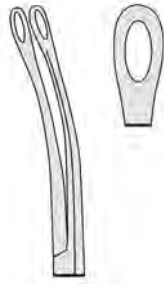
DESJARDINS
 23,0 cm, 9"

MIXTER
 22,0 cm, 8⁵/₈"
 162.117.22

MAYO BLAKE
 20,0 cm, 8"
 162.110.20



BLAKE
20,0 cm, 8"
162.106.20



20,0 cm, 8"
162.107.20



TURNER-WARWICK
18,0 cm, 7"



162.105.19

162.105.18



CZERNY
24,5 cm, 9⁵/₈"
162.105.25



LUER-KÖRTE
 24,0 cm, 9 1/2"



Fig. 000
 2,5 mm
162.190.01



Fig. 00
 3,2 mm
162.190.02



Fig. 2
 6,7 mm
162.190.05



Fig. 3
 8,0 mm
162.190.06

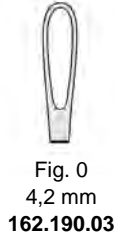


Fig. 0
 4,2 mm
162.190.03



Fig. 1
 5,5 mm
162.190.04



Fig. 4
 11,0 mm
162.190.07

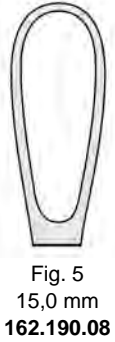


Fig. 5
 15,0 mm
162.190.08



FERGUSSON
 21,5 cm, 8 1/2"
162.170.21



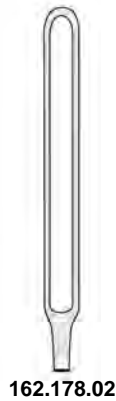
MAYO
 27,0 cm, 10 5/8"
162.175.27



MAYO
 27,0 cm, 10 5/8"



162.178.01



162.178.02



MOYNIHAN
 34,0 cm, 13 3/8"
162.142.34



MAYO
32,0 cm, 12 1/2"
162.210.32



OCHSNER
35,0 cm, 13 3/4"
162.128.32



DESJARDINS
28,0 cm, 11"



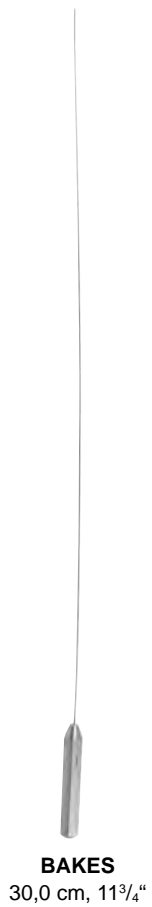
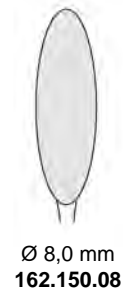
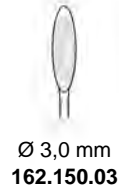
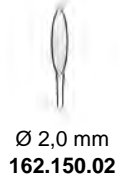
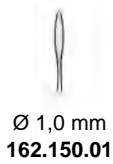
MOORE
28,0 cm, 12"
162.125.25

Gallenblasenlöffel
Gall bladder scoope
Cuccharilla para la vesicula biliar
Cucchiaio per colecisti



DESJARDINS
28,0 cm, 11"



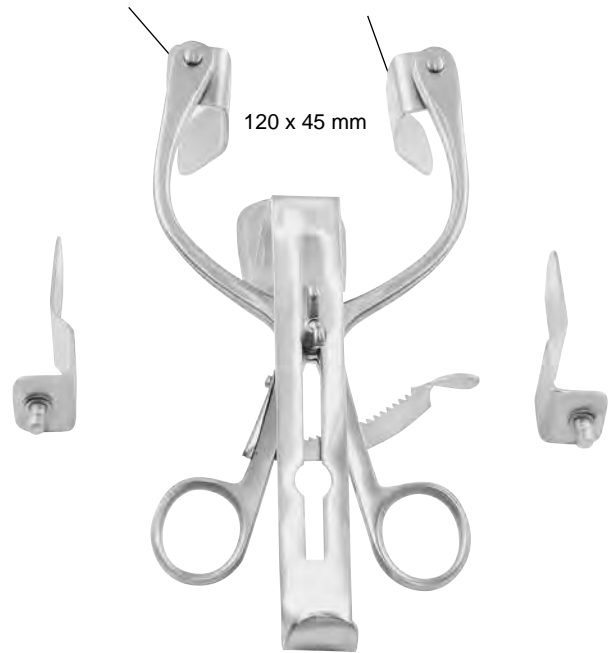




THOMSON-WALKER
166.160.00

2 x
57 x 25 mm

2 x
80 x 25 mm

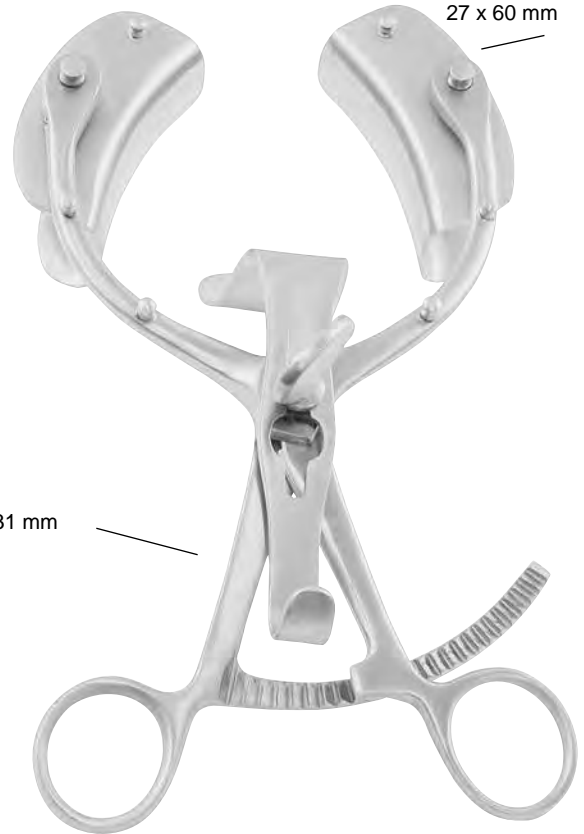


120 x 45 mm

MILLIN
166.151.00

← 95 mm →

27 x 60 mm

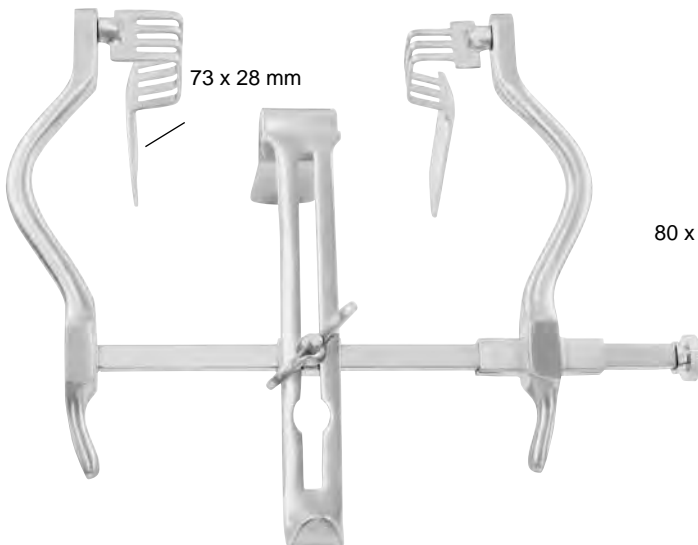


80 x 31 mm

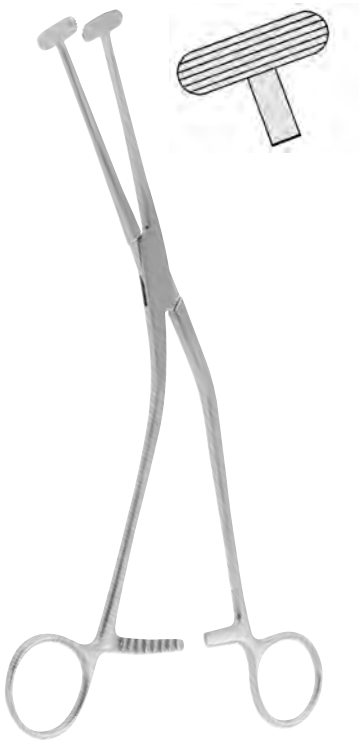
LEGUEU
166.163.00

← 110 mm →

73 x 28 mm



JUDD-MASSON
166.150.00

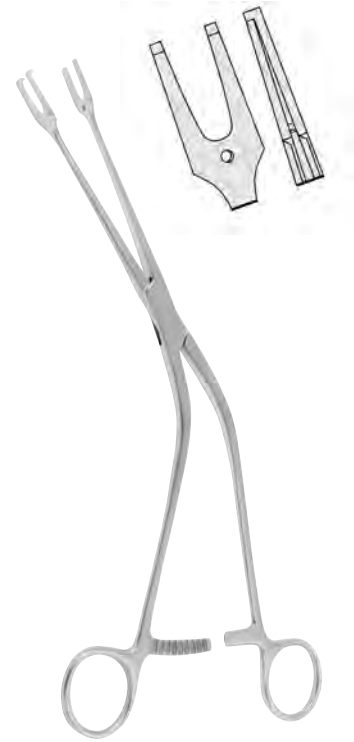


MILLIN
 23,0 cm, 9"
 166.111.23

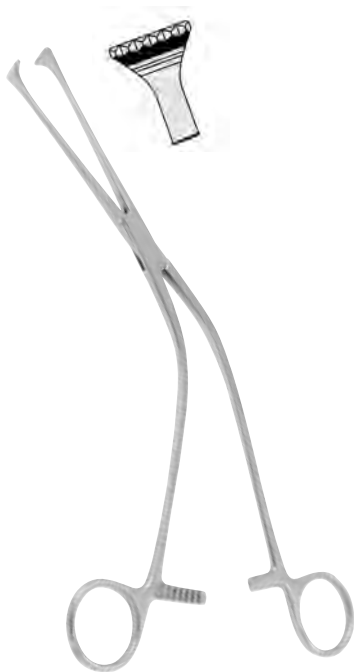


ATRAUMA

MILLIN
 24,5 cm, 9½"
 166.115.24



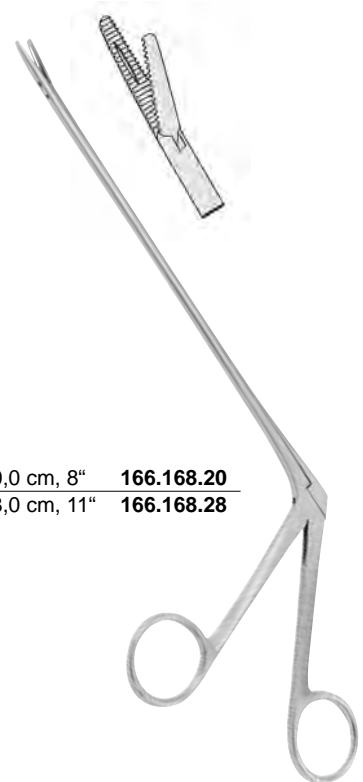
MILLIN
 24,5 cm, 9½"
 166.125.24



MILLIN
 23,0 cm, 9"
 166.123.23



MILLIN
 28,5 cm, 11¼"
 166.165.00



20,0 cm, 8" **166.168.20**
 28,0 cm, 11" **166.168.28**

MATHIEU



YOUNG
21,5 cm, 8¹/₄"
166.101.21



YOUNG
20,5 cm, 8⁵/₈"
166.103.22



YOUNG
22,0 cm, 8¹/₄"
166.105.21



YOUNG
21,5 cm, 8⁵/₈"
166.105.22



90 x 35 mm

LEGUEU
27,0 cm, 10¹/₄"
166.147.27



90 x 61 mm

KOCHER
26,0 cm, 9¹/₄"
166.149.27



für Männer
 for men
 para hombres
 per uomini

Char. 8	166.211.08
Char. 10	166.211.10
Char. 12	166.211.12
Char. 14	166.211.14
Char. 16	166.211.16
Char. 18	166.211.18
Char. 20	166.211.20
Char. 22	166.211.22
Char. 24	166.211.24

29,0 cm, 11¹/₂"



für Frauen
 for women
 para mujeres
 per donne

Char. 8	116.213.08
Char. 10	116.213.10
Char. 12	116.213.12
Char. 14	116.213.14
Char. 16	116.213.16
Char. 18	116.213.18
Char. 20	116.213.20
Char. 22	116.213.20
Char. 24	116.213.24

16,0 cm, 6¹/₄"



STRAUSS
 11,0 cm, 4¹/₃"
166.177.11



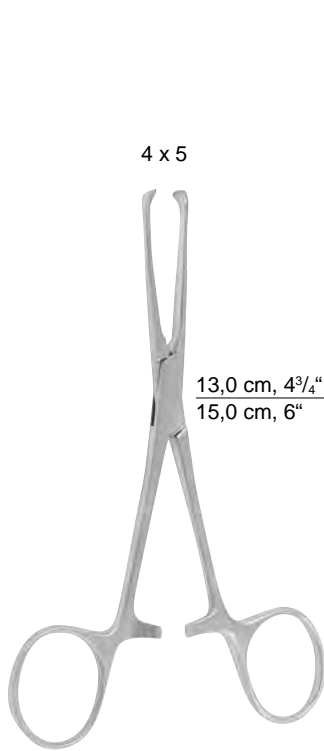
STOCKMANN
 8,0 cm, 3¹/₄"
166.175.08

Ø 8,0 mm	166.171.08
Ø 11,0 mm	166.171.11
Ø 13,0 mm	166.171.13
Ø 16,0 mm	166.171.16
Ø 21,0 mm	166.171.21
Ø 26,0 mm	166.171.26
Ø 32,0 mm	166.171.32



COMCO

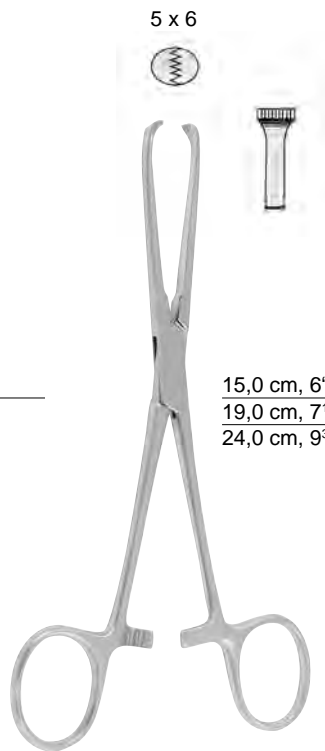
Magen, Darm, Mastdarm
Stomach, Intestines, Rectum
Estómago, Intestino, Recto
Stomaco, Intestino, Retto



4 x 5

13,0 cm, 4³/₄"
 15,0 cm, 6"

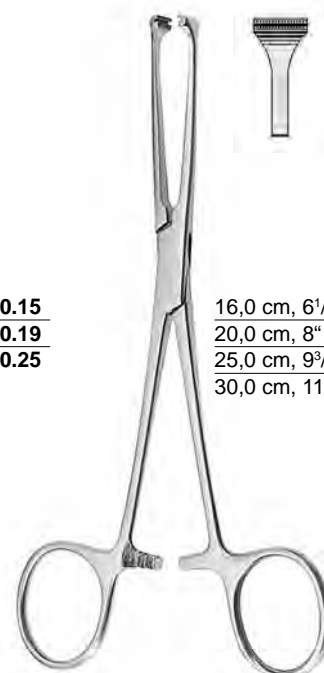
ALLIS-BABY



5 x 6

15,0 cm, 6" **164.120.15**
 19,0 cm, 7¹/₂" **164.120.19**
 24,0 cm, 9³/₄" **164.120.25**

ALLIS



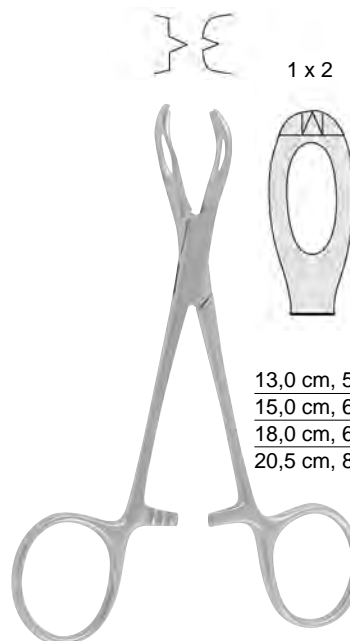
16,0 cm, 6¹/₄" **164.124.16**
 20,0 cm, 8" **164.124.20**
 25,0 cm, 9³/₄" **164.124.25**
 30,0 cm, 11³/₄" **164.124.30**

ALLIS-ATRAUMA



15,5 cm, 6" **164.224.15**
 20,0 cm, 8" **164.224.20**
 25,0 cm, 9" **164.224.25**

ALLEN



1 x 2

13,0 cm, 5" **114.164.13**
 15,0 cm, 6" **114.164.15**
 18,0 cm, 6¹/₂" **114.164.18**
 20,5 cm, 8" **114.164.20**

LANE



15,0 cm, 6" **164.140.15**
19,0 cm, 7½" **164.140.19**

JUDD-ALLIS



LITTLEWOOD
18,5 cm, 7¼"
164.144.19



ALLIS-ADAIR
15,5 cm, 6"
164.130.15



BOYS-ALLIS
15,5 cm, 6"
164.148.15



THOMS-ALLIS
20,0 cm, 8"
164.150.20



LOCKWOOD
 20,0 cm, 8"
 164.188.20



WILLIAMS
 16,5 cm, 6 1/4"
 164.180.16



16,0 cm, 6 1/4" **164.160.16**
 18,0 cm, 7" **164.160.18**
 20,0 cm, 8" **164.160.20**
 24,0 cm, 9 1/2" **164.160.24**



BABCOCK-ATRAUMA

16,0 cm, 6 1/4" **164.168.16**
 20,0 cm, 8" **164.168.20**



BABCOCK-T C

16,0 cm, 6 1/4" **164.164.16**
 20,0 cm, 8" **164.164.20**



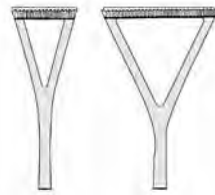
DUVAL-TC
 20,0 cm, 8"
 164.174.20



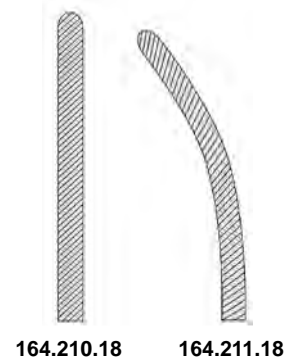
DUVAL

18,0 cm, 7"	164.170.18	
20,0 cm, 8"	164.170.20	164.210.18
23,0 cm, 9"		164.211.18

Darm- und Gewebefaßzangen
Intestinal and Tissue Grasping Forceps
Pinzas intestinales y para tejidos
Pinze da presa per intestino e tessuti



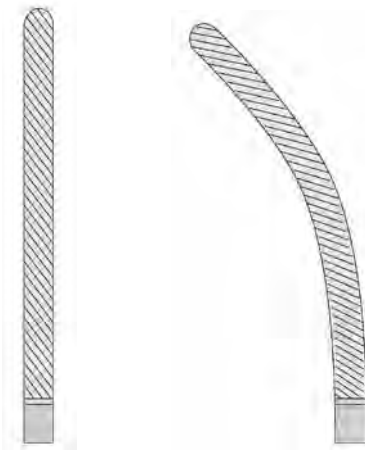
BABY-DOYEN
18,0 cm, 7"



DOYEN

21,0 cm, 8 ¹ / ₄ "	164.210.21
23,0 cm, 9"	164.210.23

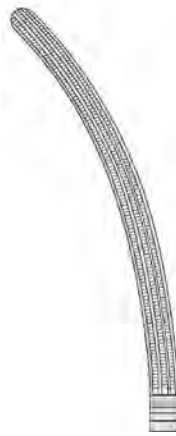
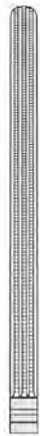
21,0 cm, 8 ¹ / ₄ "	164.211.21
23,0 cm, 9"	164.211.23



Darmklemmen
 Intestinal Clamp Forceps
 Pinzas-clamps intestinales
 Pinze intestinali



DOYEN



16,0 cm	164.216.16	164.217.16
18,0 cm	164.216.18	164.217.18
21,0 cm, 8 ¹ / ₄ "	164.216.21	164.217.21
23,0 cm, 9"	164.216.23	164.217.23

mit atraumatischer Zahnung
 with atraumatic serration
 con bacos atraumáticos
 con morsi atraumatici



KOCHER



22,0 cm, 8 ⁵ / ₈ "	164.220.22	22,0 cm, 8 ⁵ / ₈ "	164.221.22
25,0 cm, 9 ³ / ₄ "	164.220.25	25,0 cm, 9 ³ / ₄ "	164.221.25
28,0 cm, 11"	164.220.28	28,0 cm, 11"	164.221.28



mit atraumatischer Zahnung
with atraumatic serration
con bacos atraumáticos
con morsi atraumatici

KOCHER



22,0 cm, 8 ⁵ / ₈ "	164.226.22	22,0 cm, 8 ⁵ / ₈ "	164.227.22
25,0 cm, 9 ³ / ₄ "	164.226.25	25,0 cm, 9 ³ / ₄ "	164.227.25
28,0 cm, 11"	164.226.28	28,0 cm, 11"	164.227.28

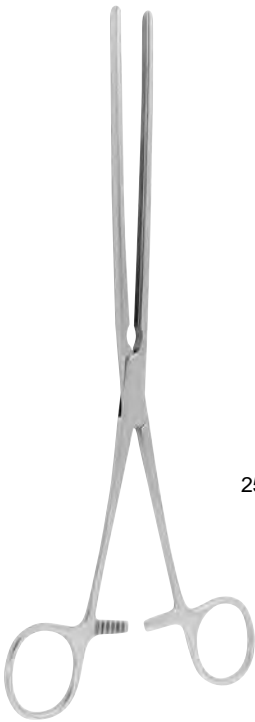


MAYO-ROBSON



23,0 cm, 9"	164.230.23	23,0 cm, 9"	164.231.23
25,0 cm, 9 ³ / ₄ "	164.230.25	25,0 cm, 9 ³ / ₄ "	164.231.25

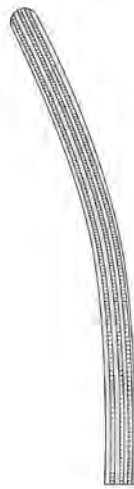
Darmklemmen
 Intestinal Clamp Forceps
 Pinzas-clamps intestinales
 Pinze intestinali



MAYO-ROBSON

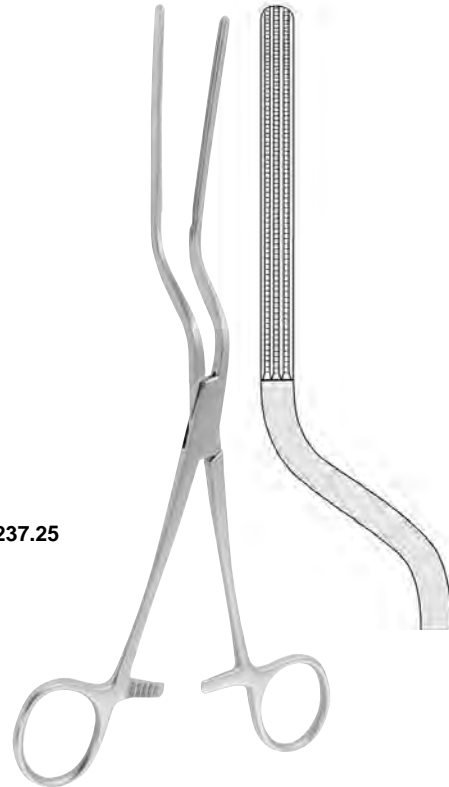


25,0 cm, 9³/₄" **164.236.25**

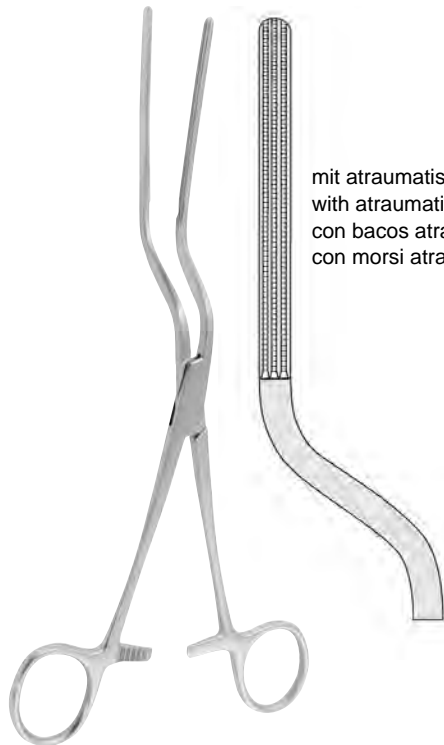


25,0 cm, 9³/₄" **164.237.25**

mit atraumatischer Zahnung
 with atraumatic serration
 con bacos atraumáticos
 con morsi atraumatici

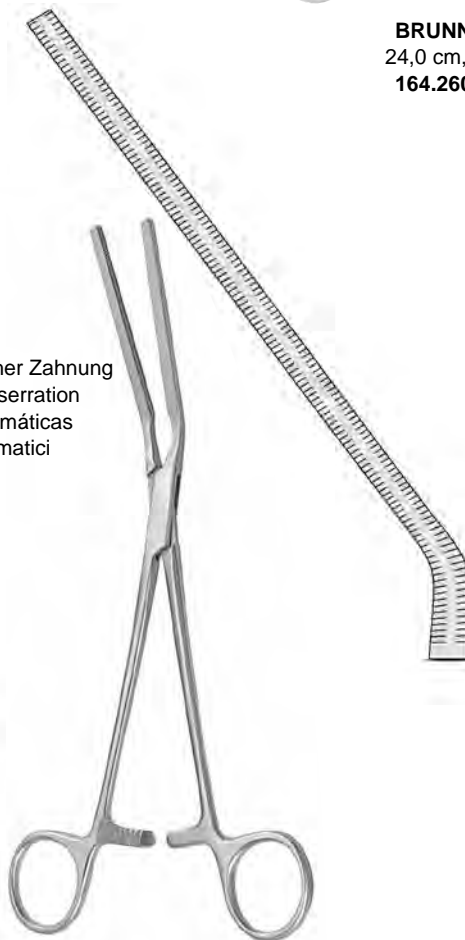


BRUNNER
 24,0 cm, 9¹/₂"
164.260.24

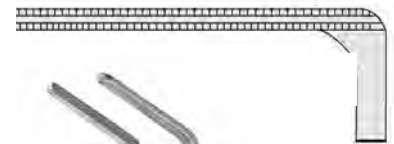


BRUNNER
 24,0 cm, 9¹/₂"
164.266.24

mit atraumatischer Zahnung
 with atraumatic serration
 con bacos atraumáticos
 con morsi atraumatici



GLASSMAN
 23,0 cm, 9"
164.205.23



FEHLAND
 24,0 cm, 9¹/₄"
164.247.23



Maullänge
length of jaws
longitud de la boca
bocche lungh

5,0 cm, 2"	164.280.05
7,0 cm, 2 1/2"	164.280.07
10,0 cm, 4"	164.280.10

DE MARTEL-WOLFSON



DE MARTEL-WOLFSON
8,5 cm, 3 1/2"
164.284.08



DE MARTEL-WOLFSON
26,0 cm, 10 1/4"
164.282.26



164.310.15
mit Stift
with pin
con espiga
con perno



BABY-PAYR
15,0 cm, 6"



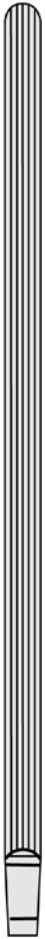
PAYR



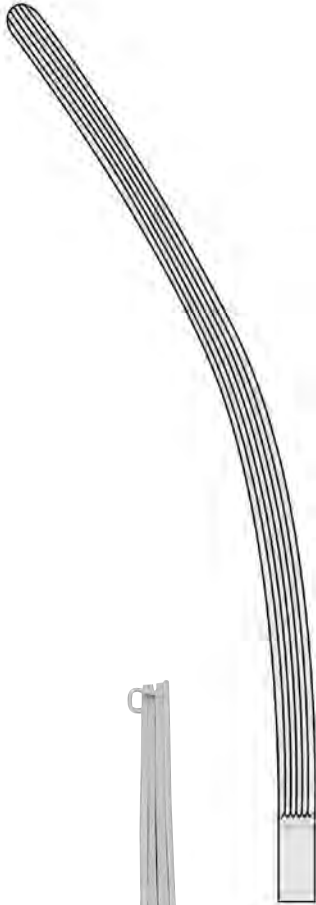
21,0 cm, 8 1/4"	164.310.21
29,0 cm, 11 1/2"	164.310.29
35,0 cm	164.310.35

mit Stift
with pin
con espiga
con perno

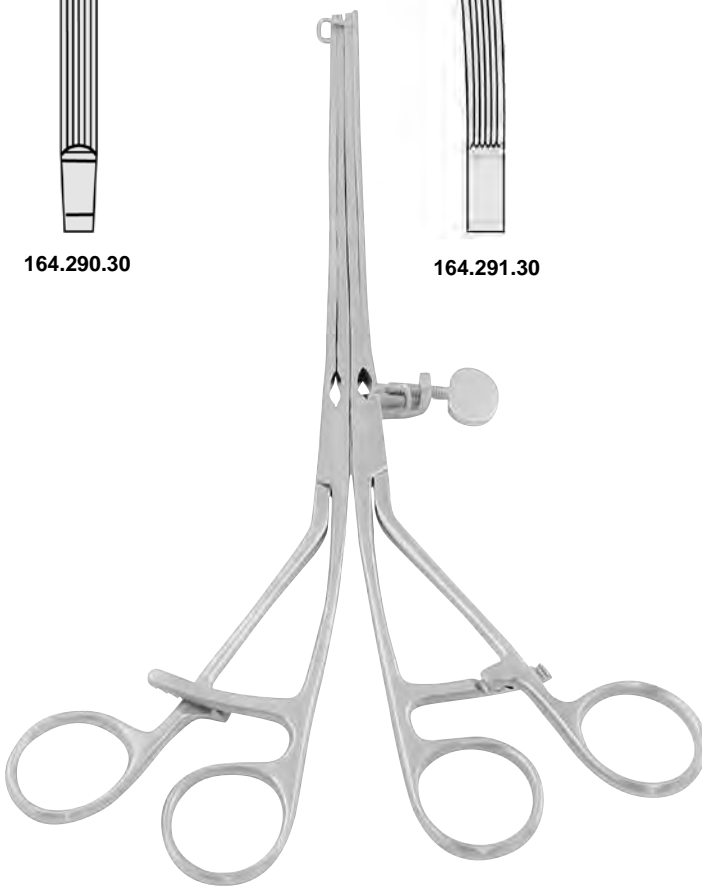
Darm- und Magenklappen
Intestinal and Stomach Clamp Forceps
Pinzas-clamps intestinales y estomacales
Pinze per intestino e stomaco



164.290.30



164.291.30



LANE
30,0 cm, 11³/₄"

Mastdarm-Rektum-Spekula
Rectal Specula
Espéculos para el recto
Speculi rectali

17 x 89 mm



SIMS
15,0 cm, 6"
168.110.15

17 x 89 mm



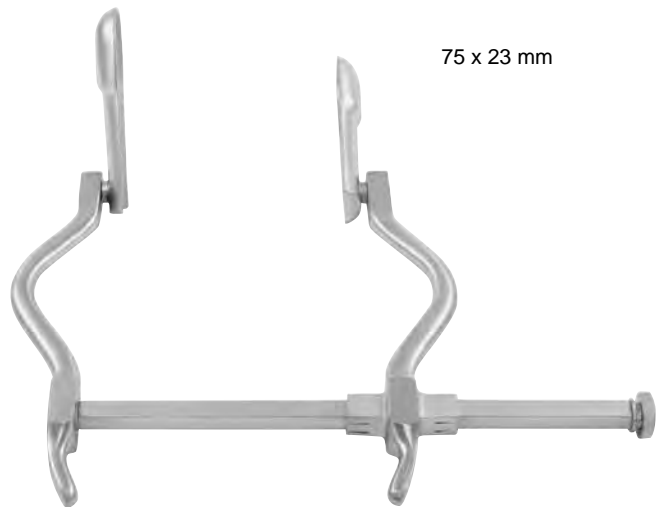
SIMS
15,0 cm, 6"
168.115.15

25 x 89 mm



MATHIEU
19,0 cm
168.130.19

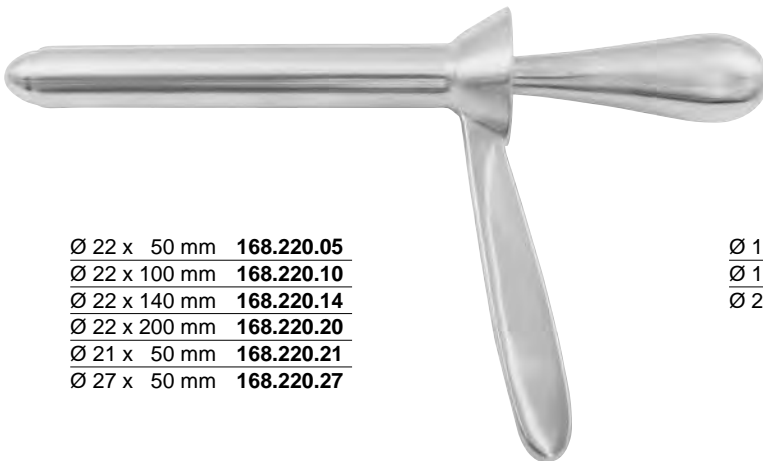
75 x 23 mm



SMITH-BUIE
15,0 cm, 6"
168.150.15

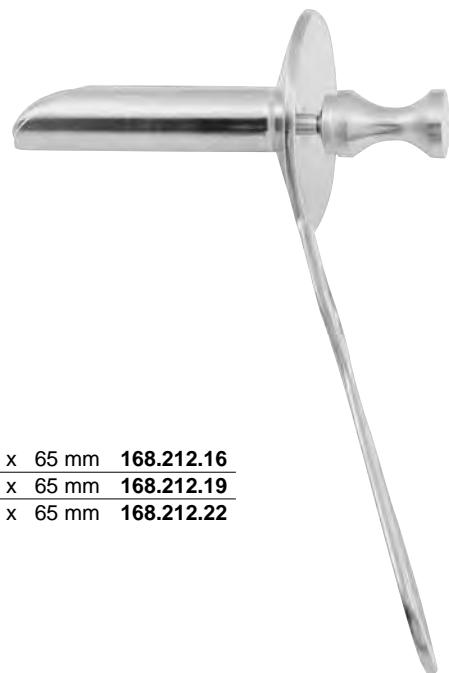


ALAN PARKS
13,5 cm, 5³/₈"
168.147.00



Ø 22 x 50 mm **168.220.05**
Ø 22 x 100 mm **168.220.10**
Ø 22 x 140 mm **168.220.14**
Ø 22 x 200 mm **168.220.20**
Ø 21 x 50 mm **168.220.21**
Ø 27 x 50 mm **168.220.27**

KELLY



Ø 16 x 65 mm **168.212.16**
Ø 19 x 65 mm **168.212.19**
Ø 22 x 65 mm **168.212.22**

HIRSCHMANN

Anuskope, Proktoskope
 Anoscope, Proctoscopes
 Anoscopios, Proctoscopios
 Anoscopi, Proctoscopi



Ø 22 x 65 mm **168.215.22**
 Ø 30 x 65 mm **168.215.30**

CHELSEA EATON

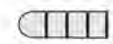


ohne Kaltlichtträger
 without cold light carrier
 sin portador para luz fría
 senza luce fredda

IVES FANSLER
 Ø 22 mm
168.210.22



FANSLER
 Ø 35 x 60 mm **168.185.00**



28,0 cm, 11" **168.301.28**
35,0 cm, 13³/₄" **168.301.35**
42,0 cm, 16¹/₂" **168.301.42**



28,0 cm, 11" **168.302.28**
35,0 cm, 13³/₄" **168.302.35**
42,0 cm, 16¹/₂" **168.302.42**



28,0 cm, 11" **168.303.28**
35,0 cm, 13³/₄" **168.303.35**
42,0 cm, 16¹/₂" **168.303.42**



28,0 cm, 11" **168.304.28**
35,0 cm, 13³/₄" **168.304.35**
42,0 cm, 16¹/₂" **168.304.42**



168.432.12

Ø 12,0 mm

Hämorrhoiden-Ligator mit Ladekonus
Haemorrhoidal ligator with loading attachment
Ligador para hemorroides con cono de carga
Legatori emorroidali con carica a cono

RUDD
168.432.00



168.420.01

Ø 10,0 mm

Hämorrhoiden-Ligator mit Ladekonus
Haemorrhoidal ligator with loading attachment
Ligador para hemorroides con cono de carga
Legatori emorroidali con carica a cono

MC GIVNEY
168.420.00

Hämorrhoiden-Faßzangen, Fistelsonden
Haemorrhoidal Forceps, Fistula probes
Pinza-clamps para hemorroides, Sondas para fistula
Pinze per emorroidi, Sonde per fistola



MC GIVNEY
19,0 cm, 7 1/2"
168.439.19



PRATT
21,0 cm, 8 1/4"



168.251.01



168.251.02



168.251.03

Gynäkologie, Geburtshilfe
Gynecology, Obstetrics
Ginecología, Obstetricia
Ginecologia, Ostetricia

für Jungfrauen
 for virgins
 para vírgenes
 per vergini

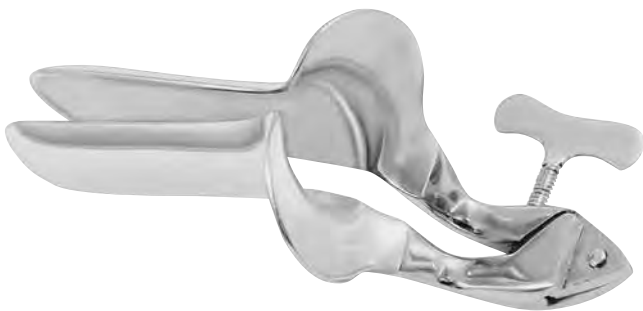


COLLIN
 65 x 20 mm
 170.131.00

für Kinder
 for children
 para niños
 per bambini



COLLIN
 65 x 10 mm
 170.132.00



COLLIN

85 x 30 mm	170.130.01
100 x 35 mm	170.130.02
110 x 40 mm	170.130.03

zentrale Stellschraube
central fixation screw
tornillo de sujeto central
vite di regolazione centrale



CUSCO

75 x 32 mm	170.150.01
85 x 36 mm	170.150.02
95 x 37 mm	170.150.03

seitliche Stellschraube
lateral fixation screw
tornillo de sujeto lateral
vite di regolazione laterale



für Jungfrauen
for virgins
para virgenes
per vergini

CUSCO
75 x 17 mm
170.142.00

seitliche Stellschraube
lateral fixation screw
tornillo de sujeto lateral
vite di regolazione laterale



CUSCO

75 x 32 mm	170.140.01
85 x 35 mm	170.140.02
100 x 35 mm	170.140.03

Schweizer Modell
Swiss pattern
Modelo suizo
Modello svizzero



CUSCO

90 x 23-25 mm	170.160.01
100 x 25-27 mm	170.160.02
110 x 27-30 mm	170.160.03



GRAVE

75 x 20 mm	170.110.01
95 x 35 mm	170.110.02
115 x 35 mm	170.110.03



PEDERSON

75 x 13 mm	170.120.01
100 x 22 mm	170.120.02
120 x 25 mm	170.120.03



SEMM

90 x 14-18 mm	170.190.00
100 x 17-20 mm	170.190.01
100 x 25-30 mm	170.190.02



WEISSBARTH

21,0 cm, 8 ¹ / ₄ "	170.298.00
--	-------------------



mit abnehmbarem Gewicht
with detachable weight
con peso desmontable
con peso smontabile

1,14 kg

AUVARD
75 x 38 mm
170.307.00



mit festem Gewicht
with fixed weight
con peso fijo
con peso fisso

1,14 kg

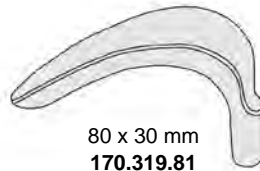
AUVARD
75 x 38 mm
170.309.00



400 g

SCHERBACK
170.319.31

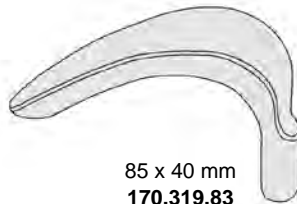
koplett, complete, completo, completo



80 x 30 mm
170.319.81



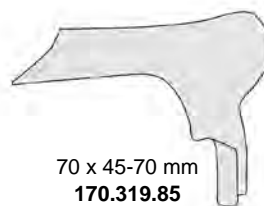
85 x 35 mm
170.319.82



85 x 40 mm
170.319.83



55 x 40-60 mm
170.319.84



70 x 45-70 mm
170.319.85



Satz
 Set
 Juego
 Set

KRISTELLER

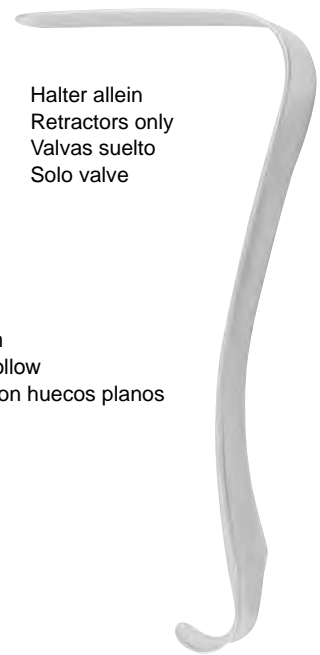
Fig. 1 **170.230.01**
 Fig. 2 **170.230.02**
 Fig. 3 **170.230.03**



Spekula allein, flach
 Specula only, flat hollow
 Espéculos suelto, con huecos planos
 Solo speculi, piatta

KRISTELLER

105 x 26 mm **170.231.01**
 105 x 28 mm **170.231.02**
 105 x 33 mm **170.231.03**



Halter allein
 Retractors only
 Valvas suelto
 Solo valve

KRISTELLER

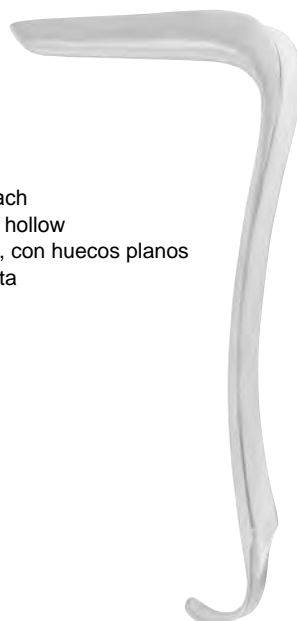
115 x 22 mm **170.232.01**
 115 x 24 mm **170.232.02**
 115 x 29 mm **170.232.03**



Satz
 Set
 Juego
 Set

KRISTELLER

Fig. 1 **170.240.01**
 Fig. 2 **170.240.02**
 Fig. 3 **170.240.03**



Spekula allein, flach
 Specula only, flat hollow
 Espéculos suelto, con huecos planos
 Solo speculi, piatta

KRISTELLER

110 x 27 mm **170.241.01**
 110 x 30 mm **170.241.02**
 110 x 36 mm **170.241.03**



Halter allein
 Retractors only
 Valvas suelto
 Solo valve

KRISTELLER

115 x 23 mm **170.242.01**
 115 x 26 mm **170.242.02**
 115 x 32 mm **170.242.03**



Satz
Set
Juego
Set

KRISTELLER	
Fig. 0	170.244.00
Fig. 1	170.210.01
Fig. 2	170.210.02
Fig. 3	170.210.03



Spekula allein
Specula only
Espéculos suelto
Solo speculi

KRISTELLER	
70 x 15 mm	170.244.01
70 x 27 mm	170.211.01
80 x 30 mm	170.211.02
90 x 36 mm	170.211.03



Halter allein
Retractors only
Valvas suelto
Solo valve

KRISTELLER	
75 x 10 mm	170.244.02
75 x 23 mm	170.212.01
85 x 26 mm	170.212.02
100 x 32 mm	170.212.03



konisch, für Jungfrauen
conical blades, vor virgins
valvos cónicos, para virgenes
valve coniche, per vergini

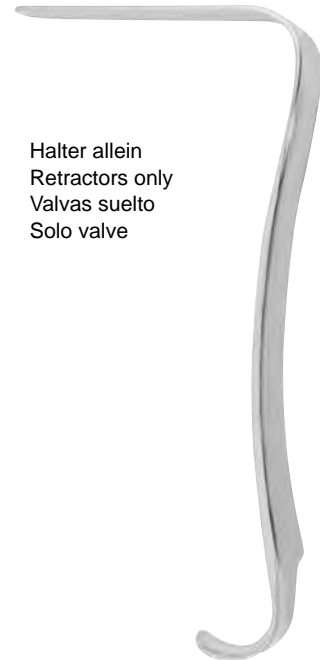
KRISTELLER	
Fig. 00	170.220.01
Fig. 0	170.220.02

Satz
Set
Juego
Set



Spekula allein
Specula only
Espéculos suelto
Solo speculi

KRISTELLER	
105 x 18 mm	170.221.01
105 x 21 mm	170.221.02



Halter allein
Retractors only
Valvas suelto
Solo valve

KRISTELLER	
110 x 14 mm	170.222.01
110 x 17 mm	170.222.02



leicht hohl
slightly-concave
ligeremente concavos
leggeremente concavi

Fig	a x b	
1	55 x 35 mm	170.301.01
2	85 x 35 mm	170.301.02
3	115 x 35 mm	170.301.03
<hr/>		
1	55 x 45 mm	170.303.01
2	85 x 45 mm	170.303.02
3	115 x 45 mm	170.303.03
4	160 x 45 mm	170.303.04
<hr/>		
1	55 x 60 mm	170.305.01
2	85 x 60 mm	170.305.02
3	115 x 60 mm	170.305.03
4	160 x 60 mm	170.305.04

DOYEN
23,0 cm, 9"



Satz
Set
Juego
Set

KALLMORGEN

70 x 40 mm	170.260.01
90 x 40 mm	170.260.02



Spekula allein
Specula only
Espéculos suelto
Solo speculi

KALLMORGEN

70 x 40 mm	170.261.01
90 x 40 mm	170.261.02



Halter allein
Retractors only
Valvas suelto
Solo valve

KALLMORGEN

70 x 40 mm	170.262.01
90 x 40 mm	170.262.02



70 x 15 mm

KRISTELLER

17,0 cm, 6³/₄"
170.244.00



JACKSON

75 x 38 mm	170.271.01
90 x 38 mm	170.271.02
100 x 38 mm	170.271.03

Scheidenspekula
Vaginal Specula
Espéculos vaginales
Speculi vaginali



SIMS
170.291.00
Satz, Set, Juego, Set, набор



70 x 30 mm

65 x 25 mm

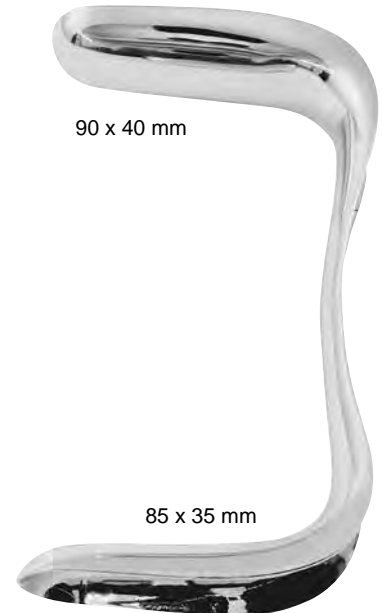
SIMS
12,5 cm, 5"
170.291.01



70 x 35 mm

70 x 30 mm

SIMS
15,0 cm, 6"
170.291.02



90 x 40 mm

85 x 35 mm

SIMS
17,5 cm, 7"
170.291.03



LANDAU

100 x 28 mm	170.319.28
100 x 38 mm	170.319.38



100 x 20 mm	170.310.20
100 x 25 mm	170.310.25
100 x 30 mm	170.310.30
100 x 35 mm	170.310.35
100 x 40 mm	170.310.40
<hr/>	
130 x 20 mm	170.313.20
130 x 25 mm	170.313.25
130 x 30 mm	170.313.30
130 x 35 mm	170.313.35
130 x 40 mm	170.313.40
<hr/>	
155 x 40 mm	170.315.40

BREISKY



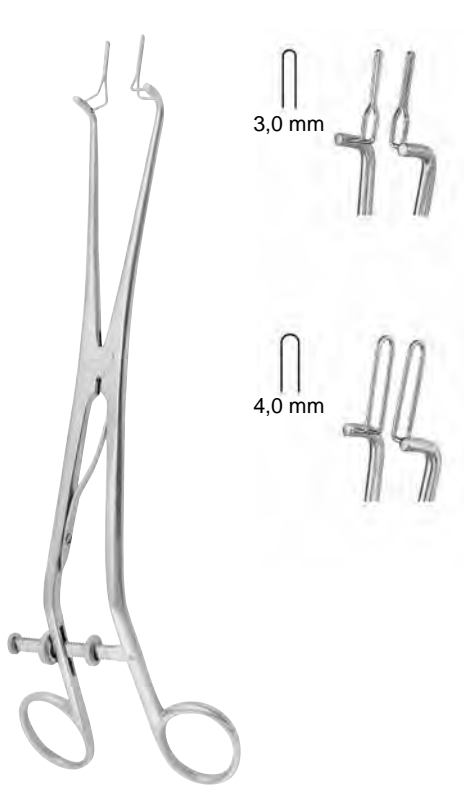
MATZNAUER
 120 x 30 mm
170.299.30



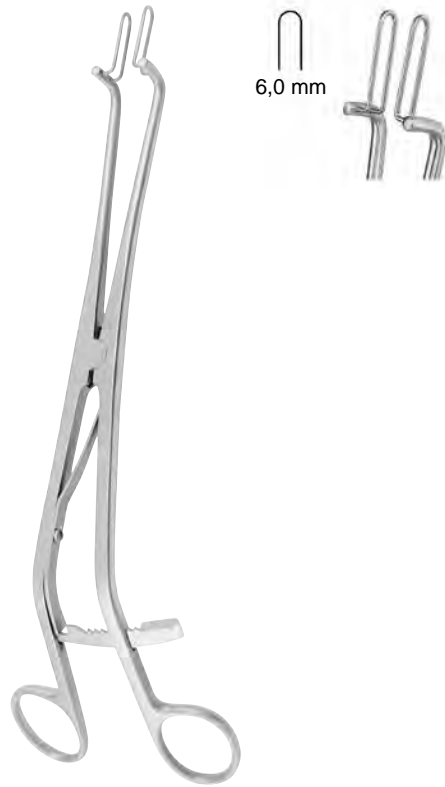
DOYEN
 23,0 cm, 9"
170.300.01



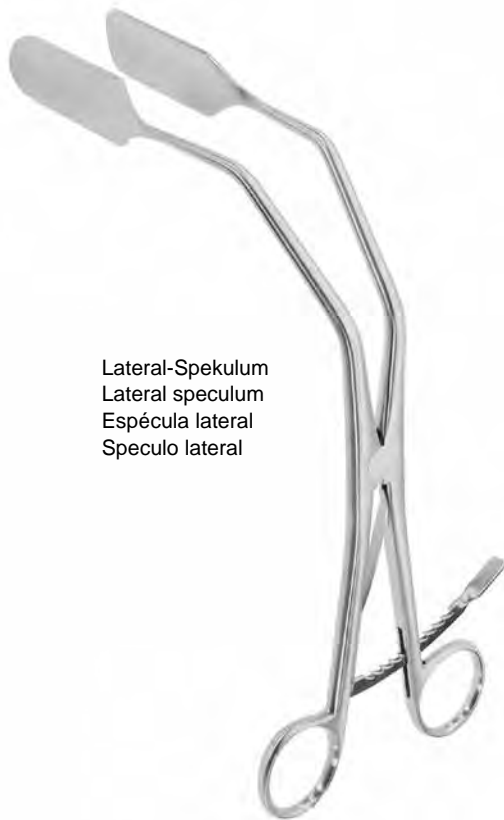
DOYEN
 25,0 cm, 9"
170.300.02



KOGAN
24,0 cm, 9 1/2"
170.360.24



KOGAN
28,0 cm



Lateral-Spekulum
Lateral speculum
Espécula lateral
Speculo lateral

24,0 cm
170.370.24



COHEN
171.316.26



Ø 1,0 mm	170.410.01
Ø 2,0 mm	170.410.02
Ø 3,0 mm	170.410.03
Ø 4,0 mm	170.410.04
Ø 5,0 mm	170.410.05
Ø 6,0 mm	170.410.06
Ø 7,0 mm	170.410.07
Ø 8,0 mm	170.410.08
Ø 9,0 mm	170.410.09
Ø 10,0 mm	170.410.10
Ø 11,0 mm	170.410.11
Ø 12,0 mm	170.410.12
Ø 13,0 mm	170.410.13
Ø 14,0 mm	170.410.14
Ø 15,0 mm	170.410.15
Ø 16,0 mm	170.410.16
Ø 17,0 mm	170.410.17
Ø 18,0 mm	170.410.18
Ø 19,0 mm	170.410.19
Ø 20,0 mm	170.410.20
Ø 21,0 mm	170.410.21
Ø 22,0 mm	170.410.22
Ø 23,0 mm	170.410.23
Ø 24,0 mm	170.410.24
Ø 25,0 mm	170.410.25
Ø 26,0 mm	170.410.26

HEGAR
 18,5 cm, 7 1/4"



Ø 1,5 mm	170.415.01
Ø 2,5 mm	170.415.02
Ø 3,5 mm	170.415.03
Ø 4,5 mm	170.415.04
Ø 5,5 mm	170.415.05
Ø 6,5 mm	170.415.06
Ø 7,5 mm	170.415.07
Ø 8,5 mm	170.415.08
Ø 9,5 mm	170.415.09
Ø 10,5 mm	170.415.10
Ø 11,5 mm	170.415.11
Ø 12,5 mm	170.415.12
Ø 13,5 mm	170.415.13
Ø 14,5 mm	170.415.14
Ø 15,5 mm	170.415.15
Ø 16,5 mm	170.415.16
Ø 17,5 mm	170.415.17

HEGAR
 18,5 cm, 7 1/4"



205 x 105 x 45 mm

HEGAR
170.406.26
 Satz, Set, Juego, Set
 Ø 1,0 - Ø 26,0
 (26 dilators)

HEGAR
170.406.14
 Satz, Set, Juego, Set
 Ø 4,0 - Ø 17,0
 (14 dilators)



HEGAR
20,0 cm, 8"

Ø 1,0 / 2,0 mm	170.420.01
Ø 3,0 / 4,0 mm	170.420.03
Ø 5,0 / 6,0 mm	170.420.05
Ø 7,0 / 8,0 mm	170.420.07
Ø 9,0 / 10,0 mm	170.420.09
Ø 11,0 / 12,0 mm	170.420.11
Ø 13,0 / 14,0 mm	170.420.13
Ø 15,0 / 16,0 mm	170.420.15
Ø 17,0 / 18,0 mm	170.420.17
Ø 19,0 / 20,0 mm	170.420.19
Ø 21,0 / 22,0 mm	170.420.21
Ø 23,0 / 24,0 mm	170.420.23
Ø 25,0 / 26,0 mm	170.420.25



HEGAR
170.425.08
Satz, Set, Juego, Set
Ø 3,0 / 4,0 - Ø 17,0 / 18,0 mm
(8 dilators)

HEGAR
170.424.13
Satz, Set, Juego, Set
Ø 1,0 / 2,0 - Ø 25,0 / 26,0 mm
(13 dilators)



HANK

Ø 4,5 / 5,0 mm	170.430.10
Ø 5,5 / 6,0 mm	170.430.12
Ø 6,5 / 7,0 mm	170.430.14
Ø 7,5 / 8,0 mm	170.430.16
Ø 8,5 / 9,0 mm	170.430.18
Ø 9,5 / 10,0 mm	170.430.20



HANK
170.436.08
Satz, Set, Juego, Set
Ø 4,5 / 5,0 - Ø 9,5 / 10,0 mm
(6 dilators)

Uterus-Dilatatoren, Hakenzangen
 Uterine Dilators, Uterine Tenaculum Forceps
 Dilatadores uterinos, Pinzas para coger el cuello del útero
 Dilattori uterini, Pinze per abbassare il collo del'utero



Ø 13 / 15 CH	170.447.13
Ø 17 / 19 CH	170.447.17
Ø 21 / 23 CH	170.447.21
Ø 25 / 27 CH	170.447.25
Ø 29 / 31 CH	170.447.29
Ø 33 / 35 CH	170.447.33
Ø 37 / 39 CH	170.447.37
Ø 41 / 43 CH	170.447.41

PRATT



PRATT
170.447.08

Satz, Set, Juego, Set
 Ø 4,5 / 5,0 - Ø 13,5 / 14,0 mm
 (8 dilators)



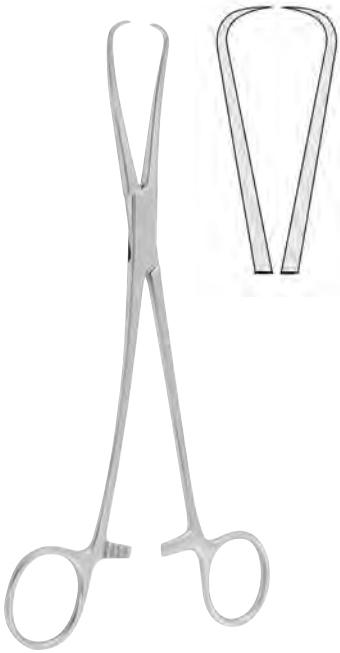
BARRETT
 18,0 cm, 7"
170.510.18



ADAIR
 19,5 cm
112.354.19



STAUDE-MOORE
 17,0 cm, 6¾"
170.508.17



JARCHO
20,0 cm, 8"
170.512.20



SCHROEDER
25,0 cm, 9³/₄"
170.502.25



BRAUN
25,0 cm, 9³/₄"
170.504.25



DUPLAY
28,0 cm, 11"
170.507.28



POZZI
25,0 cm
170.506.25



KAHN
24,0 cm, 9¹/₂"
170.503.24

Hakenzangen
Uterine Tenaculum Forceps
Pinzas para coger el cuello del útero
Pinze per abbassare il collo dell'utero



SKENE
24,0 cm, 9½"
170.505.24



SCHROEDER
24,0 cm, 9½"
170.514.24



SCHROEDER
24,0 cm, 9½"
170.515.24



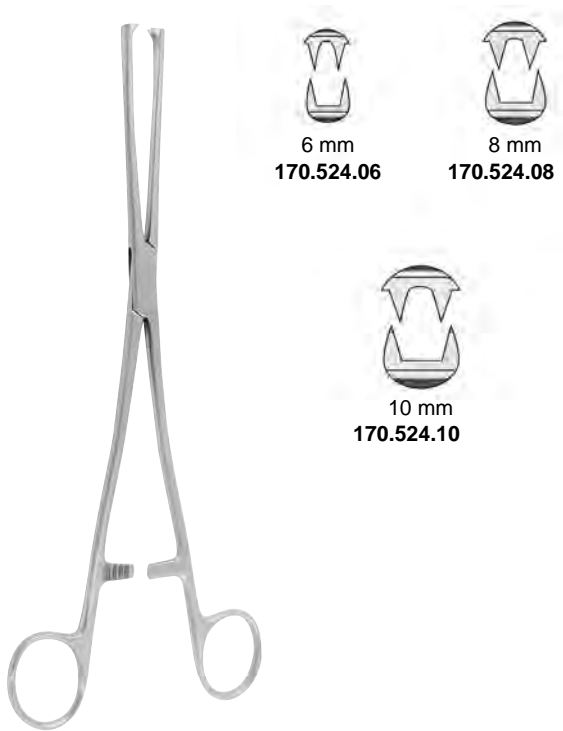
TEALE
23,0 cm, 9"
170.531.23



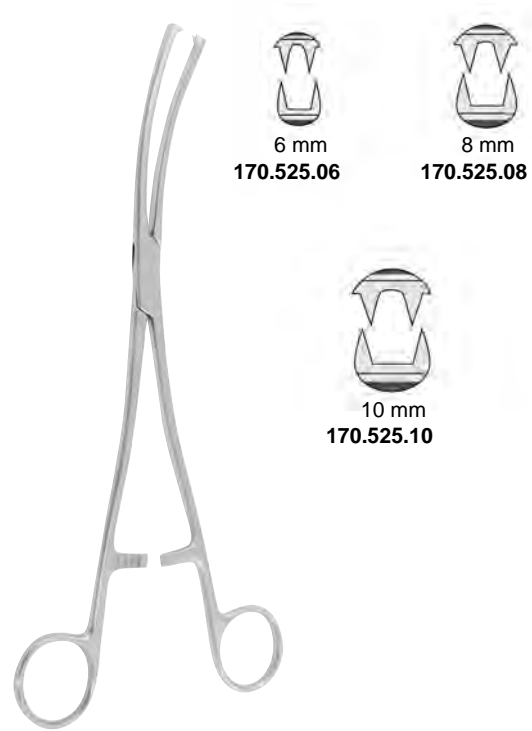
JACOBS
21,0 cm, 8½"
170.532.21



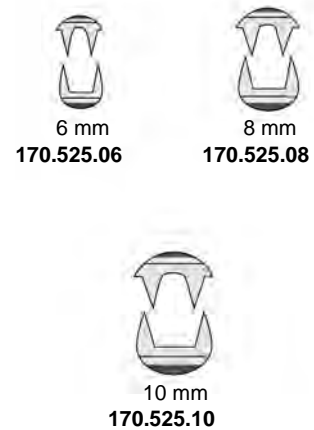
JACOBS
21,0 cm, 8½"
170.533.21



MUSEUX
24,0 cm, 9½"

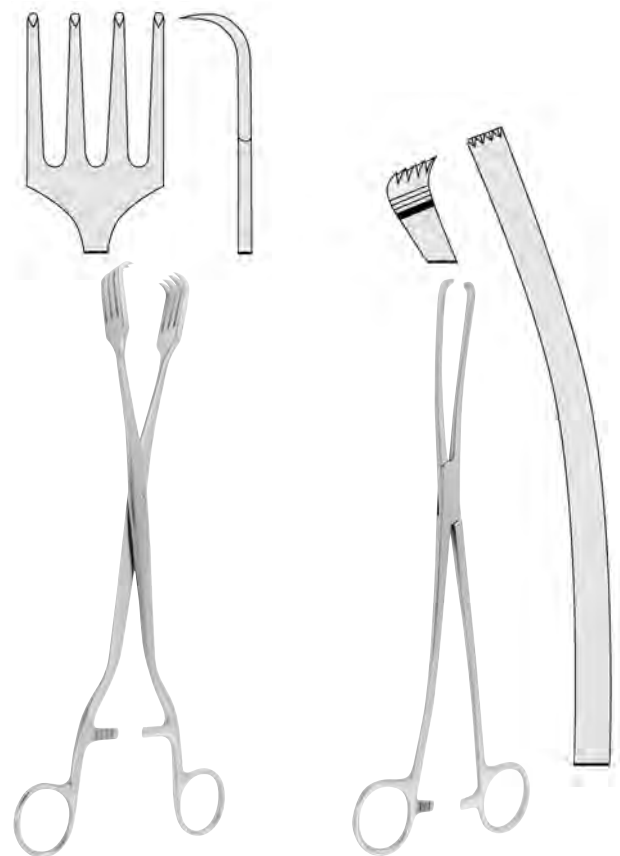


MUSEUX
24,0 cm, 9½"



BRAUN
15,5 cm, 6"
170.539.15

CZERNY
20,5 cm, 8"
170.537.21



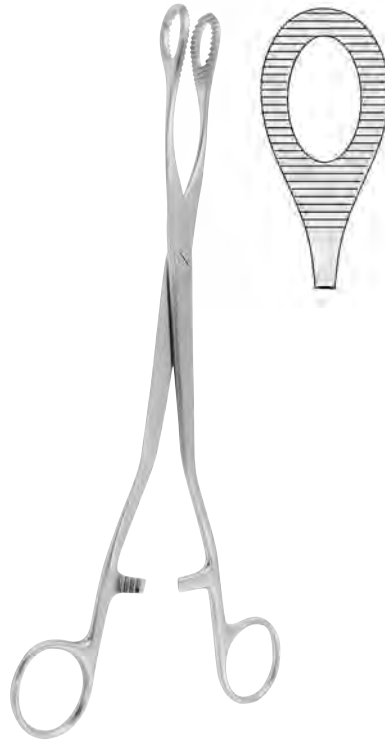
PRATT
28,0 cm, 11"
170.536.28

IOWA
26,0 cm, 10¼"
170.539.26

Polypen- und Ovarienzangen, Uterusfaßzangen
 Polypus and Ovum Forceps, Uterine Elevating Forceps
 Pinzas para pólipos uterinos y ovarios, Pinzas para la útero
 Pinze per polipi e ovaie, Pinze per affarrare l'utero



DOYEN
 20,0 cm
 170.542.20



NOTO
 27,0 cm, 10⁵/₈"
 170.540.27



KELLY
 32,0 cm, 12¹/₂"
 170.543.32



HEYWOOD-SMITH
 25,0 cm, 9³/₄"
 168.402.25



DARTIGUES
 27,0 cm, 10³/₄"
 170.545.27



SOMER
 23,0 cm, 9"
 170.547.23



COLLIN
25,0 cm, 9³/₄"
170.549.25



BEACHAM
26,0 cm, 10¹/₄"
170.559.26

Amniotom
Amniotome
Amniótomo
Amniotomo



BRAUN
28,0 cm, 11"
170.565.28

Uterus-Depressor
Uterine depressor
Depresor uterino
Depressori uterini



SIMS
32,0 cm, 12¹/₂"
170.580.32



SIMS
32,0 cm, 12¹/₂"
170.581.32

biegsam
malleable
maleable
malleabile



MARTIN
32,0 cm, 12¹/₂"
170.582.32



MARTIN
32,0 cm, 12¹/₂"
170.583.32

biegsam
malleable
maleable
malleabile



VALLEIX
25,0 cm, 10"
170.585.25



SIMPSON
29,0 cm, 11¹/₂"
170.581.29

Ø 4 mm

biegsam
malleable
maleable
malleabile



COLLIN
28,0 cm, 11"
170.584.28

Ø 4 mm

Biopsieküretten
Biopsy Currettes
Curetas para biopsia
Curette per biopsia

VeHu
SALES & PRODUCTION



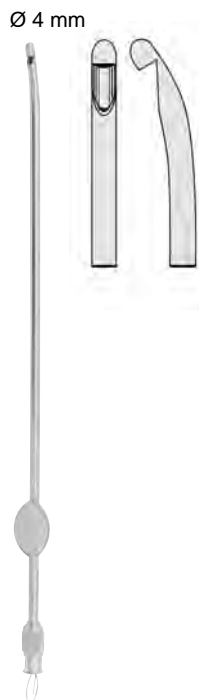
KEVORKIAN
30,0 cm, 12"
170.593.40



KEVORKIAN
30,0 cm, 12"
170.594.40



NOVAK
23,0 cm, 9"
170.592.04



RANDALL
23,0 cm, 9"
170.590.04



24,0 cm
168.253.24



EMMETT
22,0 cm, 8⁵/₈"



170.645.01



170.645.02



170.645.03



170.645.04



170.645.05



SEGOND
27,0 cm, 10⁵/₈"
170.643.27



DOYEN
19,0 cm, 7¹/₂"
170.641.19



DOYEN
17,0 cm, 6³/₄"
170.641.17



5 mm
 Fig. 00



6 mm
 Fig. 0



7 mm
 Fig. 1



8 mm
 Fig. 2



9 mm
 Fig. 3



11 mm
 Fig. 4



12 mm
 Fig. 5



14 mm
 Fig. 6



15 mm
 Fig. 7



16 mm
 Fig. 8



19 mm
 Fig. 9



20 mm
 Fig. 10



21 mm
 Fig. 11



23 mm
 Fig. 12



scharf, fest
 sharp, rigid
 cortantes, rígidas
 acute, rigide

Fig. 00	170.720.05
Fig. 0	170.720.06
Fig. 1	170.720.07
Fig. 2	170.720.08
Fig. 3	170.720.09
Fig. 4	170.720.11
Fig. 5	170.720.12
Fig. 6	170.720.14
Fig. 7	170.720.15
Fig. 8	170.720.16
Fig. 9	170.720.19
Fig. 10	170.720.20
Fig. 11	170.720.21
Fig. 12	170.720.23

RECAMIER
 31,0 cm



scharf, biegsam
 sharp, malleable
 cortantes, maleable
 acute, malleabile

Fig. 00	170.725.05
Fig. 0	170.725.06
Fig. 1	170.725.07
Fig. 2	170.725.08
Fig. 3	170.725.09
Fig. 4	170.725.11
Fig. 5	170.725.12
Fig. 6	170.725.14
Fig. 7	170.725.15
Fig. 8	170.725.16
Fig. 9	170.725.19
Fig. 10	170.725.20
Fig. 11	170.725.21
Fig. 12	170.725.23

RECAMIER
 31,0 cm



5 mm
Fig. 00



6 mm
Fig. 0



7 mm
Fig. 1



8 mm
Fig. 2



9 mm
Fig. 3



11 mm
Fig. 4



12 mm
Fig. 5



14 mm
Fig. 6



15 mm
Fig. 7



16 mm
Fig. 8



19 mm
Fig. 9



20 mm
Fig. 10



21 mm
Fig. 11



23 mm
Fig. 12



SIMS
28,0 cm

scharf, fest
sharp, rigid
cortantes, rígidas
acute, rigide

Fig. 00	170.710.05
Fig. 0	170.710.06
Fig. 1	170.710.07
Fig. 2	170.710.08
Fig. 3	170.710.09
Fig. 4	170.710.11
Fig. 5	170.710.12
Fig. 6	170.710.14



SIMS
28,0 cm

scharf, biegsam
sharp, malleable
cortantes, maleable
acute, malleabile

Fig. 00	170.715.05
Fig. 0	170.715.06
Fig. 1	170.715.07
Fig. 2	170.715.08
Fig. 3	170.715.09
Fig. 4	170.715.11
Fig. 5	170.715.12
Fig. 6	170.715.14



5 mm
 Fig. 00



6 mm
 Fig. 0



7 mm
 Fig. 1



8 mm
 Fig. 2



9 mm
 Fig. 3



11 mm
 Fig. 4



12 mm
 Fig. 5



14 mm
 Fig. 6



15 mm
 Fig. 7



16 mm
 Fig. 8



19 mm
 Fig. 9



20 mm
 Fig. 10



21 mm
 Fig. 11



23 mm
 Fig. 12



stumpf, fest
 blunt, rigid

Fig. 00	170.722.05
Fig. 0	170.722.06
Fig. 1	170.722.07
Fig. 2	170.722.08
Fig. 3	170.722.09
Fig. 4	170.722.11
Fig. 5	170.722.12
Fig. 6	170.722.14
Fig. 7	170.722.15
Fig. 8	170.722.16
Fig. 9	170.722.19
Fig. 10	170.722.20
Fig. 11	170.722.21
Fig. 12	170.722.23

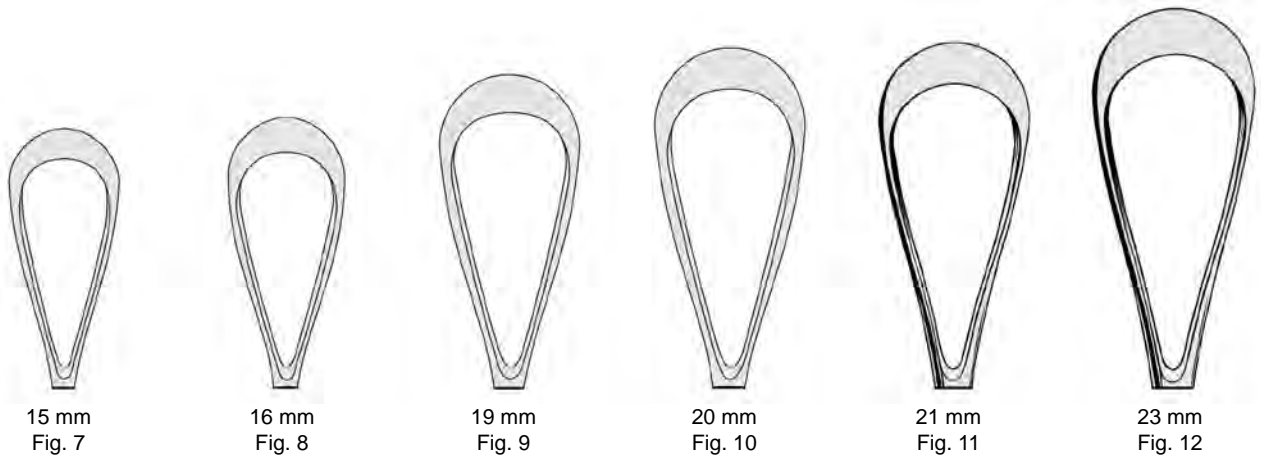
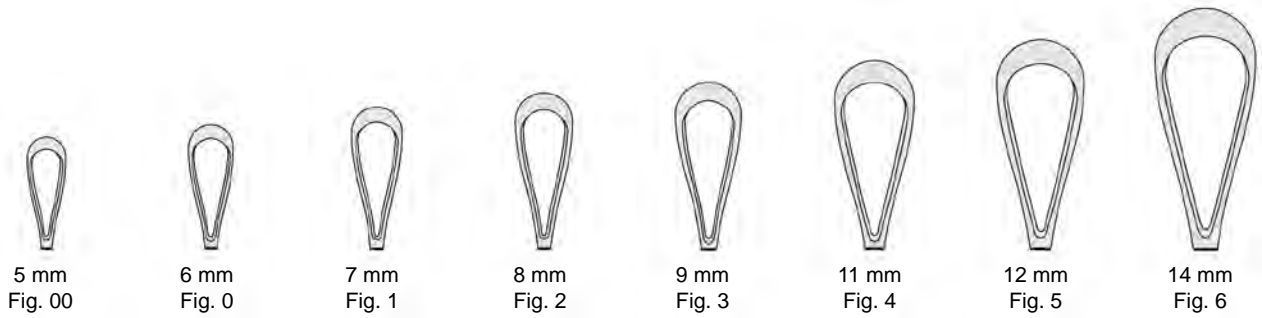
RECAMIER
 31,0 cm, 12¹/₄"



stumpf, biegsam
 blunt, malleable

Fig. 00	170.727.05
Fig. 0	170.727.06
Fig. 1	170.727.07
Fig. 2	170.727.08
Fig. 3	170.727.09
Fig. 4	170.727.11
Fig. 5	170.727.12
Fig. 6	170.727.14
Fig. 7	170.727.15
Fig. 8	170.727.16
Fig. 9	170.727.19
Fig. 10	170.727.20
Fig. 11	170.727.21
Fig. 12	170.727.23

RECAMIER
 31,0 cm, 12¹/₄"



SIMS
28,0 cm

stumpf
blunt

Fig. 00	170.712.05
Fig. 0	170.712.06
Fig. 1	170.712.07
Fig. 2	170.712.08
Fig. 3	170.712.09
Fig. 4	170.712.11
Fig. 5	170.712.12
Fig. 6	170.712.14



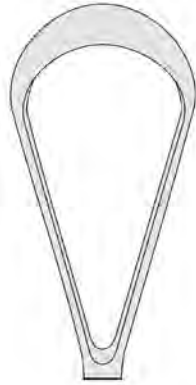
SIMS
28,0 cm

stumpf
blunt

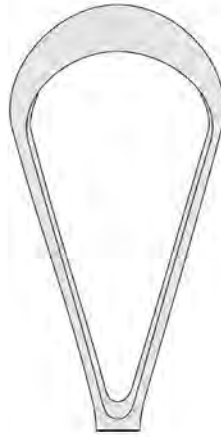
Fig. 00	170.717.05
Fig. 0	170.717.06
Fig. 1	170.717.07
Fig. 2	170.717.08
Fig. 3	170.717.09
Fig. 4	170.717.11
Fig. 5	170.717.12
Fig. 6	170.717.14

Uterusküretten
Uterine Curettes
Curetas uterinas
Curette uterine

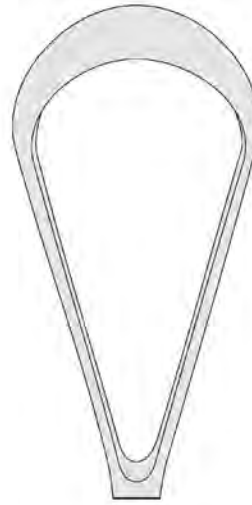




30 mm
Fig. 1



35 mm
Fig. 2



40 mm
Fig. 3



scharf, fest
sharp, rigid
cortantes, rígidas
acute, rigide

Fig. 1 **170.730.30**
Fig. 2 **170.730.35**
Fig. 3 **170.730.40**

BUMM
34,0 cm, 12¹/₄"



scharf, biegsam
sharp, malleable
cortantes, maleable
acute, malleabile

Fig. 1 **170.735.30**
Fig. 2 **170.735.35**
Fig. 3 **170.735.40**

BUMM
34,0 cm, 12¹/₄"

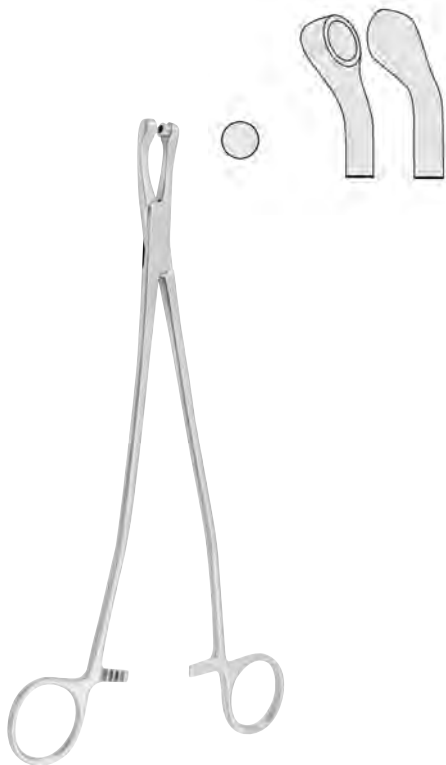
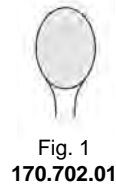
Uteruslöffel, Uterus-Biopsiezangen
Uterine Scoopes, Cervical Biopsy and Specimen Forceps
Cucharillas uterinas, Pinzas saca-bocados para biopsia
Curette uterine, Pinze per la biopsia cervicale e da prelievo



BLAKE
 27,0 cm, 10⁵/₈"
170.704.27



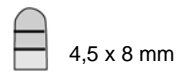
SIMON
 25,0 cm, 9³/₄"

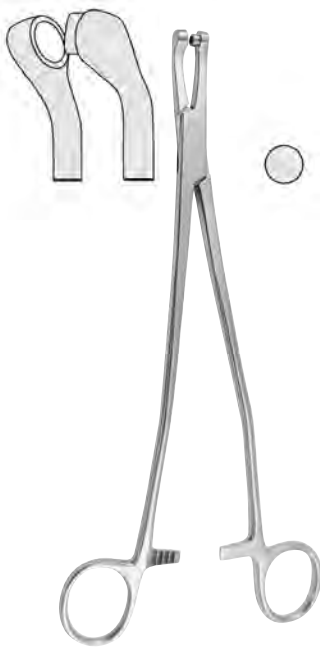


THOMS-GAYLOR
 21,0 cm, 8⁵/₈" **170.606.21**
 24,0 cm, 9¹/₂" **170.606.24**



SCHUBERT
 21,0 cm, 8¹/₄" **170.604.21**
 28,0 cm **170.604.28**

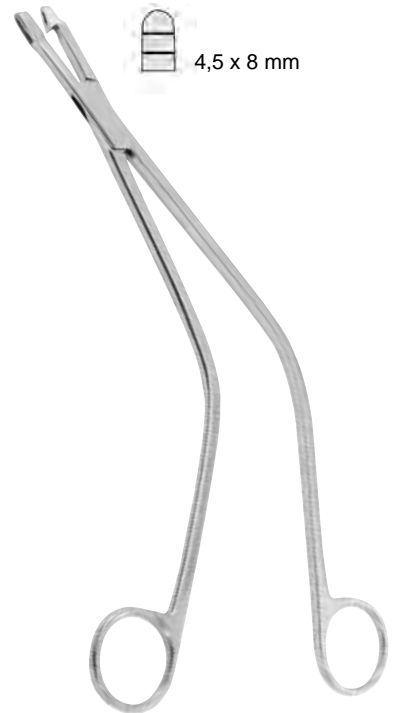




THOMS-GAYLOR
24,0 cm, 9½"
170.606.24



FAURE
21,0 cm, 8¼"
170.601.21



SCHUBERT
26,0 cm, 10¼"
170.605.26

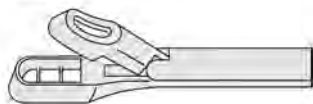


9 x 3 mm

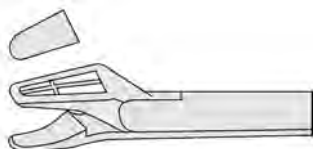


KEVORKIAN
25,0 cm, 10"
170.617.04

4,5 x 8 mm

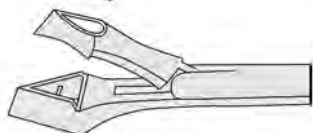


EPPENDORFER
23,0 cm, 8"
170.630.00



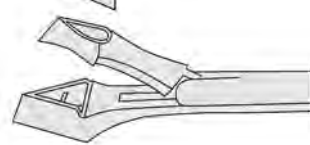
ALEXANDER
28,0 cm, 11"
170.613.28

4,0 mm



SCHUMACHER
24,0 cm, 9½"
170.615.01

6,0 mm



SCHUMACHER
24,0 cm, 9½"
170.615.02

4,5 x 8 mm



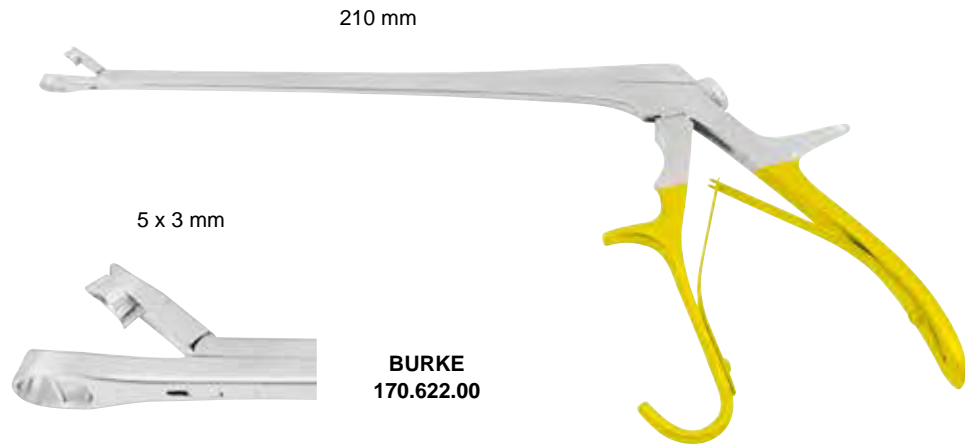
WITTNER
23,0 cm, 9"
170.619.23

4,5 x 8 mm



WITTNER
23,0 cm, 9"
170.618.23

Uterus-Biopsiezangen
 Cervical Biopsy and Specimen Forceps
 Pinzas saca-bocados para biopsia
 Pinze per la biopsia cervicale e da prelievo





WRIGLEY
28,0 cm, 11"
170.101.28



SIMPSON
30,0 cm, 11³/₄"
172.102.30



SIMPSON-BRAUN
33,0 cm, 13"
172.105.33



SIMPSON-BRAUN
36,0 cm, 14¹/₈"
172.105.36



SIMPSON-LUIKART
36,0 cm, 14¹/₈"
172.135.36



DE LEE
30,0 cm, 11³/₄"
172.107.30



DE LEE
36,0 cm, 14¹/₈"
172.108.36



DE LEE
38,0 cm, 15³/₈"
172.108.38



MC LEAN
36,0 cm, 14¹/₈"
172.145.36



KIELAND
41,0 cm, 16"
172.110.41



KIELAND-LUIKART
40,0 cm, 15³/₄"
172.127.40



PIPER
44,0 cm, 17¹/₄"
172.155.44



ELLIOT
32,0 cm, 12¹/₂"
172.115.32



ELLIOT
38,0 cm, 15"
172.115.38



NAEGELE
36,0 cm, 14¹/₈"
172.119.36



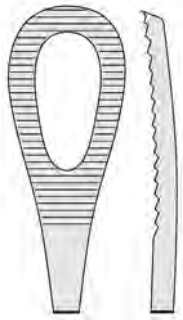
NAEGELE
40,0 cm, 15³/₄"
172.119.40



GREEN-ARMYTAGE
21,0 cm, 8¹/₄"
172.184.21



PESTALOZZA
30,0 cm, 11³/₄"
172.252.30



SAENGER
27,0 cm, 10⁵/₈"
172.242.27



SAENGER
27,0 cm, 10⁵/₈"
172.243.27



WINTER
28,0 cm, 11"



Fig. 1
172.244.01



Fig. 2
172.244.02



Fig. 3
172.244.03



Fig. 1
172.245.01

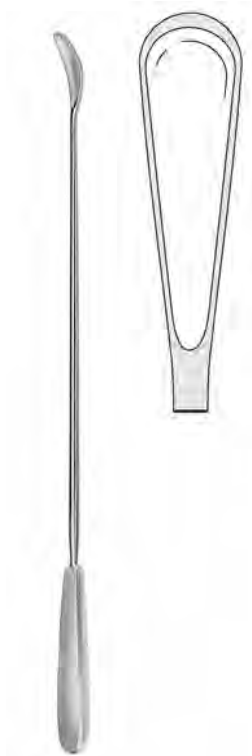


Fig. 2
172.245.02



Fig. 3
172.245.03

Plazentar- und Abortuszangen
Placenta and Ovum Forceps
Pinzas para aborto y placenta
Pinze per placenta e per ovaie



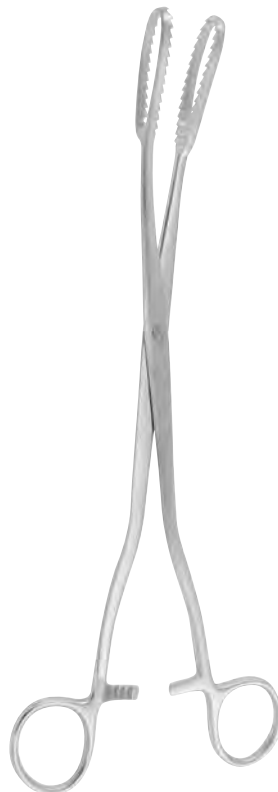
WALLICH
42,0 cm, 16 1/2"
172.256.42



MARTIN
34,0 cm, 13 3/8"
172.191.34



BIERER
28,0 cm
172.250.28



BIERER
28,0 cm
172.251.28

Vorbereitung, Dermatologie
Preparation, Dermatology
Preparación, Dermatología
Preparazione, Dermatalogia

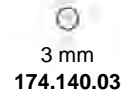
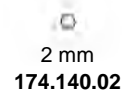


PIFFARD
 14,0 cm, 5³/₄"

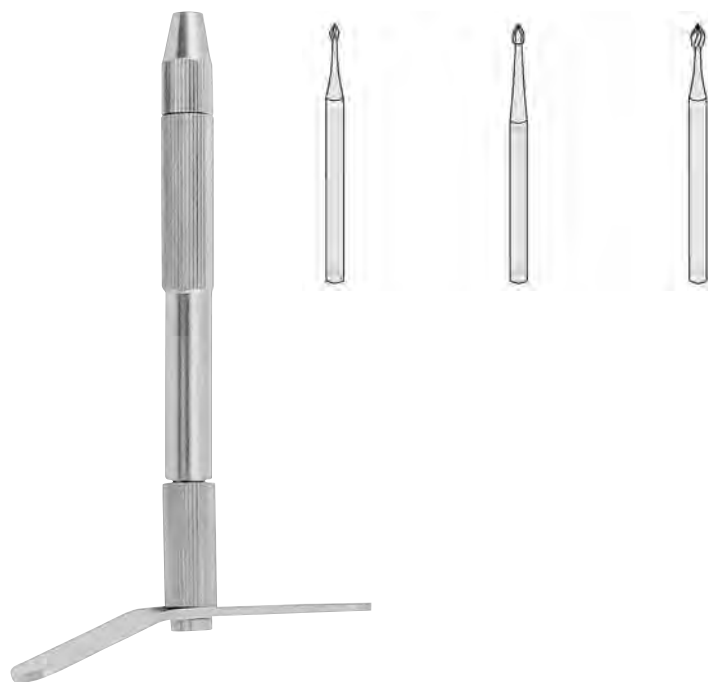
Lupusküretten
 Lupus curettes
 Curetas para lupus
 Raschiatoio per lupus



KEYES
 12,0 cm, 4³/₄"



KEYES
 12,0 cm, 4³/₄"
174.138.00



133.160.00
 komplett, complete,
 completo, completo,



UNNA
14,0 cm, 5³/₄"
174.113.14



UNNA
14,0 cm, 5³/₄"
174.115.14



SAALFELD
10,0 cm, 4"
174.121.10



SAALFELD
14,0 cm, 5³/₄"
174.122.14



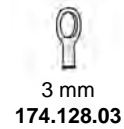
SCHAMBERG
10,0 cm, 4"
174.111.10



WALTON
14,0 cm, 5³/₄"
174.118.14



FOX
14,0 cm, 5³/₄"



Lupusküretten
Lupus cures
Curetas para lupus
Raschiatoio per lupus



133.175.01

17,0 cm, 6³/₄"
 133.175.00



WALTON
 16,0 cm, 6¹/₄"
 133.174.00



RADOLF
 13,5 cm, 5³/₈"
 133.162.13



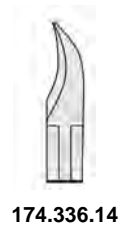
13,5 cm, 5³/₈"
 174.365.13



13,0 cm, 5"
 174.360.13



174.338.14



174.336.14

14,0 cm, 5¹/₂"

Sterilisation
Sterilization
Esterilización
Sterilizzazione



20,0 cm, 8"
128.102.20



CHEATTLE
27,0 cm, 10⁵/₈"
128.110.27



ROGGE
23,0 cm, 9"
128.130.23



MAYO
14,0 cm, 5¹/₂"
128.152.14



BUNT
12,0 cm, 4³/₄"
128.150.12



Ø 75 x 130 mm	188.142.06
Ø 75 x 175 mm	188.142.07
Ø 100 x 175 mm	188.142.08
Ø 100 x 200 mm	188.142.09



Ø 40,0 mm	188.130.04
Ø 60,0 mm	188.130.06
Ø 80,0 mm	188.130.08
Ø 100,0 mm	188.130.10
Ø 120,0 mm	188.130.12
Ø 150,0 mm	188.130.15



150 x 74 mm	0,75 l	88.133.16
160 x 65 mm	1,00 l	88.133.17
220 x 70 mm	2,00 l	88.133.22
230 x 80 mm	2,50 l	88.133.23
260 x 130 mm	4,50 l	88.133.24
255 x 115 mm	3,50 l	88.133.25
275 x 115 mm	5,00 l	88.133.27
300 x 105 mm	6,00 l	88.133.29
400 x 150 mm	14,00 l	88.133.38



170 mm	188.139.17
250 mm	188.135.25
275 mm	188.138.27

188.112.65
Ø 65 x 17 mm
Außen- und Innendose
Exterior and interior box
Caja exterior e interior
Scatola esterna es interiore

188.113.65
Ø 62 x 13 mm
Innendose allein
Interior box only
Caja interior, suelta
Scatola interiore sola



25 ccm
188.140.02

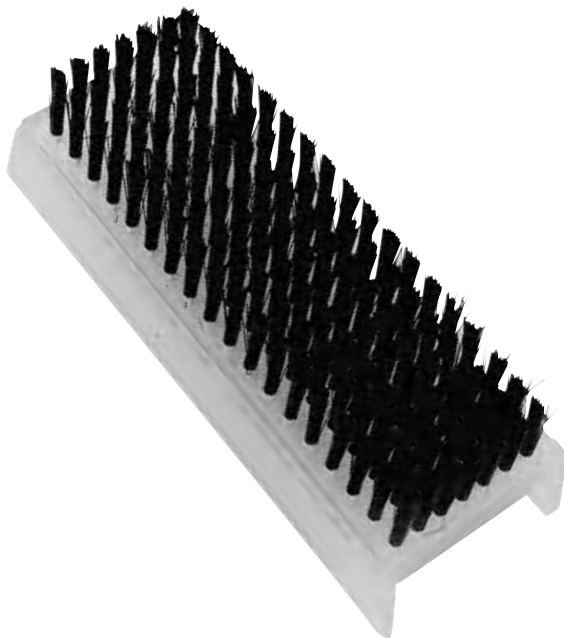


50 ccm
188.140.05



Bürstenspender für 10 Bürsten
Brush dispenser for 10 brushes
Distribuidor de cepillos para 10 cepillos
Distributore per 10 spazzole
260 x 155 x 65 mm

Bürstenspender für 20 Bürsten
Brush dispenser for 20 brushes
Distribuidor de cepillos para 20 cepillos
Distributore per 20 spazzole
270 x 240 x 65 mm
VH880.010



174.398.00
mehr als 400x autoklavierbar
more than 400 times autoclavable
esterilizable màs de 400 veces en autoclave
sterilizzabile piú di 400 volte in autoclave



VeHu-Medical GmbH
MRitter & Sohn GmbH
Dr. Karl Storz Straße. 25
D-78532 Tuttlingen

Tel. +49 (7461) 163311
Fax +49 (7461) 163312

info@vehu.de
www.vehu.de

